

— SYMPHONY®

TABLE ENVIRONMENTS

2023 PRICE LIST

version #101123

# table of contents

<b>Essential Information</b>	<b>4</b>
Wilsonart laminate finishes by number	6
Wilsonart laminate finishes by name	8
Formica laminate finishes by number	10
Formica laminate finishes by name	12
<b>Tables</b>	
Losa	14
Sala occasional	26
<b>Surfaces</b>	
surface and edge profile overview	28
surface shapes, dimensions, seating capacity	30
PVEA, PVRC, PVKN and PVKR round, square, rectangle	32
PVEA and PVKN 1 piece conference: rectangle, boat, oval, racetrack	36
PVEA and PVKN 2 piece conference: rectangle, boat, oval, racetrack	38
PVEA and PVKN 1 & 2 piece conference: arc trapezoid, arc rectangle	40
PVEA and PVKN media tops: half arc end, half boat, bullet, trapezoid	41
PVEA and PVKN media tops: Pic	42
PVEA quarter round, half round, crecent, trapezoid, corner-angled, corner-curved, corner-extended curved front, corner-120 degree, wedge	43
<b>Bases</b>	
T fixed, single column	46
fixed and nesting, double column	48
nesting, single column	49
nesting adjustable height	52
adjustable height	54
C fixed	60
nesting	62
adjustable height	64
X fixed	66
flip	74
adjustable height	77
four column	78
Y fixed, flip, and adj ht	80
personal	82
disc fixed	90
adjustable height	93
occasional	94
conference, under table media base and media walls	96
post and frame bases	126
<b>Power/data + Wire Management</b>	
power supply location chart	136
power/data modules (in alphabetical order)	138
wire management	158
grommets	160
modesty panels	162
<b>Accessories</b>	
locks	165
credenzas	166
lectern and misc accessories	168
<b>General Information</b>	
Terms & Conditions	172
Table Care and Maintenance	175
Environmental Statement & Solutions	176

# essential information

## Minimum order / Freight charge

Orders for \$5,000 or more list (contiguous U.S.): freight and minimum order charges included

Orders less than \$5000 list (contiguous U.S.)

Zone 1 \$200 net

Zone 2 \$260 net

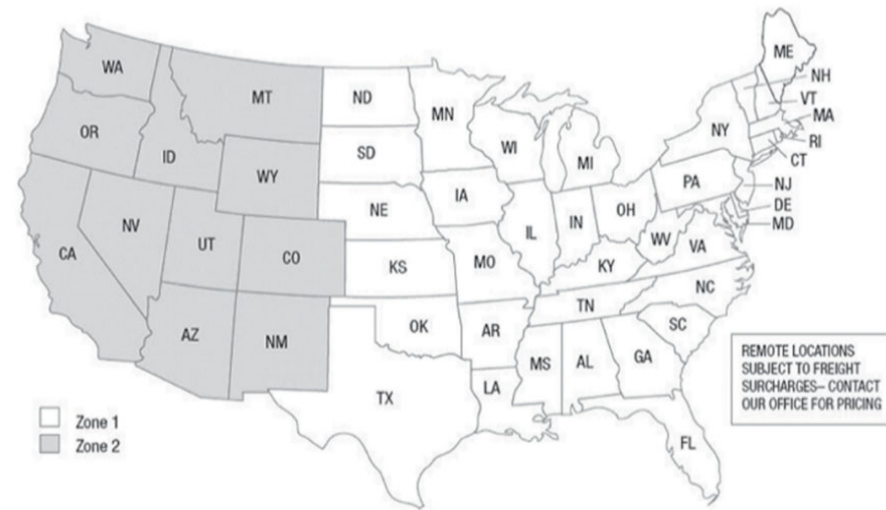

# tables

## Special Charges

Custom metal finish: contact [service@symphonytables.com](mailto:service@symphonytables.com) for a quote

## Lead Time

varies - please email [service@symphonytables.com](mailto:service@symphonytables.com) to confirm lead time

Please send purchase orders to [service@symphonytables.com](mailto:service@symphonytables.com)

## Symphony Contact Information

phone 866-507-7795

fax 888-683-0007

[service@symphonytables.com](mailto:service@symphonytables.com)

[www.SymphonyTables.com](http://www.SymphonyTables.com)

# surfaces

Wilsonart laminates by number  
+ matching 3mm edges (PVEA + PVKN)

Lam No	Laminate Name	Laminate Finish Grade		3mm edge	Lam No	Laminate Name	Laminate Finish Grade		3mm edge
		1	2				1	2	
1500	Grey	60		std stock	4846	Morro Zephyr	60		*F
1503	Putty	60		*F	4856	Cloud Zephyr	60		*R
1530	Beige	60		*R	4857	Shadow Zephyr	60		*R
1531	Light Beige	60		*R	4859	Spiced Zephyr	60		*R
1570	White	60		std stock	4860K	Silver Alchemy		7	*R
1572	Antique White	60		std stock	4861K	Gold Alchemy		7	*R
1573	Frosty White	60		std stock	4862	Sandy Topaz		7	*R
1595	Black	60		std stock	4869	Western White	60		*R
1787	Oxide	60		*R	4871	Western Suede	60		*R
2932	Almond Leather	60		*R	4876	Sheer Mesh	38		*R
4142	Grey Glace	60		*R	4877	Grey Mesh	38		std stock
4143	Neutral Glace	60		*R	4878	Pewter Mesh	38		*F
4166	Pampas	60		*R	4879	Steel Mesh	38		*F
4168	Grey Pampas	60		*R	4880	Carbon Mesh	38		*F
4170	Beige Pampas	60		*R	4882	Oiled Soapstone	38		*F
4588	Kalahari Topaz		7	*R	4883	Sable Soapstone	38		
4589K	Smoky Topaz		7	*R	4885	Green Soapstone	38		*R
4621	White Nebula	60		*F	4886	Pearl Soapstone	38		*R
4622	Grey Nebula	60		*F	4887	Tan Soapstone	38		*F
4623	Graphite Nebula	60		std stock	4888	Rustic Sate	38		*R
4630	Cloud Nebula	60		*R	4909	Ginseng Tea	60		
4651	Navy Legacy	60		*R	4911	Soft Gold Mesh	38		*R
4656	Bronze Legacy	60		*R	4912	Gilded Mesh	38		
4663	Tawny Legacy	60		*R	4915	Tangerine	60		*R
4667	Green Tigris	60		*R	4918	Sprout	60		*R
4669	Natural Tigris	60		*R	4939K	Vapor Strandz		18	*R
4674	Evening Tigris	60		*F	4940K	Astro Strandz		18	*R
4745	Maroocy Brush	60			4941K	Cosmic Strandz		18	*F
4746	Woolamai Brush	60			4996	High Rise	38		*R
4779	Pewter Brush	60		*F	7039K	Windsor Mahogany		78	std stock
4783	White Tigris	60		*R	7040K	Figured Mahogany		78	std stock
4794	Windswept Bronze	60		*R	7054	Wild Cherry	60		std stock
4795	Windswept Pewter	60		*R	7061	Natural Pear	60		*F
4796	Burnished Chestnut	60		*R	7110K	Montana Walnut		78	std stock
4810	Titanium EV	60		*R	7122K	Empire Mahogany		7	std stock
4811	Silicon EV	60		*R	7209K	Nepal Teak		78	std stock
4813	Nickel EV	60		*R	7806	Bannister Oak	60		std stock
4814	Tungsten EV	60		*R	7816	Solar Oak	60		std stock
4820	Carbon EV	60		*F	7850	Beigewood	60		std stock
4823	Antique Brush	60		*F	7909	Fusion Maple	60		std stock
4830K	Satin Stainless		18	std stock	7911	Manitoba Maple	60		std stock
4841	Desert Zephyr	60		*F	7919K	Amber Cherry		78	std stock
4842	Canyon Zephyr	60		*R	7921	Tuscan Walnut	38		*F
4843	Misted Zephyr	60		*R	7922	Brighton Walnut		7	std stock
4844	Loden Zephyr	60		*R	7923K	Versailles Anigre		7	*F
4845	Twilight Zephyr	60		*R	7924K	Biltmore Cherry		7	std stock

**std stock** - flex 3mm PVC edge stocked & available for any size/shape top at standard lead time  
 \*F - Flexible PVEA 3mm PVC edge available for an upcharge and a possible extended lead time depending on top sizes and quantity  
 \*R - Rigid PVEA 3mm PVC edge available for an upcharge and a possible extended lead time depending on top sizes and quantity - note that the rigid form prevents the use of this edge on curved or round tops  
**Please note that edge banding availability is subject to change.**  
 Email [service@symphonytables.com](mailto:service@symphonytables.com) to check pricing and lead time prior to ordering for \*F and \*R edge banding.

# surfaces

Wilsonart laminates by number  
+ matching 3mm edges (PVEA + PVKN)

Lam No	Laminate Name	Laminate Finish Grade		3mm edge	Lam No	Laminate Name	Laminate Finish Grade		3mm edge
		1	2				1	2	
7925	Monticello Maple	38		std stock	7987	Palisades Oak	38		*R
7928	Castle Oak	38		*F	7988	Hibiscus Cherry	38		
7929	Huntington Maple	38		std stock	7989	Persian Cherry	38		
7933K	Cafelle		7	std stock	7990	Mission Maple	38		*R
7935K	Shaker Cherry		7		7991	Neowalnut	38		*R
7936K	Williamsburg Cherry		7	std stock	7992	Pinnacle Walnut	38		std stock
7937	River Cherry	38		std stock	7993	Florence Walnut	38		*R
7938	New Age Oak	38		*R	7994	Lowell Ash	38		*R
7939K	Blond Echo		18	std stock	7995	Sterling Ash	38		*R
7941K	Tan Echo		18	std stock	7996	Natural Recon	38		*R
7942K	Cocobala		7	std stock	7997	Ebony Recon	38		std stock
7943K	Colombian Walnut		7	std stock	7998K	Low Line		18	
7944K	Madagascar		1		7999K	Field Elm		12	std stock
7945K	Xanadu		18	*R	8200K	White Driftwood		16	
7946	Brazilwood	38		std stock	8201K	Grey Elm		12	std stock
7947K	Rio		18	*R	8204K	Weathered Char		16	*R
7948K	Mambo		7	*F	8205K	Ebony Char		16	
7949K	Asian Night		18	std stock	8206K	Saddle Oak		16	
7951K	Asian Sun		18	*R	8207K	Branded Oak		16	*R
7952K	Asian Sand		18	std stock	8208K	Fawn Cypress		16	*R
7953	Harvest Maple	38		std stock	10734	Limber Maple	60		std stock
7954	Natural Rift	38		*R	10745	Fonthill Pear	60		std stock
7957K	Zanzibar		78	std stock	10776	Kensington Maple	60		std stock
7959K	Hampton Walnut		78	std stock	D12	Regimental Red		18	*R
7960K	Studio Teak		18	std stock	D14	Port	60		*F
7962K	Aloe		18	*R	D25	Atlantis	60		std stock
7964K	Skyline Walnut		12	std stock	D30	Natural Almond	60		std stock
7965K	Walnut Heights		12	std stock	D307	Hollyberry	60		*F
7966K	5th Ave. Elm		12	*R	D315	Platinum	60		std stock
7967K	Park Elm		12	*R	D321	Brittany Blue	60		*F
7968K	Loft Oak		12	*R	D327	Pepperdust	60		std stock
7969K	Warehouse Oak		12		D337	Pebble	60		std stock
7970K	High Line		18	std stock	D354	Designer White	60		std stock
7971K	Uptown Walnut		12	*R	D379	Indigo	60		*R
7972K	Truss Maple		12		D381	Fashion Grey	60		*F
7973K	Old Mill Oak		12	*R	D403	White Sand	60		*R
7975K	Raw Chestnut		12		D417	Lapis Blue	60		*R
7976K	White Cypress		12	*R	D427	Linen	60		std stock
7977K	White Barn		12	*R	D431	Alabaster	60		std stock
7980K	ZebraWood		18	*F	D439	Wallaby	60		std stock
7981K	Landmark Wood		12	*R	D495	Coffee Bean	60		std stock
7982	Buka Bark	38		*R	D50	Khaki Brown	60		std stock
7983	Boardwalk Oak	38		*R	D90	North Sea	60		std stock
7984	Mangalore Mango	38		*R	D91	Slate Grey	60		std stock
7985	Morelia Mango	38		*R	D92	Dove Grey	60		std stock
7986	Pasadena Oak	38		*R	D96	Shadow	60		std stock

Please note: additional laminates and finishes may be available with additional fees and/or extended lead times  
 Contact Symphony for pricing and lead time information: [service@symphonytables.com](mailto:service@symphonytables.com)  
 Laminates and specific finishes may be discontinued by Formica or Wilsonart. For the most up to date information, contact your Formica or Wilsonart representative.

# surfaces

Wilsonart laminates by name

+ matching 3mm edges (PVEA + PVKN)

Laminate Name	Lam No	Laminate Finish Grade			Laminate Name	Lam No	Laminate Finish Grade		
		1	2	3mm edge			1	2	3mm edge
5th Ave. Elm	7966K		12	*R	Fawn Cypress	8208K		16	*R
Alabaster	D431	60		std stock	Field Elm	7999K		12	std stock
Almond Leather	2932	60		*R	Figured Mahogany	7040K		78	std stock
Aloe	7962K		18	*R	Florence Walnut	7993	38		*R
<b>Amber Cherry</b>	<b>7919K</b>		<b>78</b>	<b>std stock</b>	Fonthill Pear	10745	60		std stock
Antique Brush	4823	60		*F	<b>Frosty White</b>	<b>1573</b>	<b>60</b>		<b>std stock</b>
Antique White	1572	60		std stock	<b>Fusion Maple</b>	<b>7909</b>	<b>60</b>		<b>std stock</b>
<b>Asian Night</b>	<b>7949K</b>		<b>18</b>	<b>std stock</b>	Gilded Mesh	4912	38		
Asian Sand	7952K		18	std stock	Ginseng Tea	4909	60		
Asian Sun	7951K		18	*R	Gold Alchemy	4861K		7	*R
Astro Strandz	4940K		18	*R	Graphite Nebula	4623	60		std stock
Atlantis	D25	60		std stock	Green Soapstone	4885	38		*R
Bannister Oak	7806	60		std stock	Green Tigris	4667	60		*R
Beige	1530	60		*R	Grey	1500	60		std stock
Beige Pampas	4170	60		*R	Grey Elm	8201K		12	std stock
Beigewood	7850	60		std stock	Grey Glace	4142	60		*R
Biltmore Cherry	7924K		7	std stock	Grey Mesh	4877	38		std stock
<b>Black</b>	<b>1595</b>	<b>60</b>		<b>std stock</b>	Grey Nebula	4622	60		*F
Blond Echo	7939K		18	std stock	Grey Pampas	4168	60		*R
Boardwalk Oak	7983	38		*R	Hampton Walnut	7959K		78	std stock
Branded Oak	8207K		16	*R	Harvest Maple	7953	38		std stock
Brazilwood	7946	38		std stock	Hibiscus Cherry	7988	38		
Brighton Walnut	7922		7	std stock	High Line	7970K		18	std stock
Brittany Blue	D321	60		*F	High Rise	4996	38		*R
Bronze Legacy	4656	60		*R	Hollyberry	D307	60		*F
Buka Bark	7982	38		*R	Huntington Maple	7929	38		std stock
Burnished Chestnut	4796	60		*R	Indigo	D379	60		*R
<b>Cafelle</b>	<b>7933K</b>		<b>7</b>	<b>std stock</b>	Kalahari Topaz	4588		7	*R
Canyon Zephyr	4842	60		*R	<b>Kensington Maple</b>	<b>10776</b>	<b>60</b>		<b>std stock</b>
Carbon EV	4820	60		*F	<b>Khaki Brown</b>	<b>D50</b>	<b>60</b>		<b>std stock</b>
Carbon Mesh	4880	38		*F	Landmark Wood	7981K		12	*R
Castle Oak	7928	38		*F	Lapis Blue	D417	60		*R
Cloud Nebula	4630	60		*R	Light Beige	1531	60		*R
Cloud Zephyr	4856	60		*R	Limber Maple	10734	60		std stock
Cocobala	7942K		7	std stock	Linen	D427	60		std stock
<b>Coffee Bean</b>	<b>D495</b>	<b>60</b>		<b>std stock</b>	Loden Zephyr	4844	60		*R
<b>Colombian Walnut</b>	<b>7943K</b>		<b>7</b>	<b>std stock</b>	Loft Oak	7968K		12	*R
Cosmic Strandz	4941K		18	*F	Low Line	7998K		18	
Desert Zephyr	4841	60		*F	Lowell Ash	7994	38		*R
<b>Designer White</b>	<b>D354</b>	<b>60</b>		<b>std stock</b>	Madagascar	7944K		1	
Dove Grey	D92	60		std stock	Mambo	7948K		7	*F
Ebony Char	8205K		16		Mangalore Mango	7984	38		*R
Ebony Recon	7997	38		std stock	Manitoba Maple	7911	60		std stock
Empire Mahogany	7122K		7	std stock	Maroochy Brush	4745	60		
Evening Tigris	4674	60		*F	Mission Maple	7990	38		*R
Fashion Grey	D381	60		*F	Misted Zephyr	4843	60		*R

std stock - flex 3mm PVC edge stocked & available for any size/shape top at standard lead time  
 \*F - Flexible PVEA 3mm PVC edge available for an upcharge and a possible extended lead time depending on top sizes and quantity  
 \*R - Rigid PVEA 3mm PVC edge available for an upcharge and a possible extended lead time depending on top sizes and quantity - note that the rigid form prevents the use of this edge on curved or round tops  
**Please note that edge banding availability is subject to change.**  
 Email [service@symphonytables.com](mailto:service@symphonytables.com) to check pricing and lead time prior to ordering for \*F and \*R edge banding.

# surfaces

Wilsonart laminates by name

+ matching 3mm edges (PVEA + PVKN)

Laminate Name	Lam No	Laminate Finish Grade			Laminate Name	Lam No	Laminate Finish Grade		
		1	2	3mm edge			1	2	3mm edge
Montana Walnut	7110K		78	std stock	Silicon EV	4811	60		*R
<b>Monticello Maple</b>	<b>7925</b>	<b>38</b>		<b>std stock</b>	Silver Alchemy	4860K		7	*R
Morelia Mango	7985	38		*R	<b>Skyline Walnut</b>	<b>7964K</b>		<b>12</b>	<b>std stock</b>
Morro Zephyr	4846	60		*F	<b>Slate Grey</b>	<b>D91</b>	<b>60</b>		<b>std stock</b>
Natural Almond	D30	60		std stock	Smoky Topaz	4589K		7	*R
Natural Pear	7061	60		*F	Soft Gold Mesh	4911	38		*R
Natural Recon	7996	38		*R	Solar Oak	7816	60		std stock
Natural Rift	7954	38		*R	Spiced Zephyr	4859	60		*R
Natural Tigris	4669	60		*R	Sprout	4918	60		*R
Navy Legacy	4651	60		*R	Steel Mesh	4879	38		*F
Neowalnut	7991	38		*R	Sterling Ash	7995	38		*R
Nepal Teak	7209K		78	std stock	<b>Studio Teak</b>	<b>7960K</b>		<b>18</b>	<b>std stock</b>
Neutral Glace	4143	60		*R	Tan Echo	7941K		18	std stock
New Age Oak	7938	38		*R	Tan Soapstone	4887	38		*F
Nickel EV	4813	60		*R	Tangerine	4915	60		*R
North Sea	D90	60		std stock	Tawny Legacy	4663	60		*R
Oiled Soapstone	4882	38		*F	Titanium EV	4810	60		*R
Old Mill Oak	7973K		12	*R	Truss Maple	7972K		12	
Oxide	1787	60		*R	Tungsten EV	4814	60		*R
Palisades Oak	7987	38		*R	Tuscan Walnut	7921	38		*F
Pampas	4166	60		*R	Twilight Zephyr	4845	60		*R
Park Elm	7967K		12	*R	Uptown Walnut	7971K		12	*R
Pasadena Oak	7986	38		*R	Vapor Strandz	4939K		18	*R
Pearl Soapstone	4886	38		*R	Versailles Anigre	7923K		7	*F
Pebble	D337	60		std stock	Wallaby	D439	60		std stock
Pepperdust	D327	60		std stock	<b>Walnut Heights</b>	<b>7965K</b>		<b>12</b>	<b>std stock</b>
Persian Cherry	7989	38			Warehouse Oak	7969K		12	
Pewter Brush	4779	60		*F	Weathered Char	8204K		16	*R
Pewter Mesh	4878	38		*F	Western Suede	4871	60		*R
Pinnacle Walnut	7992	38		std stock	Western White	4869	60		*R
Platinum	D315	60		std stock	White	1570	60		std stock
Port	D14	60		*F	White Barn	7977K		12	*R
Putty	1503	60		*F	White Cypress	7976K		12	*R
Raw Chestnut	7975K		12		White Driftwood	8200K		16	
Regimental Red	D12		18	*R	White Nebula	4621	60		*F
Rio	7947K		18	*R	White Sand	D403	60		*R
<b>River Cherry</b>	<b>7937</b>	<b>38</b>		<b>std stock</b>	White Tigris	4783	60		*R
Rustic Sate	4888	38		*R	<b>Wild Cherry</b>	<b>7054</b>	<b>60</b>		<b>std stock</b>
Sable Soapstone	4883	38			Williamsburg Cherry	7936K		7	std stock
Saddle Oak	8206K		16		<b>Windsor Mahogany</b>	<b>7039K</b>		<b>78</b>	<b>std stock</b>
Sandy Topaz	4862		7	*R	Windswept Bronze	4794	60		*R
Satin Stainless	4830K		18	std stock	Windswept Pewter	4795	60		*R
<b>Shadow</b>	<b>D96</b>	<b>60</b>		<b>std stock</b>	Woolamai Brush	4746	60		
Shadow Zephyr	4857	60		*R	Xanadu	7945K		18	*R
Shaker Cherry	7935K		7		Zanzibar	7957K		78	std stock
Sheer Mesh	4876	38		*R	Zebrawood	7980K		18	*F

Please note: additional laminates and finishes may be available with additional fees and/or extended lead times  
 Contact Symphony for pricing and lead time information: [service@symphonytables.com](mailto:service@symphonytables.com)  
 Laminates and specific finishes may be discontinued by Formica or Wilsonart. For the most up to date information, contact your Formica or Wilsonart representative.

# surfaces

Formica laminates by number  
+ matching 3mm edges (PVEA + PVKN)

Lam No	Laminate Name	Laminate Finish Grade			Lam No	Laminate Name	Laminate Finish Grade		
		1	2	3mm edge			1	2	3mm edge
118	Finnish Oak	58		*F	2200	Dark Chocolate	58		*R
204	Butcherblock Maple	58			2297	Terril	58		*R
299	Ebony Oxide	58		*R	2770	Sarum Grey	58		*R
300	Sail White Oxide	58			2962	Clementine	58		
303	Antique White Oxide	58		*R	3202	Otter	58		*R
346	Natural Oak	58		*F	3209	Sol	58		*R
459	Brite White	58		std stock	3453	Parquet Latte	58		
463	Sail White	58		*F	3485	Black Walnut	58		*F
464	Graystone	58		std stock	3505	Storm Solidz	58		*R
503	Stone Grafix	58		std stock	3517	Sand Crystall	58		
507	Folkstone Grafix	58			3526	Travertine	58		
515	Graphite Grafix	58		*F	3687	Autumn Indian Slate	58		*R
692	Folkstone Celesta	58		*R	3690	Basalt Slate	58		*R
756	Natural Maple	58		std stock	3692	Labrador Granite	58		
758	Blossom Cherrywood	58			3696	Shoji Screen	58		
827	White Onyx		***90		3698	Beluga Beige	58		*R
837	Graphite	58		std stock	5281	Dogbone White	58		
839	Stop Red	58		*F	5323	Nocturne	58		
845	Spectrum Red	58		*F	5342	Earth	58		*R
851	Spectrum Blue	58		*F	5349	Fossil	58		*R
858	Pumice	58		std stock	5487	Oiled Walnut	58		*R
863	Myriad Ribbonwood	58		*F	5488	Smoky Brown Pear	58		*F
873	Ebony Ribbonwood	58		*F	5489	Espresso Pear	58		*F
899	Desert Beige	58		*F	5875	Neutral Weft	58		*R
902	Platinum	58		std stock	5880	Earthen Warp	58		*R
909	Black	58		std stock	5881	Chocolate Warp	58		*R
912	Storm	58		std stock	5882	Citadel Warp	58		*R
914	Marine Blue	58		*R	5883	Pecan Woodline	58		*F
918	Neutral White	58		*F	5884	Chestnut Woodline	58		*R
920	Almond	58		std stock	5886	Sorrel Cherry	43, 58		*F
923	Surf	58		*F	5887	Millennium Oak	58		*R
927	<b>Folkstone</b>	<b>58</b>		<b>std stock</b>	5904	Wild Cherry	43, 58		*F
928	Mouse	58		*F	6206	Planked Deluxe Pear	43, 58		*R
929	Oyster Gray	58		*R	6208	Glamour Cherry	43, 58		*F
932	Antique White	58		std stock	6209	Prestige Walnut	43		std stock
933	Mission White	58		*F	6212	Wheat Strand	58		*F
934	Pearl	58		*R	6226	Ivory Kashmir	58		
949	White	58		std stock	6306	Wenge Strand	58		*R
961	Fog	58		std stock	6307	Burnt Strand	58		*R
967	Hunter Green	58			6314	Neo Cloud	58		
969	Navy Blue	58		*R	6366	Paloma Dark Gray	58		*R
1097	Citadel	58		*R	6402	Thermo Walnut	43		*F
1150	Vosges Pear	43		*F	6417	Elemental Oxide	58		
1485	Chrome Yellow	58			6437	Chalked Knotty Ash	58		
1517	Eggplant	58			6440	Smoked Knotty Ash	58		*F
1519	Blackened Bronze	58			6447	Sarum Duotex	58		*R
1520	Infinity	58		*R	6448	Infinity Duotex	58		*R
1994	Fox	58		*R	6449	Charcoal Duotex	58		

std stock - flex 3mm PVC edge stocked & available for any size/shape top at standard lead time  
 \*F - Flexible PVEA 3mm PVC edge available for an upcharge and a possible extended lead time depending on top sizes and quantity  
 \*R - Rigid PVEA 3mm PVC edge available for an upcharge and a possible extended lead time depending on top sizes and quantity - note that the rigid form prevents the use of this edge on curved or round tops  
 Please note that edge banding availability is subject to change.  
 Email [service@symphonytables.com](mailto:service@symphonytables.com) to check pricing and lead time prior to ordering for \*F and \*R edge banding.

# surfaces

Formica laminates by number  
+ matching 3mm edges (PVEA + PVKN)

Lam No	Laminate Name	Laminate Finish Grade			Lam No	Laminate Name	Laminate Finish Grade		
		1	2	3mm edge			1	2	3mm edge
6473	Folkstone Hex	58			8826	Neutral Twill	58		std stock
6474	Storm Hex	58			8827	Sarum Twill	58		*F
6475	Elemental Blue Steel	58			8828	Earthen Twill	58		*F
6698	Paloma Polar	58		*R	8829	Graphite Twill	58		*F
6729	Paloma Bisque	58		*R	8830	Elemental Concrete	58		
6901	Vibrant Green	58		*R	8831	Elemental Stone	58		*R
6902	Grenadine	58			8839	Ashen Ribbonwood	58		*F
6903	Cassis	58		*R	8841	White Ash		***WR	*F
6907	Amarena	58			8842	Weathered Ash		***WR	*F
6920	Mineral Spa	58		*R	8843	Natural Ash		***WR	
6925	Maple Woodline	58		*R	8844	Aged Ash		***WR	*F
6926	Smoky Walnut Woodline	58		*R	8845	Bleached Legno	58		std stock
6932	Macchiato Walnut	58		*F	8846	Oiled Legno	58		*F
6942	Charcoal Boomerang	58			8848	Blackened Legno	58		std stock
7008	Acajou Mahogany	43, 58		*R	8849	Natural Teak	58		*F
7012	Amber Maple	58		std stock	8858	Just Rose	58		
7014	Colorado Slate	58		*R	8905	Waxed Maple	58		
7018	Navy Grafix	58		*R	8906	Danish Maple	58		*R
7022	Natural Canvas	58			8917	Rolled Steel	58		
7197	Dover White	58		std stock	8918	Blackened Steel	58		
7213	Earth Wash	58		*R	8919	Bronzed Steel	58		
7264	Lime Stone	58			8956	Bubble Science	58		
7265	Sand Stone	58			8957	Bubble Organic	58		
7267	Concrete Stone	58			8958	Bubble Art	58		
7288	Ginger Root Maple	58		*F	9012	Ebony	58		*R
7481	Natural Birch	58		*R	9256	Auburn Maple	58		
7484	Cherry Birch	58		*R	9257	Glow Maple	58		
7494	Carrara Envision	58		*R	9283	Walnut Riftwood		***NG	*F
7708	Flax Gauze	58		*R	9285	White Twill	58		*F
7734	Jamocho Granite	58			9311	Silver Oak Herringbone	58		
7735	Portico Marble	58		*R	9312	Planked Urban Oak	58		*F
7738	Cognac Maple	58		*F	9476	White Ice Granite	43		
7739	Cocoa Maple	58		*F	9480	Salvage Planked Elm	58		
7747	Pencil Wood	58		*R	86992	Hard Rock Maple	58		std stock
7759	Select Cherry	43		std stock					
7812	MDF Solidz	58		*R					
7813	Cardboard Solidz	58		*R					
7897	Spectrum Green	58							
7966	New Burgundy	58							
8751	Mojave	58							
8792	Winter Sky	58		*R					
8793	Green Slate	58							
8794	Enamel	58							
8795	Matrix Blue	58							
8814	Denim Twill	58							
8820	Leaf Green	58		*R					
8821	Just Blue	58		*R					
8824	White Drops	58		*R					

Please note: additional laminates and finishes may be available with additional fees and/or extended lead times  
 Contact Symphony for pricing and lead time information: [service@symphonytables.com](mailto:service@symphonytables.com)  
 Laminates and specific finishes may be discontinued by Formica or Wilsonart. For the most up to date information, contact your Formica or Wilsonart representative.

\*\*\*Note that waste fees may apply for Formica NG, WR or 90 finishes. Please email [service@symphonytables.com](mailto:service@symphonytables.com) for a quote.

# surfaces

Formica laminates by name  
+ matching 3mm edges (PVEA + PVKN)

Laminate Name	Lam No	Laminate Finish Grade			Laminate Name	Lam No	Laminate Finish Grade		
		1	2	3mm edge			1	2	3mm edge
Acajou Mahogany	7008	43, 58		*R	Dover White	7197	58		std stock
Aged Ash	8844		***WR	*F	Earth	5342	58		*R
Almond	920	58		std stock	Earth Wash	7213	58		*R
Amarena	6907	58			Earthen Twill	8828	58		*F
Amber Maple	7012	58		std stock	Earthen Warp	5880	58		*R
Antique White	932	58		std stock	Ebony	9012	58		*R
Antique White Oxide	303	58		*R	Ebony Oxide	299	58		*R
Ashen Ribbonwood	8839	58		*F	Ebony Ribbonwood	873	58		*F
Auburn Maple	9256	58			Eggplant	1517	58		
Autumn Indian Slate	3687	58		*R	Elemental Blue Steel	6475	58		
Basalt Slate	3690	58		*R	Elemental Concrete	8830	58		
Beluga Beige	3698	58		*R	Elemental Concrete	8830	58		
Black	909	58		std stock	Elemental Oxide	6417	58		
Black Walnut	3485	58		*F	Elemental Stone	8831	58		*R
Blackened Bronze	1519	58			Enamel	8794	58		
Blackened Legno	8848	58		std stock	Espresso Pear	5489	58		*F
Blackened Steel	8918	58			Finnish Oak	118	58		*F
<b>Bleached Legno</b>	<b>8845</b>	<b>58</b>		<b>std stock</b>	Flax Gauze	7708	58		*R
Blossom Cherrywood	758	58			Fog	961	58		std stock
Brite White	459	58		std stock	<b>Folkstone</b>	<b>927</b>	<b>58</b>		<b>std stock</b>
Bronzed Steel	8919	58			Folkstone Celesta	692	58		*R
Bubble Art	8958	58			Folkstone Grafix	507	58		
Bubble Organic	8957	58			Folkstone Hex	6473	58		
Bubble Science	8956	58			Fossil	5349	58		*R
Burnt Strand	6307	58		*R	Fox	1994	58		*R
Butcherblock Maple	204	58			Ginger Root Maple	7288	58		*F
Cardboard Solidz	7813	58		*R	Glamour Cherry	6208	43, 58		*F
Carrara Envision	7494	58		*R	Glow Maple	9257	58		
Cassis	6903	58		*R	Graphite	837	58		std stock
Chalked Knotty Ash	6437	58			Graphite Grafix	515	58		*F
Charcoal Boomerang	6942	58			Graphite Twill	8829	58		*F
Charcoal Duotex	6449	58			Graystone	464	58		std stock
Cherry Birch	7484	58		*R	Green Slate	8793	58		
Chestnut Woodline	5884	58		*R	Grenadine	6902	58		
Chocolate Warp	5881	58		*R	Hard Rock Maple	86992	58		std stock
Chrome Yellow	1485	58			Hunter Green	967	58		
Citadel	1097	58		*R	Infinity	1520	58		*R
Citadel Warp	5882	58		*R	Infinity Duotex	6448	58		*R
Clementine	2962	58			Ivory Kashmir	6226	58		
Cocoa Maple	7739	58		*F	Jamocha Granite	7734	58		
Cognac Maple	7738	58		*F	Just Blue	8821	58		*R
Colorado Slate	7014	58		*R	Just Rose	8858	58		
Concrete Stone	7267	58			Labrador Granite	3692	58		
Danish Maple	8906	58		*R	Leaf Green	8820	58		*R
Dark Chocolate	2200	58		*R	Lime Stone	7264	58		
Denim Twill	8814	58			Macchiato Walnut	6932	58		*F
Desert Beige	899	58		*F	Maple Woodline	6925	58		*R
Dogbone White	5281	58			Marine Blue	914	58		*R
					Matrix Blue	8795	58		

**std stock** - flex 3mm PVC edge stocked & available for any size/shape top at standard lead time  
 \*F - Flexible PVEA 3mm PVC edge available for an upcharge and a possible extended lead time depending on top sizes and quantity  
 \*R - Rigid PVEA 3mm PVC edge available for an upcharge and a possible extended lead time depending on top sizes and quantity - note that the rigid form prevents the use of this edge on curved or round tops  
**Please note that edge banding availability is subject to change.**  
 Email [service@symphonytables.com](mailto:service@symphonytables.com) to check pricing and lead time prior to ordering for \*F and \*R edge banding.

# surfaces

Formica laminates by name  
+ matching 3mm edges (PVEA + PVKN)

Laminate Name	Lam No	Laminate Finish Grade			Laminate Name	Lam No	Laminate Finish Grade		
		1	2	3mm edge			1	2	3mm edge
MDF Solidz	7812	58		*R	Shoji Screen	3696	58		
Millennium Oak	5887	58		*R	Silver Oak Herringbone	9311	58		
Mineral Spa	6920	58		*R	Smoked Knotty Ash	6440	58		*F
Mission White	933	58		*F	Smoky Brown Pear	5488	58		*F
Mojave	8751	58			Smoky Walnut Woodline	6926	58		*R
Mouse	928	58		*F	Sol	3209	58		*R
Myriad Ribbonwood	863	58		*F	Sorrel Cherry	5886	43, 58		*F
Natural Ash	8843		***WR		Spectrum Blue	851	58		*F
Natural Birch	7481	58		*R	Spectrum Green	7897	58		
Natural Canvas	7022	58			Spectrum Red	845	58		*F
Natural Maple	756	58		std stock	Stone Grafix	503	58		std stock
Natural Oak	346	58		*F	Stop Red	839	58		*F
Natural Teak	8849	58		*F	Storm	912	58		std stock
Navy Blue	969	58		*R	Storm Hex	6474	58		
Navy Grafix	7018	58		*R	Storm Solidz	3505	58		*R
Neo Cloud	6314	58			Surf	923	58		*F
<b>Neutral Twill</b>	<b>8826</b>	<b>58</b>		<b>std stock</b>	Terril	2297	58		*R
Neutral Weft	5875	58		*R	Thermo Walnut	6402	43		*F
Neutral White	918	58		*F	Travertine	3526	58		
New Burgundy	7966	58			Vibrant Green	6901	58		*R
Nocturne	5323	58			Vosges Pear	1150	43		*F
Oiled Legno	8846	58		*F	Walnut Riftwood	9283		***NG	*F
Oiled Walnut	5487	58		*R	Waxed Maple	8905	58		
Otter	3202	58		*R	Weathered Ash	8842		***WR	*F
Oyster Gray	929	58		*R	Wenge Strand	6306	58		*R
Paloma Bisque	6729	58		*R	Wheat Strand	6212	58		*F
Paloma Dark Gray	6366	58		*R	White	949	58		std stock
Paloma Polar	6698	58		*R	White Ash	8841		***WR	*F
Parquet Latte	3453	58			White Drops	8824	58		*R
Pearl	934	58		*R	White Ice Granite	9476	43		
Pecan Woodline	5883	58		*F	White Onyx	827		***90	
Pencil Wood	7747	58		*R	White Twill	9285	58		*F
Planked Deluxe Pear	6206	43, 58		*R	Wild Cherry	5904	43, 58		*F
Planked Urban Oak	9312	58		*F	Winter Sky	8792	58		*R
Platinum	902	58		std stock					
Portico Marble	7735	58		*R					
Prestige Walnut	6209	43		std stock					
Pumice	858	58		std stock					
Rolled Steel	8917	58							
Sail White	463	58		*F					
Sail White Oxide	300	58							
Salvage Planked Elm	9480	58							
Sand Crystal	3517	58							
Sand Stone	7265	58							
Sarum Duotex	6447	58		*R					
Sarum Grey	2770	58		*R					
Sarum Twill	8827	58		*F					
Select Cherry	7759	43		std stock					

Please note: additional laminates and finishes may be available with additional fees and/or extended lead times  
 Contact Symphony for pricing and lead time information: [service@symphonytables.com](mailto:service@symphonytables.com)  
 Laminates and specific finishes may be discontinued by Formica or Wilsonart. For the most up to date information, contact your Formica or Wilsonart representative.

\*\*\*Note that waste fees may apply for Formica NG, WR or 90 finishes. Please email [service@symphonytables.com](mailto:service@symphonytables.com) for a quote.

# tables

Losa seated height  
12"H stretcher(s)

For complete model number:

1. insert 2 letter stretcher option code:

**XC** - (1) 12" high stretcher centered under each piece of the top

**XO** - (1) 12" high stretcher offset under each piece of the top

\*specify offset stretcher placement - 1" or 6" from approach edge of top

**2XC** - (2) 12" high stretchers centered under each piece of the top

stretchers come standard 6" apart for tables that are 24", 30" or 36" deep

Losa 30"H table			dimensions	1, 2 or 3 piece top	model no.	grade 1 list	grade 2 list
<b>XC</b> (1) 12"H stretcher centered under each piece of the top		<b>2XC</b> (2) 12"H stretchers centered under each piece of the top 6" apart	24 x 48 x 30H	1	TLLOS24048S - PV	1,830	2,070
			24 x 54 x 30H	1	TLLOS24054S - PV	1,900	2,160
			24 x 60 x 30H	1	TLLOS24060S - PV	1,920	2,180
			24 x 66 x 30H	1	TLLOS24066S - PV	2,010	2,290
			24 x 72 x 30H	1	TLLOS24072S - PV	2,030	2,310
			24 x 84 x 30H	1	TLLOS24084S - PV	2,240	2,550
			24 x 96 x 30H	1	TLLOS24096S - PV	2,340	2,660
			30 x 48 x 30H	1	TLLOS30048S - PV	1,930	2,190
			30 x 54 x 30H	1	TLLOS30054S - PV	2,010	2,290
			30 x 60 x 30H	1	TLLOS30060S - PV	2,090	2,380
			30 x 66 x 30H	1	TLLOS30066S - PV	2,160	2,470
			30 x 72 x 30H	1	TLLOS30072S - PV	2,180	2,490
30 x 84 x 30H	1	TLLOS30084S - PV	2,410	2,740			
30 x 96 x 30H	1	TLLOS30096S - PV	2,500	2,860			
<b>XO</b> (1) 12"H stretcher offset under each piece of the top. specify 1" or 6" offset		<b>2XC</b> (2) 12"H stretchers centered under each piece of the top 6" apart	36 x 48 x 30H	1	TLLOS36048S - PV	2,060	2,320
			36 x 54 x 30H	1	TLLOS36054S - PV	2,130	2,410
			36 x 60 x 30H	1	TLLOS36060S - PV	2,210	2,500
			36 x 66 x 30H	1	TLLOS36066S - PV	2,280	2,590
			36 x 72 x 30H	1	TLLOS36072S - PV	2,460	2,790
			36 x 84 x 30H	1	TLLOS36084S - PV	2,600	2,950
			36 x 96 x 30H	1	TLLOS36096S - PV	2,680	3,050
			24 x 120 x 30H	2	TLLOS24120S - PV	3,460	3,830
			24 x 144 x 30H	2	TLLOS24144S - PV	3,650	4,050
			24 x 192 x 30H	2	TLLOS24192S - PV	4,320	4,860
			30 x 120 x 30H	2	TLLOS30120S - PV	3,860	4,260
			30 x 144 x 30H	2	TLLOS30144S - PV	4,290	4,840
30 x 192 x 30H	2	TLLOS30192S - PV	5,030	5,680			
<b>2XC</b> (2) 12"H stretchers centered under each piece of the top 6" apart		<b>2XC</b> (2) 12"H stretchers centered under each piece of the top 6" apart	36 x 120 x 30H	2	TLLOS36120S - PV	4,200	4,620
			36 x 144 x 30H	2	TLLOS36144S - PV	4,580	5,040
			36 x 192 x 30H	2	TLLOS36192S - PV	5,470	6,050
			24 x 216 x 30H	3	TLLOS24216S - PV	5,210	5,820
			24 x 240 x 30H	3	TLLOS24240S - PV	5,550	6,220
			30 x 216 x 30H	3	TLLOS30216S - PV	5,720	6,380
			30 x 240 x 30H	3	TLLOS30240S - PV	6,090	6,820
			36 x 216 x 30H	3	TLLOS36216S - PV	6,110	6,740
			36 x 240 x 30H	3	TLLOS36240S - PV	6,470	7,180

**Wire Management 3-sided Chase options:**

**Losa 3 sided laminate wire management chase with latches for 1 end panel base\***

Seated height chase (6"W x 3"D x 16.56"H) model # **OBLOSWM3SCE30-6** - \$330 list

**Losa 3 sided laminate wire management chase with latches for both end panel bases**

Seated height chase (6"W x 3"D x 16.56"H) model # **OBLOSWM3SC2E30-6** - \$660 list

**Losa 3 sided laminate wire management chase with latches for 1 middle support panel base\***

Seated height chase (6"W x 3"D x 16.56"H) model # **OBLOSWM3SCM30-6** - \$330 list

\*for tables with offset stretchers, specify which panel and the placement of the wire manager (user left or right)



**Wire Management Mouse Hole options:**

**Wire Management cut out options for end /middle panels:**

Losa wire management mouse hole (1) stretcher at the top / center - model # **OBOLOSWMHHS** - \$20 list

Losa wire management notched cut out for power supply (1) stretcher at top / center model # **OBOLOSWMNCOS** - \$60 list

Losa wire management mouse hole (1) in the end panel or middle support panel at the top / center model # **OBOLOSWMHPT** - \$20 list

Losa wire management notched cut out for power supply (1) end panel or middle support panel at top / center model # **OBOLOSWMNCOP** - \$60 list

Losa wire management mouse hole (1) in the end panel or middle support panel at the bottom / center model # **OBOLOSWMHPB** - \$20 list

Losa wire management cut out (1) on the end panel 18" at center from the bottom center of the panel model # **OBOLOSWMCOEP** - \$60 list

\*\*\*specify which panel or stretcher shall have the mouse hole or cut out on your PO

Please contact service@symphonytables.com to make sure that your power and/or wire management solution will work with the Losa table specification. We are able to modify this table with a custom solution to fit your projects needs.

Formica + Wilsonart HPL laminate finish grades listed on pages 6-13. For additional laminate grades, contact Symphony.

# tables

Losa seated height  
12"H stretchers

Losa 30"H table		dimensions	model no.	grade 1 list	grade 2 list
<b>1 piece top - (2) 12"H stretchers centered under the top stretchers 12" apart</b>		42 x 48 x 30H	TLLOS42048S2XCPV	2,110	2,380
		42 x 54 x 30H	TLLOS42054S2XCPV	2,200	2,480
		42 x 60 x 30H	TLLOS42060S2XCPV	2,270	2,570
		42 x 66 x 30H	TLLOS42066S2XCPV	2,350	2,670
		42 x 72 x 30H	TLLOS42072S2XCPV	2,530	2,870
		42 x 84 x 30H	TLLOS42084S2XCPV	2,670	3,040
		42 x 96 x 30H	TLLOS42096S2XCPV	2,820	3,220
		48 x 54 x 30H	TLLOS48054S2XCPV	2,400	2,740
		48 x 60 x 30H	TLLOS48060S2XCPV	2,490	2,850
		48 x 66 x 30H	TLLOS48066S2XCPV	2,580	2,950
		48 x 72 x 30H	TLLOS48072S2XCPV	2,780	3,170
		48 x 84 x 30H	TLLOS48084S2XCPV	2,800	3,200
48 x 96 x 30H	TLLOS48096S2XCPV	2,820	3,220		
<b>2 piece top - (2) 12"H stretchers centered under each piece of the top stretchers 12" apart</b>		54 x 60 x 30H	TLLOS54060S2XCPV	3,190	3,620
		54 x 66 x 30H	TLLOS54066S2XCPV	3,300	3,740
		54 x 72 x 30H	TLLOS54072S2XCPV	3,400	3,870
		54 x 84 x 30H	TLLOS54084S2XCPV	3,430	3,900
		54 x 96 x 30H	TLLOS54096S2XCPV	3,450	3,930
		60 x 66 x 30H	TLLOS60066S2XCPV	3,620	4,040
		60 x 72 x 30H	TLLOS60072S2XCPV	3,710	4,160
		60 x 84 x 30H	TLLOS60084S2XCPV	3,730	4,180
		60 x 96 x 30H	TLLOS60096S2XCPV	3,760	4,210
		42 x 120 x 30H	TLLOS42120S2XCPV	4,650	5,110
		42 x 144 x 30H	TLLOS42144S2XCPV	5,100	5,610
		42 x 192 x 30H	TLLOS42192S2XCPV	6,220	6,630
<b>3 piece top - (2) 12"H stretchers centered under each piece of the top stretchers 12" apart</b>		48 x 120 x 30H	TLLOS48120S2XCPV	4,650	5,110
		48 x 144 x 30H	TLLOS48144S2XCPV	5,100	5,610
		48 x 192 x 30H	TLLOS48192S2XCPV	6,270	6,920
		54 x 120 x 30H	TLLOS54120S2XCPV	5,690	6,390
		54 x 144 x 30H	TLLOS54144S2XCPV	5,950	6,700
		54 x 192 x 30H	TLLOS54192S2XCPV	6,900	7,840
		60 x 120 x 30H	TLLOS60120S2XCPV	6,080	6,370
		60 x 144 x 30H	TLLOS60144S2XCPV	6,340	6,920
		60 x 192 x 30H	TLLOS60192S2XCPV	7,290	8,060
		42 x 216 x 30H	TLLOS42216S2XCPV	6,790	7,510
		42 x 240 x 30H	TLLOS42240S2XCPV	7,180	8,000
		48 x 216 x 30H	TLLOS48216S2XCPV	6,840	7,570
48 x 240 x 30H	TLLOS48240S2XCPV	8,320	8,050		
54 x 216 x 30H	TLLOS54216S2XCPV	7,990	8,960		
54 x 240 x 30H	TLLOS54240S2XCPV	8,490	9,570		
60 x 216 x 30H	TLLOS60216S2XCPV	8,340	9,270		
60 x 240 x 30H	TLLOS60240S2XCPV	8,820	9,850		

**Wire Management 3-sided Chase options:**

**Losa 3 sided laminate wire management chase with latches for 1 end panel base**

Seated height chase (12"W x 3"D x 16.56"H) model # **OBLOSWM3SCE30-12** - \$330 list

**Losa 3 sided laminate wire management chase with latches for both end panel bases**

Seated height chase (12"W x 3"D x 16.56"H) model # **OBLOSWM3SC2E30-12** - \$660 list

**Losa 3 sided laminate wire management chase with latches for 1 middle support panel base**

Seated height chase (12"W x 3"D x 16.56"H) model # **OBLOSWM3SCM30-12** - \$330 list



**Wire Management Mouse Hole options:**

**Wire Management cut out options for end /middle panels:**

Losa wire management mouse hole (1) stretcher at the top / center - model # **OBOLOSWMHHS** - \$20 list

Losa wire management notched cut out for power supply (1) stretcher at top / center - model # **OBOLOSWMNCOS** - \$60 list

Losa wire management mouse hole (1) in the end panel or middle support panel at the top / center model # **OBOLOSWMHPT** - \$20 list

Losa wire management notched cut out for power supply (1) end panel or middle support panel at top / center model # **OBOLOSWMNCOP** - \$60 list

Losa wire management mouse hole (1) in the end panel or middle support panel at the bottom / center model # **OBOLOSWMHPB** - \$20 list

Losa wire management cut out (1) on the end panel 18" at center from the bottom center of the panel model # **OBOLOSWMCOEP** - \$60 list

\*\*\*specify which panel or stretcher shall have the mouse hole or cut out on your PO



# tables

## Losa seated height full height stretcher

For complete model number:

1. insert 2 letter stretcher option code:

**FC** - (1) full height stretcher centered under each piece of the top

**FO** - (1) full height stretcher offset under each piece of the top

*\*specify offset stretcher placement - 1" or 6" from approach edge of top*

Losa 30"H table		dimensions	1, 2 or 3 piece top	model no.	grade 1 list	grade 2 list
<b>FC</b> (1) full height stretcher centered under each piece of the top		24 x 48 x 30H	1	TLLOS24048S_PV	2,090	2,370
		24 x 54 x 30H	1	TLLOS24054S_PV	2,190	2,490
		24 x 60 x 30H	1	TLLOS24060S_PV	2,210	2,510
		24 x 66 x 30H	1	TLLOS24066S_PV	2,340	2,670
		24 x 72 x 30H	1	TLLOS24072S_PV	2,360	2,690
		24 x 84 x 30H	1	TLLOS24084S_PV	2,640	3,000
		24 x 96 x 30H	1	TLLOS24096S_PV	2,780	3,170
		30 x 48 x 30H	1	TLLOS30048S_PV	2,190	2,490
		30 x 54 x 30H	1	TLLOS30054S_PV	2,290	2,610
		30 x 60 x 30H	1	TLLOS30060S_PV	2,390	2,730
<b>FO</b> (1) full height stretcher offset under each piece of the top specify 1" or 6" offset		30 x 66 x 30H	1	TLLOS30066S_PV	2,490	2,850
		30 x 72 x 30H	1	TLLOS30072S_PV	2,510	2,880
		30 x 84 x 30H	1	TLLOS30084S_PV	2,800	3,200
		30 x 96 x 30H	1	TLLOS30096S_PV	2,940	3,370
		36 x 48 x 30H	1	TLLOS36048S_PV	2,300	2,600
		36 x 54 x 30H	1	TLLOS36054S_PV	2,410	2,730
		36 x 60 x 30H	1	TLLOS36060S_PV	2,510	2,850
		36 x 66 x 30H	1	TLLOS36066S_PV	2,610	2,960
		36 x 72 x 30H	1	TLLOS36072S_PV	2,810	3,190
		36 x 84 x 30H	1	TLLOS36084S_PV	2,990	3,410
stretcher panel 1" offset		36 x 96 x 30H	1	TLLOS36096S_PV	3,120	3,560
		24 x 120 x 30H	2	TLLOS24120S_PV	3,990	4,450
		24 x 144 x 30H	2	TLLOS24144S_PV	4,270	4,770
		24 x 192 x 30H	2	TLLOS24192S_PV	5,120	5,800
		30 x 120 x 30H	2	TLLOS30120S_PV	4,390	4,880
		30 x 144 x 30H	2	TLLOS30144S_PV	4,910	5,460
		30 x 192 x 30H	2	TLLOS30192S_PV	5,830	6,550
		36 x 120 x 30H	2	TLLOS36120S_PV	4,730	5,240
		36 x 144 x 30H	2	TLLOS36144S_PV	5,200	5,760
		36 x 192 x 30H	2	TLLOS36192S_PV	6,130	6,880
stretcher panel 6" offset		24 x 216 x 30H	3	TLLOS24216S_PV	6,100	6,860
		24 x 240 x 30H	3	TLLOS24240S_PV	6,530	7,380
		30 x 216 x 30H	3	TLLOS30216S_PV	6,610	7,430
		30 x 240 x 30H	3	TLLOS30240S_PV	7,060	7,980
		36 x 216 x 30H	3	TLLOS36216S_PV	6,930	7,760
		36 x 240 x 30H	3	TLLOS36240S_PV	7,390	8,320

### Wire Management Door option:



**Losa wire management door with finger pull for 1 full height stretcher\*\***

(door dimensions: 10.5"W x 12.5"H) model # **OBOLOSWMDD1** - \$200 list

**Losa wire management door with finger pull for 2 full height stretchers\*\***

(door dimensions: 10.5"W x 12.5"H) model # **OBOLOSWMDD2** - \$400 list

**Losa wire management door with finger pull for 3 full height stretchers\*\***

(door dimensions: 10.5"W x 12.5"H) model # **OBOLOSWMDD3** - \$600 list

*\*\*specify placement and confirm which panel shall receive the door for tables with multiple stretchers*

### Wire Management Mouse Hole options:



Losa wire management mouse hole (1) stretcher at the top / center - model # **OBOLOSWMHHS** - \$20 list



Losa wire management mouse hole (1) in the end panel or middle support panel at the top / center model # **OBOLOSWMHPT** - \$20 list



Losa wire management mouse hole (1) in the end panel or middle support panel at the bottom / center model # **OBOLOSWMHPB** - \$20 list

### Wire Management cut out options for end /middle panels:



Losa wire management notched cut out for power supply (1) stretcher at top / center model # **OBOLOSWMNCOS** - \$60 list

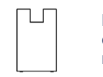

Losa wire management notched cut out for power supply (1) end panel or middle support panel at top / center model # **OBOLOSWMNCOP** - \$60 list

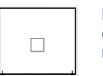

Losa wire management cut out (1) on the end panel 18" at center from the bottom center of the panel model # **OBOLOSWMCOEP** - \$60 list

*\*\*\*specify which panel or stretcher shall have the mouse hole or cut out on your PO*

Please contact [service@symphonytables.com](mailto:service@symphonytables.com) to make sure that your power and/or wire management solution will work with the Losa table specification. We are able to modify this table with a custom solution to fit your projects needs.

Formica + Wilsonart HPL laminate finish grades listed on pages 6-13. For additional laminate grades, contact Symphony.

# tables

## Losa seated height full height stretchers

Losa 30"H table		dimensions	1, 2 or 3 piece top	model no.	grade 1 list	grade 2 list
<b>(2) full height stretchers centered under each piece of the top stretchers 6" apart</b>		24 x 48 x 30H	1	TLLOS24048S2FCPV	2,350	2,660
		24 x 54 x 30H	1	TLLOS24054S2FCPV	2,470	2,810
		24 x 60 x 30H	1	TLLOS24060S2FCPV	2,520	2,860
		24 x 66 x 30H	1	TLLOS24066S2FCPV	2,670	3,040
		24 x 72 x 30H	1	TLLOS24072S2FCPV	2,710	3,090
		24 x 84 x 30H	1	TLLOS24084S2FCPV	3,030	3,460
		24 x 96 x 30H	1	TLLOS24096S2FCPV	3,220	3,680
		30 x 48 x 30H	1	TLLOS30048S2FCPV	2,450	2,780
		30 x 54 x 30H	1	TLLOS30054S2FCPV	2,580	2,940
		30 x 60 x 30H	1	TLLOS30060S2FCPV	2,700	3,080
stretcher panel 1" offset		30 x 66 x 30H	1	TLLOS30066S2FCPV	2,820	3,220
		30 x 72 x 30H	1	TLLOS30072S2FCPV	2,860	3,280
		30 x 84 x 30H	1	TLLOS30084S2FCPV	3,200	3,660
		30 x 96 x 30H	1	TLLOS30096S2FCPV	3,380	3,880
		36 x 48 x 30H	1	TLLOS36048S2FCPV	2,570	2,900
		36 x 54 x 30H	1	TLLOS36054S2FCPV	2,690	3,050
		36 x 60 x 30H	1	TLLOS36060S2FCPV	2,820	3,200
		36 x 66 x 30H	1	TLLOS36066S2FCPV	2,930	3,340
		36 x 72 x 30H	1	TLLOS36072S2FCPV	3,170	3,590
		36 x 84 x 30H	1	TLLOS36084S2FCPV	3,390	3,860
stretcher panel 6" offset		36 x 96 x 30H	1	TLLOS36096S2FCPV	3,560	4,070
		24 x 120 x 30H	2	TLLOS24120S2FCPV	4,520	5,060
		24 x 144 x 30H	2	TLLOS24144S2FCPV	4,880	5,500
		24 x 192 x 30H	2	TLLOS24192S2FCPV	5,910	6,730
		30 x 120 x 30H	2	TLLOS30120S2FCPV	4,920	5,500
		30 x 144 x 30H	2	TLLOS30144S2FCPV	5,530	6,180
		30 x 192 x 30H	2	TLLOS30192S2FCPV	6,620	7,490
		36 x 120 x 30H	2	TLLOS36120S2FCPV	5,260	5,850
		36 x 144 x 30H	2	TLLOS36144S2FCPV	5,820	6,480
		36 x 192 x 30H	2	TLLOS36192S2FCPV	6,930	7,820
stretcher panel 1" offset		24 x 216 x 30H	3	TLLOS24216S2FCPV	6,990	7,910
		24 x 240 x 30H	3	TLLOS24240S2FCPV	7,500	8,530
		30 x 216 x 30H	3	TLLOS30216S2FCPV	7,500	8,470
		30 x 240 x 30H	3	TLLOS30240S2FCPV	8,040	9,130
		36 x 216 x 30H	3	TLLOS36216S2FCPV	7,810	8,810
		36 x 240 x 30H	3	TLLOS36240S2FCPV	8,370	9,470

### Wire Management Door option:



**Losa wire management door with finger pull for 1 full height stretcher\*\***

(door dimensions: 10.5"W x 12.5"H) model # **OBOLOSWMDD1** - \$200 list

**Losa wire management door with finger pull for 2 full height stretchers\*\***

(door dimensions: 10.5"W x 12.5"H) model # **OBOLOSWMDD2** - \$400 list

**Losa wire management door with finger pull for 3 full height stretchers\*\***

(door dimensions: 10.5"W x 12.5"H) model # **OBOLOSWMDD3** - \$600 list

*\*\*specify placement and confirm which panel shall receive the door for tables with multiple stretchers*

### Wire Management Mouse Hole options:



Losa wire management mouse hole (1) stretcher at the top / center - model # **OBOLOSWMHHS** - \$20 list

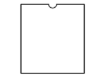

Losa wire management mouse hole (1) in the end panel or middle support panel at the top / center - model # **OBOLOSWMHPT** - \$20 list

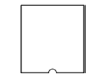

Losa wire management mouse hole (1) in the end panel or middle support panel at the bottom / center model # **OBOLOSWMHPB** - \$20 list

### Wire Management cut out options for end /middle panels:



Losa wire management notched cut out for power supply (1) stretcher at top / center model # **OBOLOSWMNCOS** - \$60 list

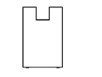

Losa wire management notched cut out for power supply (1) end panel or middle support panel at top / center model # **OBOLOSWMNCOP** - \$60 list

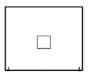

Losa wire management cut out (1) on the end panel 18" at center from the bottom center of the panel model # **OBOLOSWMCOEP** - \$60 list

*\*\*\*specify which panel or stretcher shall have the mouse hole or cut out on your PO*

Please contact [service@symphonytables.com](mailto:service@symphonytables.com) to make sure that your power and/or wire management solution will work with the Losa table specification. We are able to modify this table with a custom solution to fit your projects needs.

Formica + Wilsonart HPL laminate finish grades listed on pages 6-13. For additional laminate grades, contact Symphony.

# tables

## Losa seated height full height stretchers

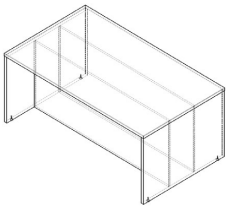
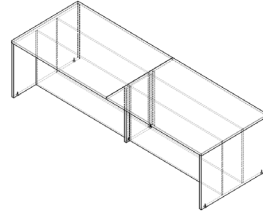
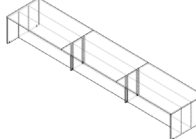
Losa 30"H table	dimensions	model no.	grade 1 list	grade 2 list	
1 piece top - (2) full height stretchers centered under the top stretchers 12" apart 	42 x 48 x 30H	TLLOS42048S2FCPV	2,620	2,970	
	42 x 54 x 30H	TLLOS42054S2FCPV	2,750	3,120	
	42 x 60 x 30H	TLLOS42060S2FCPV	2,880	3,270	
	42 x 66 x 30H	TLLOS42066S2FCPV	3,000	3,420	
	42 x 72 x 30H	TLLOS42072S2FCPV	3,240	3,680	
	42 x 84 x 30H	TLLOS42084S2FCPV	3,470	3,950	
	42 x 96 x 30H	TLLOS42096S2FCPV	3,710	4,240	
	48 x 54 x 30H	TLLOS48054S2FCPV	2,970	3,380	
	48 x 60 x 30H	TLLOS48060S2FCPV	3,110	3,550	
	48 x 66 x 30H	TLLOS48066S2FCPV	3,240	3,710	
	48 x 72 x 30H	TLLOS48072S2FCPV	3,490	3,980	
	48 x 84 x 30H	TLLOS48084S2FCPV	3,600	4,110	
	48 x 96 x 30H	TLLOS48096S2FCPV	3,710	4,240	
	54 x 60 x 30H	TLLOS54060S2FCPV	3,810	4,320	
	54 x 66 x 30H	TLLOS54066S2FCPV	3,960	4,500	
	54 x 72 x 30H	TLLOS54072S2FCPV	4,100	4,670	
	54 x 84 x 30H	TLLOS54084S2FCPV	4,220	4,810	
	54 x 96 x 30H	TLLOS54096S2FCPV	4,340	4,950	
	2 piece top - (2) full height stretchers centered under each piece of the stretchers 12" apart 	42 x 120 x 30H	TLLOS42120S2FCPV	5,710	6,350
		42 x 144 x 30H	TLLOS42144S2FCPV	6,340	7,060
42 x 192 x 30H		TLLOS42192S2FCPV	7,540	8,510	
48 x 120 x 30H		TLLOS48120S2FCPV	5,710	6,350	
48 x 144 x 30H		TLLOS48144S2FCPV	6,340	7,060	
48 x 192 x 30H		TLLOS48192S2FCPV	7,660	8,620	
54 x 120 x 30H		TLLOS54120S2FCPV	6,640	7,370	
54 x 144 x 30H		TLLOS54144S2FCPV	7,080	7,900	
54 x 192 x 30H		TLLOS54192S2FCPV	8,440	9,530	
60 x 120 x 30H		TLLOS60120S2FCPV	6,870	7,600	
60 x 144 x 30H		TLLOS60144S2FCPV	7,310	8,130	
60 x 192 x 30H		TLLOS60192S2FCPV	8,670	9,770	
3 piece top - (2) full height stretchers centered under each piece of the stretchers 12" apart 	42 x 216 x 30H	TLLOS42216S2FCPV	8,470	9,550	
	42 x 240 x 30H	TLLOS42240S2FCPV	9,080	10,280	
	48 x 216 x 30H	TLLOS48216S2FCPV	8,470	9,550	
	48 x 240 x 30H	TLLOS48240S2FCPV	9,080	10,280	
	54 x 216 x 30H	TLLOS54216S2FCPV	9,760	11,050	
	54 x 240 x 30H	TLLOS54240S2FCPV	10,440	11,870	
	60 x 216 x 30H	TLLOS60216S2FCPV	9,990	11,290	
	60 x 240 x 30H	TLLOS60240S2FCPV	10,680	12,110	

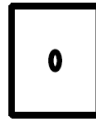

### Wire Management Door option:





**Losa wire management door with finger pull for 1 full height stretcher\*\***  
(door dimensions: 10.5"W x 12.5"H) model # **OBOLOSWM1** - \$200 list  
**Losa wire management door with finger pull for 2 full height stretchers\*\***  
(door dimensions: 10.5"W x 12.5"H) model # **OBOLOSWM2** - \$400 list  
**Losa wire management door with finger pull for 3 full height stretchers\*\***  
(door dimensions: 10.5"W x 12.5"H) model # **OBOLOSWM3** - \$600 list

\*\*specify placement and confirm which panel shall receive the door for tables with multiple stretchers

### Wire Management Mouse Hole options:

-  Losa wire management mouse hole (1) stretcher at the top / center - model # **OBOLOSWMHHS** - \$20 list
-  Losa wire management mouse hole (1) in the end panel or middle support panel at the top / center model # **OBOLOSWMHPT** - \$20 list
-  Losa wire management mouse hole (1) in the end panel or middle support panel at the bottom / center model # **OBOLOSWMHPB** - \$20 list

### Wire Management cut out options for end /middle panels:

-  Losa wire management notched cut out for power supply (1) stretcher at top / center model # **OBOLOSWMNCOS** - \$60 list
-  Losa wire management notched cut out for power supply (1) end panel or middle support panel at top / center - model # **OBOLOSWMNCOP** - \$60 list
-  Losa wire management cut out (1) on the end panel 18" at center from the bottom center of the panel model # **OBOLOSWMCOEP** - \$60 list

\*\*\*specify which panel or stretcher shall have the mouse hole or cut out on your PO

Please contact [service@symphonytables.com](mailto:service@symphonytables.com) to make sure that your power and/or wire management solution will work with the Losa table specification. We are able to modify this table with a custom solution to fit your projects needs.

Formica + Wilsonart HPL laminate finish grades listed on pages 6-13. For additional laminate grades, contact Symphony.

# tables

## Losa counter and bar height 12"H stretcher(s)

For complete model number:  
1. insert 1 letter height code:  
**C** - 36" counter height  
**B** - 42" bar height

2. insert 2 letter stretcher option code:  
**XC** - (1) 12" high stretcher centered under each piece of the top  
**XO** - (1) 12" high stretcher offset under each piece of the top  
*\*specify offset stretcher placement - 1" or 6" from approach edge of top*  
**2XC** - (2) 12" high stretchers centered under each piece of the top  
stretchers come standard 6" apart for tops that are 24", 30" or 36" deep

Losa table			dimensions	1, 2 or 3 piece top	model no.	grade 1 list	grade 2 list
<b>XC</b> (1) 12"H stretcher centered under each piece of the top		stretcher panel 1" offset	24 x 48	1	TLLOS24048_PV	1,950	2,210
			24 x 54	1	TLLOS24054_PV	2,030	2,310
			24 x 60	1	TLLOS24060_PV	2,030	2,310
			24 x 66	1	TLLOS24066_PV	2,140	2,450
			24 x 72	1	TLLOS24072_PV	2,140	2,450
			24 x 84	1	TLLOS24084_PV	2,380	2,720
			24 x 96	1	TLLOS24096_PV	2,500	2,860
			30 x 48	1	TLLOS30048_PV	2,110	2,410
			30 x 54	1	TLLOS30054_PV	2,200	2,520
			30 x 60	1	TLLOS30060_PV	2,200	2,520
			30 x 66	1	TLLOS30066_PV	2,320	2,660
			30 x 72	1	TLLOS30072_PV	2,320	2,660
30 x 84	1	TLLOS30084_PV	2,580	2,950			
30 x 96	1	TLLOS30096_PV	2,680	3,070			
<b>XO</b> (1) 12"H stretcher offset under each piece of the top. specify 1" or 6" offset		stretcher panel 1" offset	36 x 48	1	TLLOS36048_PV	2,170	2,460
			36 x 54	1	TLLOS36054_PV	2,260	2,570
			36 x 60	1	TLLOS36060_PV	2,350	2,670
			36 x 66	1	TLLOS36066_PV	2,430	2,770
			36 x 72	1	TLLOS36072_PV	2,620	2,980
			36 x 84	1	TLLOS36084_PV	2,770	3,160
		stretcher panel 6" offset	36 x 96	1	TLLOS36096_PV	2,870	3,270
			24 x 120	2	TLLOS24120_PV	3,650	4,050
			24 x 144	2	TLLOS24144_PV	3,850	4,300
			24 x 192	2	TLLOS24192_PV	4,590	5,190
			30 x 120	2	TLLOS30120_PV	4,060	4,500
			30 x 144	2	TLLOS30144_PV	4,520	5,000
30 x 192	2	TLLOS30192_PV	5,320	5,970			
36 x 120	2	TLLOS36120_PV	4,410	4,870			
36 x 144	2	TLLOS36144_PV	4,810	5,310			
36 x 192	2	TLLOS36192_PV	5,640	6,310			
24 x 216	3	TLLOS24216_PV	5,520	6,190			
24 x 240	3	TLLOS24240_PV	5,890	6,640			
30 x 216	3	TLLOS30216_PV	6,050	6,780			
30 x 240	3	TLLOS30240_PV	6,460	7,270			
36 x 216	3	TLLOS36216_PV	6,380	7,130			
36 x 240	3	TLLOS36240_PV	6,800	7,630			

### Wire Management 3-sided Chase options:

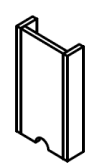

#### Losa 3 sided laminate wire management chase with latches for 1 end panel base\*

Counter height chase (22.56"H) model # **OBLOSWM3SCE36-6** - \$350 list  
Bar height chase (28.56"H) model # **OBLOSWM3SCE42-6** - \$370 list

#### Losa 3 sided laminate wire management chase with latches for both end panel bases

Counter height chase (22.56"H) model # **OBLOSWM3SC2E36-6** - \$700 list  
Bar height chase (28.56"H) model # **OBLOSWM3SC2E42-6** - \$740 list

#### Losa 3 sided laminate wire management chase with latches for 1 middle panel base\*

Counter height chase (22.56"H) model # **OBLOSWM3SCM36-6** - \$350 list  
Bar height chase (28.56"H) model # **OBLOSWM3SCM42-6** - \$370 list

\*for tables with offset stretchers, specify which panel and the placement of the wire manager (user left or right)

### Wire Management Mouse Hole options:

Losa wire management mouse hole (1) stretcher at the top / center - model # **OBOLOSWMHHS** - \$20 list

Losa wire management mouse hole (1) in the end panel or middle support panel at the top / center - model # **OBOLOSWMHPT** - \$20 list

Losa wire management mouse hole (1) in the end panel or middle support panel at the bottom / center - model # **OBOLOSWMHPB** - \$20 list

### Wire Management cut out options for end /middle panels:

Losa wire management notched cut out for power supply (1) stretcher at top / center - model # **OBOLOSWMNCOS** - \$60 list

Losa wire management notched cut out for power supply (1) end panel or middle support panel at top / center - model # **OBOLOSWMNCOP** - \$60 list

Losa wire management cut out (1) on the end panel 18" at center from the bottom center of the panel - model # **OBOLOSWMCOEP** - \$60 list

\*\*\*Specify which panel or stretcher shall have the mouse hole or cut out on your PO

Please contact [service@symphonytables.com](mailto:service@symphonytables.com) to make sure that your power and/or wire management solution will work with the Losa table specification. We are able to modify this table with a custom solution to fit your projects needs.

# tables

## Losa counter and bar height 12"H stretchers

For complete model number - insert 1 letter height code:  
**C** - 36" counter height  
**B** - 42" bar height

Formica + Wilsonart HPL laminate finish grades listed on pages 6-13. For additional laminate grades, contact Symphony.

Losa table - stretchers 12" apart		dimensions	model no.	grade 1 list	grade 2 list
<b>1 piece top - (2) 12"H stretchers centered under the top</b>		42 x 48	TLLOS42048_2XCPV	2,230	2,540
		42 x 54	TLLOS42054_2XCPV	2,330	2,650
		42 x 60	TLLOS42060_2XCPV	2,420	2,760
		42 x 66	TLLOS42066_2XCPV	2,500	2,860
		42 x 72	TLLOS42072_2XCPV	2,700	3,070
		42 x 84	TLLOS42084_2XCPV	2,860	3,260
		42 x 96	TLLOS42096_2XCPV	3,030	3,460
		48 x 54	TLLOS48054_2XCPV	2,330	2,650
		48 x 60	TLLOS48060_2XCPV	2,420	2,760
		48 x 66	TLLOS48066_2XCPV	2,500	2,860
		48 x 72	TLLOS48072_2XCPV	2,700	3,070
		48 x 84	TLLOS48084_2XCPV	2,720	3,100
48 x 96	TLLOS48096_2XCPV	3,030	3,460		
<b>2 piece top - (2) 12"H stretchers centered under each piece of the top</b>		54 x 60	TLLOS54060_2XCPV	3,400	3,870
		54 x 66	TLLOS54066_2XCPV	3,520	4,010
		54 x 72	TLLOS54072_2XCPV	3,630	4,150
		54 x 84	TLLOS54084_2XCPV	3,660	4,180
		54 x 96	TLLOS54096_2XCPV	3,690	4,220
		60 x 66	TLLOS60066_2XCPV	3,750	4,240
		60 x 72	TLLOS60072_2XCPV	3,870	4,380
		60 x 84	TLLOS60084_2XCPV	3,890	4,410
		60 x 96	TLLOS60096_2XCPV	3,930	4,450
		42 x 120	TLLOS42120_2XCPV	4,880	5,390
		42 x 144	TLLOS42144_2XCPV	5,350	5,910
		42 x 192	TLLOS42192_2XCPV	6,280	7,030
48 x 120	TLLOS48120_2XCPV	4,880	5,390		
48 x 144	TLLOS48144_2XCPV	5,350	5,910		
48 x 192	TLLOS48192_2XCPV	6,400	7,140		
54 x 120	TLLOS54120_2XCPV	5,850	6,470		
54 x 144	TLLOS54144_2XCPV	6,150	6,820		
54 x 192	TLLOS54192_2XCPV	7,250	8,140		
60 x 120	TLLOS60120_2XCPV	6,090	6,700		
60 x 144	TLLOS60144_2XCPV	6,380	7,050		
60 x 192	TLLOS60192_2XCPV	7,480	8,380		
<b>3 piece top - (2) 12"H stretchers centered under each piece of the top</b>		42 x 216	TLLOS42216_2XCPV	7,070	7,910
		42 x 240	TLLOS42240_2XCPV	7,540	8,470
		48 x 216	TLLOS48216_2XCPV	7,070	7,910
		48 x 240	TLLOS48240_2XCPV	7,540	8,470
		54 x 216	TLLOS54216_2XCPV	8,470	9,550
		54 x 240	TLLOS54240_2XCPV	9,030	10,210
		60 x 216	TLLOS60216_2XCPV	8,710	9,780
		60 x 240	TLLOS60240_2XCPV	9,260	10,440

### Wire Management 3-sided Chase options:

#### Losa 3 sided laminate wire management chase with latches for 1 end panel base

Counter height chase (22.56"H) model # **OBLOSWM3SCE36-12** - \$350 list  
Bar height chase (28.56"H) model # **OBLOSWM3SCE42-12** - \$370 list

#### Losa 3 sided laminate wire management chase with latches for both end panel bases

Counter height chase (22.56"H) model # **OBLOSWM3SC2E36-12** - \$700 list  
Bar height chase (28.56"H) model # **OBLOSWM3SC2E42-12** - \$740 list

#### Losa 3 sided laminate wire management chase with latches for 1 middle panel base

Counter height chase (22.56"H) model # **OBLOSWM3SCM36-12** - \$350 list  
Bar height chase (28.56"H) model # **OBLOSWM3SCM42-12** - \$370 list

### Wire Management Mouse Hole options:

Losa wire management mouse hole (1) stretcher at the top / center - model # **OBOLOSWMHHS** - \$20 list

Losa wire management mouse hole (1) in the end panel or middle support panel at the top / center - model # **OBOLOSWMHPT** - \$20 list

Losa wire management mouse hole (1) in the end panel or middle support panel at the bottom / center - model # **OBOLOSWMHPB** - \$20 list

### Wire Management cut out options for end /middle panels:

Losa wire management notched cut out for power supply (1) stretcher at top / center - model # **OBOLOSWMNCOS** - \$60 list

Losa wire management notched cut out for power supply (1) end panel or middle support panel at top / center - model # **OBOLOSWMNCOP** - \$60 list

Losa wire management cut out (1) on the end panel 18" at center from the bottom center of the panel - model # **OBOLOSWMCOEP** - \$60 list

# tables

## Losa counter and bar height full height stretcher

For complete model number:

1. insert 1 letter height code:  
**C** - 36" counter height  
**B** - 42" bar height

2. insert 2 letter stretcher option code:

- FC** - (1) full height stretcher centered under each piece of the top  
**FO** - (1) full height stretcher offset under each piece of the top  
*\*specify offset stretcher placement - 1" or 6" from approach edge of top*

Losa table	dimensions	1, 2 or 3 piece top	model no.	grade 1 list	grade 2 list
<b>FC</b> (1) full height stretcher centered under each piece of the top	24 x 48	1	TLLOS24048_PV	2,210	2,510
	24 x 54	1	TLLOS24054_PV	2,310	2,640
	24 x 60	1	TLLOS24060_PV	2,340	2,660
	24 x 66	1	TLLOS24066_PV	2,470	2,820
	24 x 72	1	TLLOS24072_PV	2,490	2,850
	24 x 84	1	TLLOS24084_PV	2,780	3,170
	24 x 96	1	TLLOS24096_PV	2,940	3,370
	30 x 48	1	TLLOS30048_PV	2,370	2,710
	30 x 54	1	TLLOS30054_PV	2,490	2,850
	30 x 60	1	TLLOS30060_PV	2,510	2,870
	30 x 66	1	TLLOS30066_PV	2,650	3,040
	<b>FO</b> (1) full height stretcher offset under each piece of the top specify 1" or 6" offset	24 x 48	1	TLLOS24048_PV	2,430
24 x 54		1	TLLOS24054_PV	2,550	2,890
24 x 60		1	TLLOS24060_PV	2,650	3,020
24 x 66		1	TLLOS24066_PV	2,760	3,150
24 x 72		1	TLLOS24072_PV	2,970	3,380
24 x 84		1	TLLOS24084_PV	3,170	3,620
24 x 96		1	TLLOS24096_PV	3,310	3,780
30 x 48		1	TLLOS30048_PV	4,180	4,670
30 x 54		1	TLLOS30054_PV	4,470	5,020
30 x 60		1	TLLOS30060_PV	5,390	6,130
30 x 66		1	TLLOS30066_PV	6,120	6,910
modesty panel 1" offset		24 x 120	2	TLLOS24120_PV	4,180
	24 x 144	2	TLLOS24144_PV	4,470	5,020
	24 x 192	2	TLLOS24192_PV	5,390	6,130
	30 x 120	2	TLLOS30120_PV	4,590	5,120
	30 x 144	2	TLLOS30144_PV	5,140	5,730
	30 x 192	2	TLLOS30192_PV	6,120	6,910
	36 x 120	2	TLLOS36120_PV	4,940	5,490
	36 x 144	2	TLLOS36144_PV	5,430	6,040
	36 x 192	2	TLLOS36192_PV	6,440	7,250
	24 x 216	3	TLLOS24216_PV	6,410	7,240
	24 x 240	3	TLLOS24240_PV	6,870	7,790
	30 x 216	3	TLLOS30216_PV	6,940	7,830
30 x 240	3	TLLOS30240_PV	7,430	8,420	
36 x 216	3	TLLOS36216_PV	7,270	8,180	
36 x 240	3	TLLOS36240_PV	7,770	8,780	
modesty panel 6" offset					

### Wire Management Door option:



- Losa wire management door with finger pull for 1 full height stretcher\*\* (door dimensions: 10.5"W x 12.5"H) model # **OBOLOSWMDD1** - \$200 list
- Losa wire management door with finger pull for 2 full height stretchers\*\* (door dimensions: 10.5"W x 12.5"H) model # **OBOLOSWMDD2** - \$400 list
- Losa wire management door with finger pull for 3 full height stretchers\*\* (door dimensions: 10.5"W x 12.5"H) model # **OBOLOSWMDD3** - \$600 list

\*\*specify placement and confirm which panel shall receive the door for tables with multiple stretchers

### Wire Management Mouse Hole options:

- Losa wire management mouse hole (1) stretcher at the top / center - model # **OBOLOSWMHHS** - \$20 list
- Losa wire management mouse hole (1) in the end panel or middle support panel at the top / center - model # **OBOLOSWMHPT** - \$20 list
- Losa wire management mouse hole (1) in the end panel or middle support panel at the bottom / center - model # **OBOLOSWMHPB** - \$20 list

### Wire Management cut out options for end /middle

- Losa wire management notched cut out for power supply (1) stretcher at top / center model # **OBOLOSWMNCOS** - \$60 list
- Losa wire management notched cut out for power supply (1) end panel or middle support panel at top / center model # **OBOLOSWMNCOP** - \$60 list
- Losa wire management cut out (1) on the end panel 18" at center from the bottom center of the panel model # **OBOLOSWMCOEP** - \$60 list

\*\*\*specify which panel or stretcher shall have the mouse hole or cut out on your PO

Please contact service@symphonytables.com to make sure that your power and/or wire management solution will work with the Losa table specification. We are able to modify this table with a custom solution to fit your projects needs.

Formica + Wilsonart HPL laminate finish grades listed on pages 6-13. For additional laminate grades, contact Symphony.

# tables

## Losa counter and bar height full height stretchers

For complete model number - insert 1 letter height code:

- C** - 36" counter height  
**B** - 42" bar height

Losa table - stretchers 12" apart	dimensions	model no.	grade 1 list	grade 2 list
1 piece top - (2) full height stretchers centered under the top stretchers 12" apart	24 x 48	TLLOS24048_2FCPV	2,470	2,810
	24 x 54	TLLOS24054_2FCPV	2,600	2,960
	24 x 60	TLLOS24060_2FCPV	2,640	3,010
	24 x 66	TLLOS24066_2FCPV	2,800	3,200
	24 x 72	TLLOS24072_2FCPV	2,840	3,250
	24 x 84	TLLOS24084_2FCPV	3,180	3,630
	24 x 96	TLLOS24096_2FCPV	3,380	3,880
	30 x 48	TLLOS30048_2FCPV	2,630	3,000
	30 x 54	TLLOS30054_2FCPV	2,770	3,170
	30 x 60	TLLOS30060_2FCPV	2,820	3,220
	30 x 66	TLLOS30066_2FCPV	2,980	3,420
	2 piece top - (2) full height stretchers centered under each piece of the stretchers 12" apart	24 x 48	TLLOS24048_2FCPV	2,700
24 x 54		TLLOS24054_2FCPV	2,830	3,220
24 x 60		TLLOS24060_2FCPV	2,960	3,370
24 x 66		TLLOS24066_2FCPV	3,090	3,520
24 x 72		TLLOS24072_2FCPV	3,330	3,790
24 x 84		TLLOS24084_2FCPV	3,560	4,070
24 x 96		TLLOS24096_2FCPV	3,750	4,290
30 x 120		TLLOS30120_2FCPV	5,120	5,740
30 x 144		TLLOS30144_2FCPV	5,750	6,450
30 x 192		TLLOS30192_2FCPV	6,920	7,850
36 x 120		TLLOS36120_2FCPV	5,470	6,100
36 x 144		TLLOS36144_2FCPV	6,050	6,760
36 x 192	TLLOS36192_2FCPV	7,240	8,180	
3 piece top - (2) full height stretchers centered under each piece of the stretchers 12" apart	24 x 216	TLLOS24216_2FCPV	7,300	8,280
	24 x 240	TLLOS24240_2FCPV	7,850	8,940
	30 x 216	TLLOS30216_2FCPV	7,830	8,870
	30 x 240	TLLOS30240_2FCPV	8,410	9,570
	36 x 216	TLLOS36216_2FCPV	8,160	9,220
	36 x 240	TLLOS36240_2FCPV	8,750	9,930

### Wire Management Door option:



- Losa wire management door with finger pull for 1 full height stretcher\*\* (door dimensions: 10.5"W x 12.5"H) model # **OBOLOSWMDD1** - \$200 list
- Losa wire management door with finger pull for 2 full height stretchers\*\* (door dimensions: 10.5"W x 12.5"H) model # **OBOLOSWMDD2** - \$400 list
- Losa wire management door with finger pull for 3 full height stretchers\*\* (door dimensions: 10.5"W x 12.5"H) model # **OBOLOSWMDD3** - \$600 list

\*\*specify placement and confirm which panel shall receive the door for tables with multiple stretchers

### Wire Management Mouse Hole options:

- Losa wire management mouse hole (1) stretcher at the top / center - model # **OBOLOSWMHHS** - \$20 list
- Losa wire management mouse hole (1) in the end panel or middle support panel at the top / center - model # **OBOLOSWMHPT** - \$20 list
- Losa wire management mouse hole (1) in the end panel or middle support panel at the bottom / center - model # **OBOLOSWMHPB** - \$20 list

### Wire Management cut out options for end /middle panels:

- Losa wire management notched cut out for power supply (1) stretcher at top / center model # **OBOLOSWMNCOS** - \$60 list
- Losa wire management notched cut out for power supply (1) end panel or middle support panel at top / center model # **OBOLOSWMNCOP** - \$60 list
- Losa wire management cut out (1) on the end panel 18" at center from the bottom center of the panel model # **OBOLOSWMCOEP** - \$60 list

\*\*\*specify which panel or stretcher shall have the mouse hole or cut out on your PO

Please contact service@symphonytables.com to make sure that your power and/or wire management solution will work with the Losa table specification. We are able to modify this table with a custom solution to fit your projects needs.

Formica + Wilsonart HPL laminate finish grades listed on pages 6-13. For additional laminate grades, contact Symphony.

# tables

## Losa counter and bar height full height stretchers

For complete model number - insert 1 letter height code:  
**C** - 36" counter height  
**B** - 42" bar height

Formica + Wilsonart HPL laminate finish grades listed on pages 6-13. For additional laminate grades, contact Symphony.

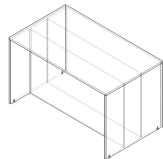
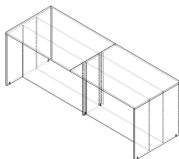
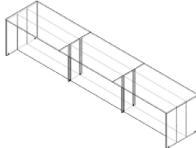
Losa table - stretchers 12" apart	dimensions	model no.	grade 1 list	grade 2 list	
1 piece top - (2) full height stretchers centered under the top 	42 x 48	TLLOS42048 _ 2FCPV	2,760	3,130	
	42 x 54	TLLOS42054 _ 2FCPV	2,900	3,290	
	42 x 60	TLLOS42060 _ 2FCPV	3,030	3,460	
	42 x 66	TLLOS42066 _ 2FCPV	3,160	3,610	
	42 x 72	TLLOS42072 _ 2FCPV	3,400	3,880	
	42 x 84	TLLOS42084 _ 2FCPV	3,650	4,170	
	42 x 96	TLLOS42096 _ 2FCPV	3,910	4,480	
	48 x 54	TLLOS48054 _ 2FCPV	2,900	3,290	
	48 x 60	TLLOS48060 _ 2FCPV	3,030	3,460	
	48 x 66	TLLOS48066 _ 2FCPV	3,160	3,610	
	48 x 72	TLLOS48072 _ 2FCPV	3,400	3,880	
	48 x 84	TLLOS48084 _ 2FCPV	3,510	4,010	
	48 x 96	TLLOS48096 _ 2FCPV	3,910	4,480	
	54 x 60	TLLOS54060 _ 2FCPV	4,020	4,570	
	54 x 66	TLLOS54066 _ 2FCPV	4,180	4,760	
	54 x 72	TLLOS54072 _ 2FCPV	4,340	4,950	
	54 x 84	TLLOS54084 _ 2FCPV	4,450	5,090	
	54 x 96	TLLOS54096 _ 2FCPV	4,570	5,240	
2 piece top - (2) full height stretchers centered under each piece of the 	42 x 120	TLLOS42120 _ 2FCPV	5,940	6,620	
	42 x 144	TLLOS42144 _ 2FCPV	6,590	7,360	
	42 x 192	TLLOS42192 _ 2FCPV	7,880	8,910	
	48 x 120	TLLOS48120 _ 2FCPV	5,940	6,620	
	48 x 144	TLLOS48144 _ 2FCPV	6,590	7,360	
	48 x 192	TLLOS48192 _ 2FCPV	7,990	9,020	
	54 x 120	TLLOS54120 _ 2FCPV	6,910	7,700	
	54 x 144	TLLOS54144 _ 2FCPV	7,390	8,270	
	54 x 192	TLLOS54192 _ 2FCPV	8,850	10,020	
	60 x 120	TLLOS60120 _ 2FCPV	7,150	7,930	
	60 x 144	TLLOS60144 _ 2FCPV	7,620	8,500	
	60 x 192	TLLOS60192 _ 2FCPV	9,080	10,250	
	3 piece top - (2) full height stretchers centered under each piece of the 	42 x 216	TLLOS42216 _ 2FCPV	8,850	10,000
		42 x 240	TLLOS42240 _ 2FCPV	9,490	10,780
		48 x 216	TLLOS48216 _ 2FCPV	8,850	10,000
		48 x 240	TLLOS48240 _ 2FCPV	9,490	10,780
		54 x 216	TLLOS54216 _ 2FCPV	10,250	11,640
		54 x 240	TLLOS54240 _ 2FCPV	10,980	12,520
60 x 216		TLLOS60216 _ 2FCPV	10,480	11,870	
60 x 240		TLLOS60240 _ 2FCPV	11,210	12,750	



### Wire Management Door option:



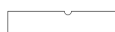

**Losa wire management door with finger pull for 1 full height stretcher\*\***  
 (door dimensions: 10.5"W x 12.5"H) model # **OBOLOSWMDD1** - \$200 list  
**Losa wire management door with finger pull for 2 full height stretchers\*\***  
 (door dimensions: 10.5"W x 12.5"H) model # **OBOLOSWMDD2** - \$400 list  
**Losa wire management door with finger pull for 3 full height stretchers\*\***  
 (door dimensions: 10.5"W x 12.5"H) model # **OBOLOSWMDD3** - \$600 list

\*\*specify placement and confirm which panel shall receive the door for tables with multiple stretchers

### Wire Management Mouse Hole options:

-  Losa wire management mouse hole (1) stretcher at the top / center - model # **OBOLOSWMHHS** - \$20 list
-  Losa wire management mouse hole (1) in the end panel or middle support panel at the top / center - model # **OBOLOSWMHPT** - \$20 list
-  Losa wire management mouse hole (1) in the end panel or middle support panel at the bottom / center - model # **OBOLOSWMHPB** - \$20 list

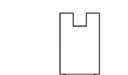
### Wire Management cut out options for end /middle panels:

-  Losa wire management notched cut out for power supply (1) stretcher at top / center model # **OBOLOSWMNCOS** - \$60 list
-  Losa wire management notched cut out for power supply (1) end panel or middle support panel at top / center model # **OBOLOSWMNCOP** - \$60 list
-  Losa wire management cut out (1) on the end panel 18" at center from the bottom center of the panel model # **OBOLOSWMCOEP** - \$60 list

\*specify which panel or stretcher shall have the mouse hole or cut out on your PO

Please contact [service@symphonytables.com](mailto:service@symphonytables.com) to make sure that your power and/or wire management solution will work with the Losa table specification. We are able to modify this table with a custom solution to fit your projects needs.

# tables

## Sala occasional

For complete model number:

1. insert base code:



**S** = no plinth base

**P** = 3/4" plinth base

2. insert laminate grade code:

**1** = grade 1 laminate

**2** = grade 2 laminate

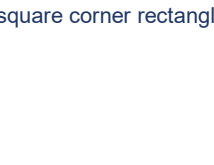
shape	dimension	height	model no.	S = no plinth base		P = 3/4" plinth				
				grade 1	grade 2	grade 1	grade 2			
	18	15	TLSAL180015	—	G	—	1,070	1,290	1,310	1,520
	24	15	TLSAL240015	—	G	—	1,230	1,480	1,470	1,720
	30	15	TLSAL300015	—	G	—	1,530	1,850	1,810	2,120
	36	15	TLSAL360015	—	G	—	1,760	2,130	2,070	2,420
	18	20	TLSAL180020	—	G	—	1,120	1,350	1,350	1,580
	24	20	TLSAL240020	—	G	—	1,320	1,590	1,560	1,820
	30	20	TLSAL300020	—	G	—	1,610	1,950	1,890	2,210
	36	20	TLSAL360020	—	G	—	1,880	2,280	2,190	2,570
	18	24	TLSAL180024	—	G	—	1,150	1,380	1,380	1,610
	24	24	TLSAL240024	—	G	—	1,390	1,670	1,630	1,910
	30	24	TLSAL300024	—	G	—	1,660	2,020	1,940	2,280
	36	24	TLSAL360024	—	G	—	2,010	2,450	2,320	2,720
	20x36	15	TLSAL203615	—	G	—	2,160	2,600	2,430	2,940
	22x40	15	TLSAL224015	—	G	—	2,430	2,930	2,730	3,310
	24x46	15	TLSAL244615	—	G	—	2,660	3,220	2,990	3,630
	20x36	20	TLSAL203620	—	G	—	2,260	2,730	2,530	3,070
	22x40	20	TLSAL224020	—	G	—	2,530	3,060	2,840	3,450
	24x46	20	TLSAL244620	—	G	—	2,780	3,360	3,110	3,770
	20x36	24	TLSAL203624	—	G	—	2,370	2,870	2,640	3,200
	22x40	24	TLSAL224024	—	G	—	2,670	3,230	2,980	3,620
24x46	24	TLSAL244624	—	G	—	2,880	3,490	3,210	3,910	
	18x18	15	TLSAL181815	—	G	—	1,450	1,760	1,680	2,050
	24x24	15	TLSAL242415	—	G	—	1,690	2,060	1,940	2,370
	30x30	15	TLSAL303015	—	G	—	1,980	2,410	2,250	2,750
	36x36	15	TLSAL363615	—	G	—	2,280	2,780	2,590	3,170
	18x18	20	TLSAL181820	—	G	—	1,520	1,850	1,750	2,130
	24x24	20	TLSAL242420	—	G	—	1,780	2,160	2,030	2,480
	30x30	20	TLSAL303020	—	G	—	2,140	2,620	2,420	2,960
	36x36	20	TLSAL363620	—	G	—	2,460	3,010	2,770	3,390
	18x18	24	TLSAL181824	—	G	—	1,560	1,900	1,790	2,190
	24x24	24	TLSAL242424	—	G	—	1,870	2,280	2,130	2,600
	30x30	24	TLSAL303024	—	G	—	2,240	2,740	2,520	3,080
	36x36	24	TLSAL363624	—	G	—	2,660	3,260	2,980	3,650
	24x30	15	TLSAL243015	—	G	—	1,800	2,200	2,080	2,550
	24x48	15	TLSAL244815	—	G	—	2,010	2,460	2,330	2,850
	24x30	20	TLSAL243020	—	G	—	1,970	2,410	2,240	2,750
	24x48	20	TLSAL244820	—	G	—	2,320	2,840	2,630	3,230
	24x30	24	TLSAL243024	—	G	—	2,160	2,640	2,430	2,990
	24x48	24	TLSAL244824	—	G	—	2,560	3,140	2,870	3,530

Formica + Wilsonart HPL laminate finish grades listed on pages 6-13. For additional laminate grades, contact Symphony.

Sala bases feature a non-adjustable plastic tack glide.

# surfaces

# surfaces

## surface overview

### Standard particleboard

The standard core consists of 1 .125" thick, 45 lb. industrial grade western particleboard. This meets or exceeds requirements of ANSA A 208 1979, 1-M-3 and is TECO tested per ASTM D-1037. The core is laminated with a .040" thick high pressure laminate top, while the underside has a .035" Polybak Ultra backing sheet applied.

### High Pressure Laminate (HPL) surface

Symphony produces tops with virtually any laminate. Most Formica and Wilsonart laminates are grade A, B, or C (see listings). However, some Formica and Wilsonart laminates plus laminates from other suppliers can exceed grade C pricing plus have extended lead times. To verify pricing and lead-times, please email [service@symphonytables.com](mailto:service@symphonytables.com) for assistance.

### To check availability or to order any samples please contact the laminate companies directly.

<a href="http://www.Formica.com">www.Formica.com</a>	800-FORMICA
<a href="http://www.Nevamar.com">www.Nevamar.com</a>	800-638-4380
<a href="http://www.Wilsonart.com">www.Wilsonart.com</a>	800-433-3222
<a href="http://www.Pionite.com">www.Pionite.com</a>	800-746-6483

# surfaces

## edge profile overview



**PVEA** eased edge band is banded with 3mm extruded synthetic PVC molding. The molding at top and bottom edges feature a slight radius, adding comfort. The 90 degree corners create a seamless table to table fit. Dimensions: 1.19" high x .0125" deep.

**PVRC** eased edge band is banded with 3mm extruded synthetic PVC molding. The molding at top and bottom edges feature a slight radius, adding comfort. 3" radius corners. Dimensions: 1.19" high x 0.125" deep.



**PVKN** edge is banded with .462 high rigid 3mm extruded synthetic PVC molding. The top edge molding features a slight radius, adding comfort. The bottom of the edge features exposed MDF core sanded smooth with a wax coating, the slanted edge has a 20 degree angle. The 90 degree corners create a seamless table to table fit. Dimensions: 1.19" high x .2" deep.

**PVKR** edge is banded with .462 high rigid 3mm extruded synthetic PVC molding. The top edge molding features a slight radius, adding comfort. The bottom of the edge features exposed MDF core sanded smooth with a wax coating, the slanted edge has a 20 degree angle. 3 inch radius corners. Dimensions: 1.19", high x .2" deep

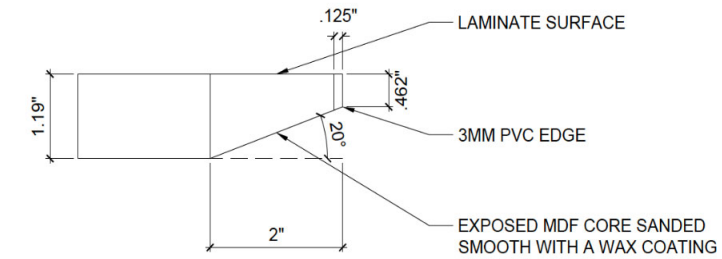

### PVC edge finishes to match Wilsonart laminates:

Alabaster, Amber Cherry, Antique White, Asian Night, Asian Sand, Atlantis, Bannister Oak, Beigewood, Biltmore Cherry, Black, Blond Echo, Brazilwood, Brighton Walnut, Cafelle, Cocobala, Coffee Bean, Columbian Walnut, Designer White, Dove Grey, Ebony Recon, Empire Mahogany, Field Elm, Figured Mahogany, Fonthill Pear, Frosty White, Fusion Maple, Graphite Nebula, Grey, Grey Elm, Grey Mesh, Hampton Walnut, Harvest Maple, High Line, Huntington Maple, Kensington Maple, Khaki Brown, Limber Maple, Linen, Manitoba Maple, Montana Walnut, Monticello Maple, Natural Almond, Nepal Teak, North Sea, Pebble, Pepperdust, Pinnacle Walnut, Platinum, River Cherry, Satin Stainless, Shadow, Skyline Walnut, Slate Grey, Solar Oak, Studio Teak, Tan Echo, Wallaby, Walnut Heights, White, Wild Cherry, Williamsburg Cherry, Windsor Mahogany, Zanzibar.



### PVC edge finishes to match Formica laminates:

Almond, Amber Maple, Antique White, Black, Bleached Legno, Brite White, Dover White, Fog, Folkstone, Graphite, Graystone, Hard Rock Maple, Natural Maple, Neutral Twill, Platinum, Prestige Walnut, Pumice, Select Cherry, Stone Grafix, Storm, White

**\*Note that this list is subject to change at any time depending on the availability of the edge from the top plant or the edge manufacturer.**

# surfaces

shapes, dimensions, weight, seating capacity

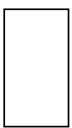
shape	A x B	seats	approximate weight (lbs)
round (RD) 	24 dia.	2	18
	30 dia.	2	28
	36 dia.	3	41
	42 dia.	4	55
	48 dia.	4-5	72
	60 dia.	6-7	113
square (SQ) 	24 x 24	2	18
	30 x 30	2	28
	36 x 36	4	42
	42 x 42	4	55
	48 x 48	4	72
	60 x 60	6-8	113
rectangle (RE) 	18 x 48	1	27
	* 18 x 60	2	34
	* 18 x 72	2	41
	* 18 x 84	2-3	48
	* 18 x 90	3	51
	* 18 x 96	3	54
	24 x 30	1	23
	24 x 36	1	27
	24 x 42	1	32
	24 x 48	1	36
	* 24 x 60	2	45
	* 24 x 66	2	50
	* 24 x 72	2	54
	* 24 x 84	2-3	63
	* 24 x 90	3	68
	* 24 x 96	3	72
	30 x 36	2	34
	30 x 42	2	40
	30 x 48	2-4	45
	** 30 x 60	4	57
	** 30 x 66	4-6	62
	** 30 x 72	6	68
	** 30 x 84	2-3	79
	** 30 x 90	3	85
** 30 x 96	3	90	
36 x 42	2	48	
36 x 48	2-4	54	
** 36 x 60	4-6	68	
** 36 x 72	6-8	81	
** 36 x 84	6-8	95	
** 36 x 90	6-8	102	
** 36 x 96	8-10	108	
2+ 36 x 120	8-10	135	
** 42 x 60	6	79	
** 42 x 72	6-8	95	
** 42 x 84	6-8	111	
** 42 x 96	8-10	126	
2+ 42 x 120	8-10	158	
2+ 42 x 144	10	190	
** 48 x 72	6	108	
** 48 x 84	6-8	126	
** 48 x 96	8-10	144	
2+ 48 x 120	8-10	180	
2+ 48 x 144	10	216	
2+ 48 x 168	10	252	
** 60 x 96	8-10	180	
2+ 60 x 120	10-12	225	
2+ 60 x 144	10-12	270	
2+ 60 x 168	12	315	

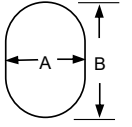
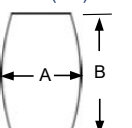
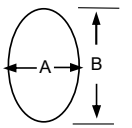
shape	A x B	seats	approximate weight (lbs)	
racetrack (RA). ** 	36 x 72	4	81	
	** 36 x 84	6	95	
	** 36 x 96	6-8	108	
	2+ 36 x 120	8	135	
	** 42 x 72	6	95	
	** 42 x 96	8	126	
	2+ 42 x 120	8	158	
	** 48 x 96	8-10	144	
	2+ 48 x 120	8-10	180	
	2+ 48 x 144	10	216	
	2+ 48 x 168	10	252	
	** 60 x 96	8-10	180	
2+ 60 x 120	10-12	225		
2+ 60 x 144	10-12	270		
2+ 60 x 168	12	315		
boat (BO). ** 	36 x 72	4	81	
	** 36 x 84	6	95	
	2+ 36 x 96	6-8	108	
	** 42 x 96	8	126	
	** 48 x 96	8-10	144	
	2+ 48 x 120	8-10	180	
	** 60 x 96	8-10	180	
	2+ 60 x 120	10-12	225	
	2+ 60 x 144	10-12	270	
	2+ 60 x 168	12	315	
	oval (OV). ** 	36 x 72	4	81
		** 36 x 84	6	95
** 36 x 96		6-8	108	
2+ 36 x 120		8	135	
** 42 x 72		6	95	
** 42 x 96		8	126	
** 48 x 96		8-10	144	
2+ 48 x 120		8-10	180	
2+ 48 x 144		10	216	
2+ 48 x 168		10	252	
** 60 x 96		8-10	180	
2+ 60 x 120		10-12	225	
2+ 60 x 144	10-12	270		
2+ 60 x 168	12	315		

\* 1 support bar included  
 \*\* 2 support bars included  
 2+ 2 piece top with bars + table lock set included

\*\*\* 120" - 144" two piece tops can be produced as one piece upon request with additional packaging and freight charges



Seating capacity is a guide only. Capacity will vary according to seating width, design and layout. Capacity based on 30" minimum width per seat and use on all potential sides.

For pricing on custom size 3mm edge (PVEA) surfaces just use next largest standard size price. For unusual shapes and other special pricing, email [service@symphonytables.com](mailto:service@symphonytables.com) for assistance.

# surfaces

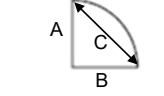
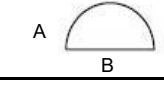
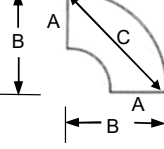
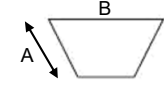
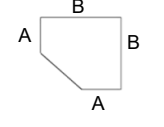
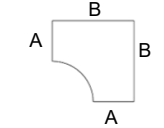
additional shapes, dimensions

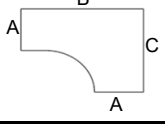
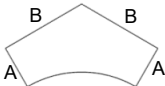

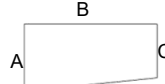



shape	A x B x C
quarter round (QR) 	18 x 18 x 25.5
	24 x 24 x 34
	30 x 30 x 42.5
half round (HA) 	18 x 36
	24 x 48
	30 x 60
crescent (CR) 	18 x 36 x 51
	24 x 48 x 68
	24 x 60 x 94
	30 x 60 x 96
trapezoid (TR) 	24 x 48 x 21
	30 x 60 x 26
	30 x 72 x 31
corner - angled (CA) 	24 x 36
	24 x 42
	24 x 48
corner - curved (CC) 	24 x 36
	24 x 42
	24 x 48

shape	A x B x C
corner - extended (CE) 	24 x 60 x 36
	24 x 72 x 36
	24 x 60 x 48
	24 x 72 x 48
corner - 120 degree (12) 	24 x 36
	24 x 42
	24 x 48
	24 x 36 x 60
wedge (WE) 	24 x 36 x 30
	24 x 42 x 30
	24 x 48 x 30
	24 x 60 x 30
wedge (WE) 	30 x 36 x 24
	30 x 42 x 24
	30 x 48 x 24
	30 x 60 x 24



# surfaces

PVEA & PVRC 3mm eased edge  
round, squircle, square and small rectangle





shape	dimension	model no.	grade 1 list	grade 2 list
 round (PVEA edge)	18	SLRD18000PVEA	260	300
	20	SLRD20000PVEA	280	320
	24	SLRD24000PVEA	310	340
	30	SLRD30000PVEA	410	460
	36	SLRD36000PVEA	520	590
	42	SLRD42000PVEA	770	890
	48	SLRD48000PVEA	800	910
	54	SLRD54000PVEA	1,150	1,340
	60	SLRD60000PVEA	1,180	1,360
 squircle (PVEA edge)	30 x 30	SLSC30030PVEA	410	460
	36 x 36	SLSC36036PVEA	520	590
	42 x 42	SLSC42042PVEA	770	890
	48 x 48	SLSC48048PVEA	800	910
	54 x 54	SLSC54054PVEA	1150	1340
	60 x 60	SLSC60060PVEA	1180	1360
 square (PVEA edge) 90 degree corners	18 x 18	SLSQ18018PVEA	260	300
	20 x 20	SLSQ20020PVEA	280	320
	24 x 24	SLSQ24024PVEA	310	340
	30 x 30	SLSQ30030PVEA	410	460
	36 x 36	SLSQ36036PVEA	520	590
	42 x 42	SLSQ42042PVEA	770	890
	48 x 48	SLSQ48048PVEA	800	910
	54 x 54	SLSQ54054PVEA	1,150	1,340
60 x 60	SLSQ60060PVEA	1,180	1,360	
 square (PVRC edge) 3" radius corners	18 x 18	SLSQ18018PVRC	280	320
	20 x 20	SLSQ20020PVRC	300	340
	24 x 24	SLSQ24024PVRC	330	370
	30 x 30	SLSQ30030PVRC	440	490
	36 x 36	SLSQ36036PVRC	560	640
	42 x 42	SLSQ42042PVRC	830	960
	48 x 48	SLSQ48048PVRC	850	980
	54 x 54	SLSQ54054PVRC	1,240	1450
60 x 60	SLSQ60060PVRC	1,270	1470	
 rectangle (PVEA) 90 degree corners	12 x 18	SLRE12018PVEA	240	280
	14 x 20	SLRE14020PVEA	260	300
 rectangle (PVRC edge) 3" radius corners	12 x 18	SLRE12018PVRC	260	300
	14 x 20	SLRE14020PVRC	280	320

Additional edge profiles and top dimensions are available. Please contact Symphony for details.

Formica + Wilsonart HPL laminate finish grades listed on pages 6-13. For additional laminate grades, contact Symphony.

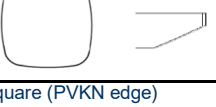
# surfaces

PVKN & PVKR 3mm knife edge  
round, squircle, square and small rectangle

shape	dimension	model no. (raw MDF edge)	grade 1 list (raw MDF edge)	grade 2 list (raw MDF edge)	model no. (painted edge)	grade 1 list (black or white painted edge)	grade 2 list (black or white painted edge)	
 round (PVKN edge)	18	SLRD18000PVKN	350	410	SLRD18000PVKN-P	420	480	
	20	SLRD20000PVKN	380	430	SLRD20000PVKN-P	460	510	
	24	SLRD24000PVKN	400	450	SLRD24000PVKN-P	500	550	
	30	SLRD30000PVKN	540	620	SLRD30000PVKN-P	660	740	
	36	SLRD36000PVKN	690	800	SLRD36000PVKN-P	830	940	
	42	SLRD42000PVKN	1,050	1,230	SLRD42000PVKN-P	1,220	1,400	
	48	SLRD48000PVKN	1,080	1,250	SLRD48000PVKN-P	1,270	1,440	
	54	SLRD54000PVKN	1,590	1,870	SLRD54000PVKN-P	1,800	2,080	
	60	SLRD60000PVKN	1,620	1,890	SLRD60000PVKN-P	1,860	2,130	
	 squircle (PVKN edge)	30 x 30	SLSC30030PVKN	540	620	SLSC30030PVKN-P	660	740
36 x 36		SLSC36036PVKN	690	800	SLSC36036PVKN-P	830	940	
42 x 42		SLSC42042PVKN	1050	1,230	SLSC42042PVKN-P	1,220	1,400	
48 x 48		SLSC48048PVKN	1,080	1,250	SLSC48048PVKN-P	1,270	1,440	
54 x 54		SLSC54054PVKN	1,590	1,870	SLSC54054PVKN-P	1,800	2,080	
60 x 60		SLSC60060PVKN	1,620	1,890	SLSC60060PVKN-P	1,860	2,130	
 square (PVKN edge) 90 degree corners	18 x 18	SLSQ18018PVKN	350	410	SLSQ18018PVKN-P	440	500	
	20 x 20	SLSQ20020PVKN	380	430	SLSQ20020PVKN-P	480	530	
	24 x 24	SLSQ24024PVKN	400	450	SLSQ24024PVKN-P	520	570	
	30 x 30	SLSQ30030PVKN	540	620	SLSQ30030PVKN-P	690	770	
	36 x 36	SLSQ36036PVKN	690	800	SLSQ36036PVKN-P	870	980	
	42 x 42	SLSQ42042PVKN	1,050	1,230	SLSQ42042PVKN-P	1,260	1,440	
	48 x 48	SLSQ48048PVKN	1,080	1,250	SLSQ48048PVKN-P	1,320	1,490	
	54 x 54	SLSQ54054PVKN	1,590	1,870	SLSQ54054PVKN-P	1,860	2,140	
60 x 60	SLSQ60060PVKN	1,620	1,890	SLSQ60060PVKN-P	1,920	2,190		
 square (PVKR edge) 3" radius corners	18 x 18	SLSQ18018PVKR	380	440	SLSQ18018PVKR-P	470	530	
	20 x 20	SLSQ20020PVKR	400	470	SLSQ20020PVKR-P	500	570	
	24 x 24	SLSQ24024PVKR	430	490	SLSQ24024PVKR-P	550	610	
	30 x 30	SLSQ30030PVKR	580	660	SLSQ30030PVKR-P	730	810	
	36 x 36	SLSQ36036PVKR	750	860	SLSQ36036PVKR-P	930	1,040	
	42 x 42	SLSQ42042PVKR	1,140	1,330	SLSQ42042PVKR-P	1,350	1,540	
 rectangle (PVKN) 90 degree corners	12 x 18	SLRE12018PVKN	330	390	SLRE12018PVKN-P	410	470	
	14 x 20	SLRE14020PVKN	350	410	SLRE14020PVKN-P	440	500	
	 rectangle (PVKR edge) 3" radius corners	12 x 18	SLRE12018PVKR	360	420	SLRE12018PVKR-P	440	500
		14 x 20	SLRE14020PVKR	380	440	SLRE14020PVKR-P	470	530

PVKN and PVKR edge detail:

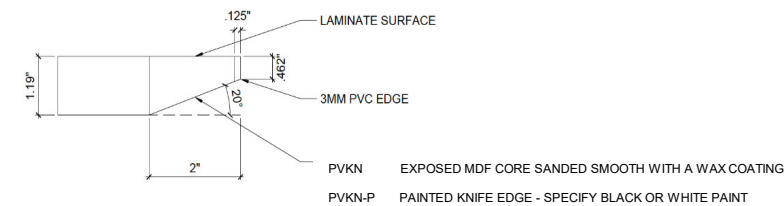

# surfaces

PVEA & PVRC 3mm eased edge rectangle

shape	dimension	model no.	grade 1 list	grade 2 list
rectangle (PVEA edge) 90 degree corners	18 x 36	SLRE18036PVEA	300	360
	18 x 42	SLRE18042PVEA	350	410
	18 x 48	SLRE18048PVEA	370	430
	18 x 54	SLRE18054PVEA	530	600
	18 x 60	SLRE18060PVEA	540	610
	18 x 66	SLRE18066PVEA	580	660
	18 x 72	SLRE18072PVEA	600	690
	18 x 84	SLRE18084PVEA	750	860
	18 x 90	SLRE18090PVEA	790	900
	18 x 96	SLRE18096PVEA	800	910
	24 x 30	SLRE24030PVEA	320	370
	24 x 36	SLRE24036PVEA	340	390
	24 x 42	SLRE24042PVEA	360	420
	24 x 48	SLRE24048PVEA	390	450
	24 x 54	SLRE24054PVEA	540	620
	24 x 60	SLRE24060PVEA	550	620
	24 x 66	SLRE24066PVEA	590	670
	24 x 72	SLRE24072PVEA	610	700
	24 x 84	SLRE24084PVEA	760	870
	24 x 90	SLRE24090PVEA	810	920
24 x 96	SLRE24096PVEA	820	930	
30 x 36	SLRE30036PVEA	420	490	
30 x 42	SLRE30042PVEA	440	510	
30 x 48	SLRE30048PVEA	470	540	
30 x 54	SLRE30054PVEA	690	780	
30 x 60	SLRE30060PVEA	710	800	
30 x 66	SLRE30066PVEA	770	870	
30 x 72	SLRE30072PVEA	810	910	
30 x 84	SLRE30084PVEA	1,110	1,260	
30 x 90	SLRE30090PVEA	1,140	1,280	
30 x 96	SLRE30096PVEA	1,150	1,300	
rectangle (PVRC edge) 3" radius corners	18 x 36	SLRE18036PVRC	330	370
	18 x 42	SLRE18042PVRC	380	450
	18 x 48	SLRE18048PVRC	400	470
	18 x 54	SLRE18054PVRC	570	650
	18 x 60	SLRE18060PVRC	580	660
	18 x 66	SLRE18066PVRC	620	710
	18 x 72	SLRE18072PVRC	650	730
	18 x 84	SLRE18084PVRC	800	920
	18 x 90	SLRE18090PVRC	840	970
	18 x 96	SLRE18096PVRC	850	980
	24 x 30	SLRE24030PVRC	340	390
	24 x 36	SLRE24036PVRC	370	420
	24 x 42	SLRE24042PVRC	390	460
	24 x 48	SLRE24048PVRC	420	490
	24 x 54	SLRE24054PVRC	580	660
	24 x 60	SLRE24060PVRC	590	670
	24 x 66	SLRE24066PVRC	630	720
	24 x 72	SLRE24072PVRC	650	740
	24 x 84	SLRE24084PVRC	820	930
	24 x 90	SLRE24090PVRC	870	990
24 x 96	SLRE24096PVRC	880	1000	
30 x 36	SLRE30036PVRC	460	530	
30 x 42	SLRE30042PVRC	480	560	
30 x 48	SLRE30048PVRC	500	590	
30 x 54	SLRE30054PVRC	740	840	
30 x 60	SLRE30060PVRC	750	850	
30 x 66	SLRE30066PVRC	820	930	
30 x 72	SLRE30072PVRC	860	970	
30 x 84	SLRE30084PVRC	1,180	1,340	
30 x 90	SLRE30090PVRC	1,210	1,370	
30 x 96	SLRE30096PVRC	1,230	1,390	

Formica + Wilsonart HPL laminate finish grades listed on pages 6-13. For additional laminate grades, contact Symphony.

\* 1 support bar included

\*\* 2 support bars included

# surfaces

PVKN & PVKR 3mm knife edge rectangle

shape	dimension	model no. (raw MDF edge)	grade 1 list (raw MDF edge)	grade 2 list (raw MDF edge)	model no. (painted edge)	grade 1 list (black or white painted edge)	grade 2 list (black or white painted edge)
rectangle (PVKN edge) 90 degree corners	18 x 36	SLRE18036PVKN	340	400	SLRE18036PVKN-P	450	500
	18 x 42	SLRE18042PVKN	490	580	SLRE18042PVKN-P	630	710
	18 x 48	SLRE18048PVKN	520	600	SLRE18048PVKN-P	670	760
	18 x 54	SLRE18054PVKN	710	820	SLRE18054PVKN-P	880	990
	18 x 60	SLRE18060PVKN	720	830	SLRE18060PVKN-P	910	1,020
	18 x 66	SLRE18066PVKN	780	900	SLRE18066PVKN-P	990	1,110
	18 x 72	SLRE18072PVKN	800	920	SLRE18072PVKN-P	1,030	1,150
	18 x 84	SLRE18084PVKN	1,010	1,170	SLRE18084PVKN-P	1,280	1,430
	18 x 90	SLRE18090PVKN	1,060	1,230	SLRE18090PVKN-P	1,350	1,520
	18 x 96	SLRE18096PVKN	1,070	1,240	SLRE18096PVKN-P	1,380	1,540
	24 x 30	SLRE24030PVKN	430	500	SLRE24030PVKN-P	560	630
	24 x 36	SLRE24036PVKN	460	540	SLRE24036PVKN-P	620	700
	24 x 42	SLRE24042PVKN	500	590	SLRE24042PVKN-P	680	760
	24 x 48	SLRE24048PVKN	540	630	SLRE24048PVKN-P	740	830
	24 x 54	SLRE24054PVKN	720	830	SLRE24054PVKN-P	950	1,060
	24 x 60	SLRE24060PVKN	730	840	SLRE24060PVKN-P	980	1,100
	24 x 66	SLRE24066PVKN	790	910	SLRE24066PVKN-P	1,070	1,190
	24 x 72	SLRE24072PVKN	810	930	SLRE24072PVKN-P	1,120	1,240
	24 x 84	SLRE24084PVKN	1,020	1,180	SLRE24084PVKN-P	1,380	1,540
	24 x 90	SLRE24090PVKN	1,080	1,250	SLRE24090PVKN-P	1,470	1,630
24 x 96	SLRE24096PVKN	1,090	1,260	SLRE24096PVKN-P	1,500	1,670	
30 x 36	SLRE30036PVKN	580	680	SLRE30036PVKN-P	770	870	
30 x 42	SLRE30042PVKN	610	710	SLRE30042PVKN-P	830	940	
30 x 48	SLRE30048PVKN	650	760	SLRE30048PVKN-P	900	1,010	
30 x 54	SLRE30054PVKN	910	1,040	SLRE30054PVKN-P	1,200	1,330	
30 x 60	SLRE30060PVKN	920	1,060	SLRE30060PVKN-P	1,240	1,380	
30 x 66	SLRE30066PVKN	1,000	1,150	SLRE30066PVKN-P	1,360	1,500	
30 x 72	SLRE30072PVKN	1,050	1,190	SLRE30072PVKN-P	1,430	1,580	
30 x 84	SLRE30084PVKN	1,460	1,680	SLRE30084PVKN-P	1,910	2,120	
30 x 90	SLRE30090PVKN	1,490	1,710	SLRE30090PVKN-P	1,970	2,190	
30 x 96	SLRE30096PVKN	1,500	1,720	SLRE30096PVKN-P	2,020	2,230	
rectangle (PVKR edge) 3" radius corners	18 x 36	SLRE18036PVKR	370	440	SLRE18036PVKR-P	480	530
	18 x 42	SLRE18042PVKR	530	630	SLRE18042PVKR-P	670	760
	18 x 48	SLRE18048PVKR	560	660	SLRE18048PVKR-P	710	810
	18 x 54	SLRE18054PVKR	760	880	SLRE18054PVKR-P	940	1,060
	18 x 60	SLRE18060PVKR	770	900	SLRE18060PVKR-P	970	1,090
	18 x 66	SLRE18066PVKR	840	970	SLRE18066PVKR-P	1,050	1,180
	18 x 72	SLRE18072PVKR	860	990	SLRE18072PVKR-P	1,090	1,220
	18 x 84	SLRE18084PVKR	1,090	1,260	SLRE18084PVKR-P	1,350	1,530
	18 x 90	SLRE18090PVKR	1,140	1,330	SLRE18090PVKR-P	1,430	1,620
	18 x 96	SLRE18096PVKR	1,150	1,340	SLRE18096PVKR-P	1,460	1,650
	24 x 30	SLRE24030PVKR	460	540	SLRE24030PVKR-P	590	670
	24 x 36	SLRE24036PVKR	500	590	SLRE24036PVKR-P	660	740
	24 x 42	SLRE24042PVKR	540	640	SLRE24042PVKR-P	720	810
	24 x 48	SLRE24048PVKR	580	680	SLRE24048PVKR-P	790	890
	24 x 54	SLRE24054PVKR	780	900	SLRE24054PVKR-P	1,010	1,130
	24 x 60	SLRE24060PVKR	780	910	SLRE24060PVKR-P	1,040	1,160
	24 x 66	SLRE24066PVKR	850	980	SLRE24066PVKR-P	1,130	1,260
	24 x 72	SLRE24072PVKR	870	1,000	SLRE24072PVKR-P	1,180	1,310
	24 x 84	SLRE24084PVKR	1,100	1,270	SLRE24084PVKR-P	1,460	1,630
	24 x 90	SLRE24090PVKR	1,170	1,350	SLRE24090PVKR-P	1,550	1,740
24 x 96	SLRE24096PVKR	1,180	1,360	SLRE24096PVKR-P	1,590	1,770	
30 x 36	SLRE30036PVKR	630	740	SLRE30036PVKR-P	820	930	
30 x 42	SLRE30042PVKR	660	780	SLRE30042PVKR-P	890	1,000	
30 x 48	SLRE30048PVKR	700	820	SLRE30048PVKR-P	960	1,080	
30 x 54	SLRE30054PVKR	980	1,120	SLRE30054PVKR-P	1,260	1,410	
30 x 60	SLRE30060PVKR	990	1,140	SLRE30060PVKR-P	1,310	1,450	
30 x 66	SLRE30066PVKR	1,080	1,240	SLRE30066PVKR-P	1,430	1,590	
30 x 72	SLRE30072PVKR	1,120	1,280	SLRE30072PVKR-P	1,500	1,660	
30 x 84	SLRE30084PVKR	1,570	1,810	SLRE30084PVKR-P	2,020	2,250	
30 x 90	SLRE30090PVKR	1,600	1,840	SLRE30090PVKR-P	2,080	2,320	
30 x 96	SLRE30096PVKR	1,610	1,850	SLRE30096PVKR-P	2,120	2,360	

Additional edge profiles and top dimensions are available. Please contact Symphony for details.

# surfaces

PVEA 3mm eased edge

1 piece conference: rectangle, boat, oval, racetrack

For complete model number:

1. insert 2 character top shape code (rectangle **RE**, boat **BO**, oval **OV**, or racetrack **RA**)

For example 36" x 42" rectangle top #SL**RE**36042PVEA



rectangle (**RE**)



boat (**BO**)

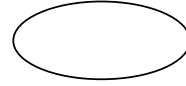

oval (**OV**)

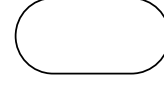

racetrack (**RA**)

edge	dimension	model no.	grade 1 list	grade 2 list	
	36 x 42	SL__36042PVEA	510	590	
	36 x 48	SL__36048PVEA	560	650	
	** 36 x 54	SL__36054PVEA	830	890	
	** 36 x 60	SL__36060PVEA	840	900	
	** 36 x 66	SL__36066PVEA	910	1,000	
	** 36 x 72	SL__36072PVEA	940	1,040	
	** 36 x 84	SL__36084PVEA	1,260	1,400	
	** 36 x 90	SL__36090PVEA	1,310	1,440	
	** 36 x 96	SL__36096PVEA	1,320	1,460	
		42 x 48	SL__42048PVEA	710	830
** 42 x 54		SL__42054PVEA	870	960	
** 42 x 60		SL__42060PVEA	1,040	1,150	
** 42 x 66		SL__42066PVEA	1,190	1,340	
** 42 x 72		SL__42072PVEA	1,240	1,380	
** 42 x 84		SL__42084PVEA	1,600	1,790	
** 42 x 90		SL__42090PVEA	1,650	1,830	
** 42 x 96		SL__42096PVEA	1,660	1,860	
		** 48 x 54	SL__48054PVEA	1,040	1,140
		** 48 x 60	SL__48060PVEA	1,050	1,150
	** 48 x 66	SL__48066PVEA	1,210	1,340	
	** 48 x 72	SL__48072PVEA	1,240	1,380	
	** 48 x 84	SL__48084PVEA	1,600	1,790	
	** 48 x 90	SL__48090PVEA	1,650	1,830	
	** 48 x 96	SL__48096PVEA	1,660	1,860	
		** 54 x 60	SL__54060PVEA	1,430	1,610
		** 54 x 66	SL__54066PVEA	1,460	1,630
		** 54 x 72	SL__54072PVEA	1,510	1,680
** 54 x 84		SL__54084PVEA	1,930	2,160	
** 54 x 90		SL__54090PVEA	2,010	2,260	
** 54 x 96		SL__54096PVEA	2,030	2,280	
		** 60 x 66	SL__60066PVEA	1,460	1,630
		** 60 x 72	SL__60072PVEA	1,510	1,680
		** 60 x 84	SL__60084PVEA	1,930	2,160
		** 60 x 90	SL__60090PVEA	2,010	2,260
	** 60 x 96	SL__60096PVEA	2,030	2,280	

Formica + Wilsonart HPL laminate finish grades listed on pages 6-13 For additional laminate grades, contact Symphony.

\*\* 2 support bars included

Radius corners available for rectangle and boat shaped tops - contact Symphony for details and pricing.

# surfaces

PVKN 3mm knife edge

1 piece conference: rectangle, boat, oval, racetrack

For complete model number:

1. insert 2 character top shape code (rectangle **RE**, boat **BO**, oval **OV**, or racetrack **RA**)

For example 36" x 42" rectangle top #SL**RE**36042PVKN



rectangle (**RE**)



boat (**BO**)



oval (**OV**)



racetrack (**RA**)

edge	dimension	model no. (natural waxed MDF edge)	grade 1 list (natural waxed MDF edge)	grade 2 list (natural waxed MDF edge)	model no. (painted edge)	grade 1 list (black or white painted edge)	grade 2 list (black or white painted edge)	
	36 x 42	SL__36042PVKN	700	830	SL__36042PVKN-P	900	1,030	
	36 x 48	SL__36048PVKN	780	910	SL__36048PVKN-P	990	1,120	
	** 36 x 54	SL__36054PVKN	1,050	1,210	SL__36054PVKN-P	1,280	1,440	
	** 36 x 60	SL__36060PVKN	1,060	1,220	SL__36060PVKN-P	1,300	1,460	
	** 36 x 66	SL__36066PVKN	1,170	1,360	SL__36066PVKN-P	1,430	1,620	
	** 36 x 72	SL__36072PVKN	1,210	1,400	SL__36072PVKN-P	1,480	1,670	
	** 36 x 84	SL__36084PVKN	1,640	1,900	SL__36084PVKN-P	1,940	2,200	
	** 36 x 90	SL__36090PVKN	1,680	1,940	SL__36090PVKN-P	2,000	2,260	
	** 36 x 96	SL__36096PVKN	1,710	1,970	SL__36096PVKN-P	2,040	2,300	
		42 x 48	SL__42048PVKN	990	1,170	SL__42048PVKN-P	1,220	1,400
** 42 x 54		SL__42054PVKN	1,130	1,300	SL__42054PVKN-P	1,370	1,540	
** 42 x 60		SL__42060PVKN	1,350	1,570	SL__42060PVKN-P	1,610	1,830	
** 42 x 66		SL__42066PVKN	1,580	1,850	SL__42066PVKN-P	1,850	2,120	
** 42 x 72		SL__42072PVKN	1,620	1,880	SL__42072PVKN-P	1,910	2,170	
** 42 x 84		SL__42084PVKN	2,120	2,470	SL__42084PVKN-P	2,440	2,790	
** 42 x 90		SL__42090PVKN	2,160	2,510	SL__42090PVKN-P	2,490	2,840	
** 42 x 96		SL__42096PVKN	2,190	2,530	SL__42096PVKN-P	2,540	2,880	
		** 48 x 54	SL__48054PVKN	1,340	1,560	SL__48054PVKN-P	1,600	1,820
		** 48 x 60	SL__48060PVKN	1,350	1,570	SL__48060PVKN-P	1,620	1,840
	** 48 x 66	SL__48066PVKN	1,580	1,850	SL__48066PVKN-P	1,870	2,140	
	** 48 x 72	SL__48072PVKN	1,620	1,880	SL__48072PVKN-P	1,920	2,180	
	** 48 x 84	SL__48084PVKN	2,120	2,470	SL__48084PVKN-P	2,450	2,800	
	** 48 x 90	SL__48090PVKN	2,160	2,510	SL__48090PVKN-P	2,510	2,860	
	** 48 x 96	SL__48096PVKN	2,190	2,530	SL__48096PVKN-P	2,550	2,890	
		** 54 x 60	SL__54060PVKN	1,920	2,240	SL__54060PVKN-P	2,210	2,530
		** 54 x 66	SL__54066PVKN	1,940	2,270	SL__54066PVKN-P	2,240	2,570
		** 54 x 72	SL__54072PVKN	1,990	2,320	SL__54072PVKN-P	2,310	2,640
** 54 x 84		SL__54084PVKN	2,560	2,980	SL__54084PVKN-P	2,910	3,330	
** 54 x 90		SL__54090PVKN	2,670	3,100	SL__54090PVKN-P	3,030	3,460	
** 54 x 96		SL__54096PVKN	2,690	3,130	SL__54096PVKN-P	3,070	3,510	
		** 60 x 66	SL__60066PVKN	1,940	2,270	SL__60066PVKN-P	2,260	2,590
		** 60 x 72	SL__60072PVKN	1,990	2,320	SL__60072PVKN-P	2,320	2,650
		** 60 x 84	SL__60084PVKN	2,560	2,980	SL__60084PVKN-P	2,920	3,340
		** 60 x 90	SL__60090PVKN	2,670	3,100	SL__60090PVKN-P	3,050	3,480
	** 60 x 96	SL__60096PVKN	2,690	3,130	SL__60096PVKN-P	3,080	3,520	

Formica + Wilsonart HPL laminate finish grades listed on pages 6-13 For additional laminate grades, contact Symphony.

\*\* 2 support bars included

Radius corners available for rectangle and boat shaped tops - contact Symphony for details and pricing.

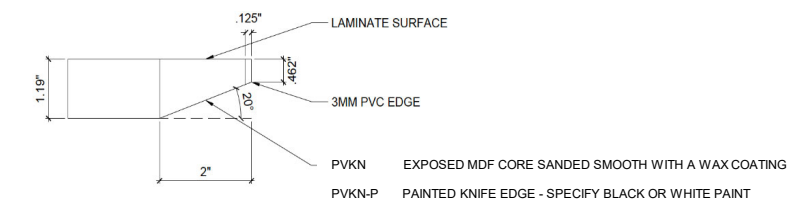

# surfaces

PVEA 3mm eased edge

2 piece conference: rectangle, boat, oval, racetrack

For complete model number:

1. insert 2 character top shape code (rectangle **RE**, boat **BO**, oval **OV**, or racetrack **RA**)  
For example 36" x 42" rectangle top #SL**RE**36042PVEA



edge	dimension	model no.	PVEA grade 1 list	PVEA grade 2 list	grain match model no.	grain match grade 1 list upcharge	grain match grade 2 list upcharge
PVEA	2+ 36 x 120	SL_36120PVEA	1,560	1,730	OTGRMTCH36120	240	310
	2+ 36 x 144	SL_36144PVEA	1,770	1,950	OTGRMTCH36144	290	380
	2+ 42 x 120	SL_42120PVEA	1,940	2,180	OTGRMTCH42120	290	370
	2+ 42 x 144	SL_42144PVEA	2,310	2,590	OTGRMTCH42144	340	440
	2+ 42 x 168	SL_42168PVEA	2,730	3,090	OTGRMTCH42168	400	510
	2+ 42 x 192	SL_42192PVEA	3,120	3,540	OTGRMTCH42192	460	590
	2+ 48 x 120	SL_48120PVEA	1,960	2,190	OTGRMTCH48120	330	420
	2+ 48 x 144	SL_48144PVEA	2,310	2,590	OTGRMTCH48144	390	500
	2+ 48 x 168	SL_48168PVEA	2,750	3,090	OTGRMTCH48168	460	590
	2+ 48 x 192	SL_48192PVEA	3,140	3,540	OTGRMTCH48192	520	670
	2+ 54 x 120	SL_54120PVEA	2,350	2,650	OTGRMTCH54120	370	470
	2+ 54 x 144	SL_54144PVEA	2,800	3,170	OTGRMTCH54144	440	570
	2+ 54 x 168	SL_54168PVEA	3,680	4,190	OTGRMTCH54168	510	660
	2+ 54 x 192	SL_54192PVEA	3,770	4,290	OTGRMTCH54192	590	750
	2+ 60 x 120	SL_60120PVEA	2,350	2,650	OTGRMTCH60120	410	520
	2+ 60 x 144	SL_60144PVEA	2,800	3,170	OTGRMTCH60144	490	630
	2+ 60 x 168	SL_60168PVEA	3,680	4,190	OTGRMTCH60168	570	730
	2+ 60 x 192	SL_60192PVEA	3,770	4,290	OTGRMTCH60192	650	840

Formica + Wilsonart HPL laminate finish grades listed on pages 6-13. For additional laminate grades, contact Symphony.

2+ 2 piece top with bars + table lock set included

**Grain Match fees for 2 piece tops with a wood grain laminate**

See above chart, use model number OTGRMTCH with the top depth x length-Gr1 or Gr2 - for example OTGRMTCH36120-GR1

Radius corners available for rectangle and boat shaped tops - contact Symphony for pricing.

PVKN or PVKN-P EDGE DETAIL (pricing on opposite page)

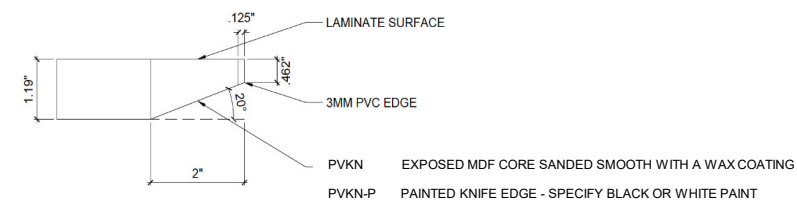

# surfaces

PVKN 3mm knife edge

2 piece conference: rectangle, boat, oval, racetrack

For complete model number:

1. insert 2 character top shape code (rectangle **RE**, boat **BO**, oval **OV**, or racetrack **RA**)  
For example 36" x 42" rectangle top #SL**RE**36042PVKN



edge	dimension	model no. (natural waxed MDF edge)	grade 1 list (natural waxed MDF edge)	grade 2 list (natural waxed MDF edge)	grain match model no.	grain match grade 1 list upcharge	grain match grade 2 list upcharge
PVKN (natural waxed MDF)	2+ 36 x 120	SL_36120PVKN	2,040	2,370	OTGRMTCH36120	240	310
	2+ 36 x 144	SL_36144PVKN	2,300	2,670	OTGRMTCH36144	290	380
	2+ 42 x 120	SL_42120PVKN	2,570	3,010	OTGRMTCH42120	290	370
	2+ 42 x 144	SL_42144PVKN	3,090	3,610	OTGRMTCH42144	340	440
	2+ 42 x 168	SL_42168PVKN	3,670	4,270	OTGRMTCH42168	400	510
	2+ 42 x 192	SL_42192PVKN	4,190	4,890	OTGRMTCH42192	460	590
	2+ 48 x 120	SL_48120PVKN	2,570	3,010	OTGRMTCH48120	330	420
	2+ 48 x 144	SL_48144PVKN	3,090	3,610	OTGRMTCH48144	390	500
	2+ 48 x 168	SL_48168PVKN	3,670	4,270	OTGRMTCH48168	460	590
	2+ 48 x 192	SL_48192PVKN	4,190	4,890	OTGRMTCH48192	520	670
	2+ 54 x 120	SL_54120PVKN	3,160	3,700	OTGRMTCH54120	370	470
	2+ 54 x 144	SL_54144PVKN	3,780	4,430	OTGRMTCH54144	440	570
	2+ 54 x 168	SL_54168PVKN	5,010	5,880	OTGRMTCH54168	510	660
	2+ 54 x 192	SL_54192PVKN	5,110	5,980	OTGRMTCH54192	590	750
	2+ 60 x 120	SL_60120PVKN	3,160	3,700	OTGRMTCH60120	410	520
	2+ 60 x 144	SL_60144PVKN	3,780	4,430	OTGRMTCH60144	490	630
	2+ 60 x 168	SL_60168PVKN	5,010	5,880	OTGRMTCH60168	570	730
	2+ 60 x 192	SL_60192PVKN	5,110	5,980	OTGRMTCH60192	650	840

edge	dimension	model no. (painted edge)	grade 1 list (painted edge)	grade 2 list (painted edge)	grain match model no.	grain match grade 1 list upcharge	grain match grade 2 list upcharge
PVKN-P (painted)	2+ 36 x 120	SL_36120PVKN-P	2,430	2,760	OTGRMTCH36120	240	310
	2+ 36 x 144	SL_36144PVKN-P	2,750	3,120	OTGRMTCH36144	290	380
	2+ 42 x 120	SL_42120PVKN-P	2,980	3,420	OTGRMTCH42120	290	370
	2+ 42 x 144	SL_42144PVKN-P	3,560	4,080	OTGRMTCH42144	340	440
	2+ 42 x 168	SL_42168PVKN-P	4,200	4,800	OTGRMTCH42168	400	510
	2+ 42 x 192	SL_42192PVKN-P	4,780	5,480	OTGRMTCH42192	460	590
	2+ 48 x 120	SL_48120PVKN-P	2,990	3,430	OTGRMTCH48120	330	420
	2+ 48 x 144	SL_48144PVKN-P	3,570	4,090	OTGRMTCH48144	390	500
	2+ 48 x 168	SL_48168PVKN-P	4,210	4,810	OTGRMTCH48168	460	590
	2+ 48 x 192	SL_48192PVKN-P	4,800	5,500	OTGRMTCH48192	520	670
	2+ 54 x 120	SL_54120PVKN-P	3,600	4,140	OTGRMTCH54120	370	470
	2+ 54 x 144	SL_54144PVKN-P	4,280	4,930	OTGRMTCH54144	440	570
	2+ 54 x 168	SL_54168PVKN-P	5,570	6,440	OTGRMTCH54168	510	660
	2+ 54 x 192	SL_54192PVKN-P	5,730	6,600	OTGRMTCH54192	590	750
	2+ 60 x 120	SL_60120PVKN-P	3,610	4,150	OTGRMTCH60120	410	520
	2+ 60 x 144	SL_60144PVKN-P	4,290	4,940	OTGRMTCH60144	490	630
	2+ 60 x 168	SL_60168PVKN-P	5,580	6,450	OTGRMTCH60168	570	730
	2+ 60 x 192	SL_60192PVKN-P	5,750	6,620	OTGRMTCH60192	650	840

Formica + Wilsonart HPL laminate finish grades listed on pages 6-13. For additional laminate grades, contact Symphony.

2+ 2 piece top with bars + table lock set included

**Grain Match fees for 2 piece tops with a wood grain laminate**

See above chart, use model number OTGRMTCH with the top depth x length-Gr1 or Gr2 - for example OTGRMTCH36120-GR1

Radius corners available for rectangle and boat shaped tops - contact Symphony for pricing.

# surfaces

PVEA 3mm eased edge and PVKN knife edge

conference: arc trapezoid & arc rectangle

For complete model number insert 2 character edge code: (PVEA for eased or PVKN for knife edge)

shape	dimension	model no.	PVEA grade 1 list	PVEA grade 2 list	PVKN grade 1 list	PVKN grade 2 list	grain match model no.	grain match grade 1 list upcharge	grain match grade 2 list upcharge
<b>arc trapezoid</b>									
**	60 x 96	SLAT60096PV	2,230	2,510	2,960	3,440	-	-	-
2+	60 x 120	SLAT60120PV	2,590	2,920	3,480	4,070	OTGRMTCH60120	410	520
2+	60 x 144	SLAT60144PV	3,080	3,490	4,160	4,870	OTGRMTCH60144	490	630
2+	60 x 168	SLAT60168PV	4,050	4,610	5,510	6,470	OTGRMTCH60168	570	730
2+	60 x 192	SLAT60192PV	4,150	4,720	5,620	6,580	OTGRMTCH60192	650	840
<b>arc rectangle</b>									
**	42 x 72	SLAR42072PV	1,360	1,520	1,780	2,070	-	-	-
**	42 x 84	SLAR42084PV	1,760	1,970	2,330	2,720	-	-	-
**	42 x 90	SLAR42090PV	1,820	2,010	2,380	2,760	-	-	-
**	42 x 96	SLAR42096PV	1,830	2,050	2,410	2,780	-	-	-
2+	42 x 120	SLAR42120PV	2,130	2,400	2,830	3,310	OTGRMTCH42120	290	370
2+	42 x 144	SLAR42144PV	2,540	2,850	3,400	3,970	OTGRMTCH42144	340	440
2+	42 x 168	SLAR42168PV	3,000	3,400	4,040	4,700	OTGRMTCH42168	400	510
2+	42 x 192	SLAR42192PV	3,430	3,890	4,610	5,380	OTGRMTCH42192	460	590
**	48 x 72	SLAR48072PV	1,360	1,520	1,780	2,070	-	-	-
**	48 x 84	SLAR48084PV	1,760	1,970	2,330	2,720	-	-	-
**	48 x 90	SLAR48090PV	1,820	2,010	2,380	2,760	-	-	-
**	48 x 96	SLAR48096PV	1,830	2,050	2,410	2,780	-	-	-
2+	48 x 120	SLAR48120PV	2,160	2,410	2,830	3,310	OTGRMTCH48120	330	420
2+	48 x 144	SLAR48144PV	2,540	2,850	3,400	3,970	OTGRMTCH48144	390	500
2+	48 x 168	SLAR48168PV	3,030	3,400	4,040	4,700	OTGRMTCH48168	460	590
2+	48 x 192	SLAR48192PV	3,450	3,890	4,610	5,380	OTGRMTCH48192	520	670
**	54 x 72	SLAR54072PV	1,660	1,850	2,190	2,550	-	-	-
**	54 x 84	SLAR54084PV	2,120	2,380	2,820	3,280	-	-	-
**	54 x 90	SLAR54090PV	2,210	2,490	2,940	3,410	-	-	-
**	54 x 96	SLAR54096PV	2,230	2,510	2,960	3,440	-	-	-
2+	54 x 120	SLAR54120PV	2,590	2,920	3,480	4,070	OTGRMTCH54120	370	470
2+	54 x 144	SLAR54144PV	3,080	3,490	4,160	4,870	OTGRMTCH54144	440	570
2+	54 x 168	SLAR54168PV	4,050	4,610	5,510	6,470	OTGRMTCH54168	510	660
2+	54 x 192	SLAR54192PV	4,150	4,720	5,620	6,580	OTGRMTCH54192	590	750
**	60 x 72	SLAR60072PV	1,660	1,850	2,190	2,550	-	-	-
**	60 x 84	SLAR60084PV	2,120	2,380	2,820	3,280	-	-	-
**	60 x 90	SLAR60090PV	2,210	2,490	2,940	3,410	-	-	-
**	60 x 96	SLAR60096PV	2,230	2,510	2,960	3,440	-	-	-
2+	60 x 120	SLAR60120PV	2,590	2,920	3,480	4,070	OTGRMTCH60120	410	520
2+	60 x 144	SLAR60144PV	3,080	3,490	4,160	4,870	OTGRMTCH60144	490	630
2+	60 x 168	SLAR60168PV	4,050	4,610	5,510	6,470	OTGRMTCH60168	570	730
2+	60 x 192	SLAR60192PV	4,150	4,720	5,620	6,580	OTGRMTCH60192	650	840

Formica + Wilsonart HPL laminate finish grades listed on pages 6-13.  
For additional laminate grades, contact Symphony.

\*\* 2 support bars included  
2+ 2 piece top with bars + table lock set included

**Grain Match fees for 2 piece tops with a wood grain laminate**

See above chart, use model number OTGRMTCH with the top depth x length-Gr1 or Gr2 - for example OTGRMTCH36120-GR1

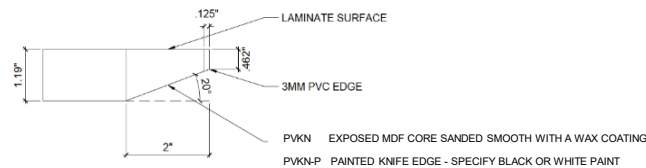

# surfaces

PVEA 3mm eased edge and PVKN knife edge

media: half arced rectangle, half boat, trapezoid media, bullet media

For complete model number:

1. insert 2 character top shape code (half arced rectangle **HR**, half boat **HB**, trapezoid media **TM**, or bullet media **BM**)
2. insert 2 character edge shape code (PVEA eased or PVKN knife)

shape	dimension	model no.	PVEA grade 1 list	PVEA grade 2 list	PVKN grade 1 list	PVKN grade 2 list	grain match model no.	grain match grade 1 list upcharge	grain match grade 2 list upcharge
<b>half arced rectangle (HR)</b>									
**	36 x 72	SL__36072PV	1,030	1,140	1,330	1,540	-	-	-
**	36 x 84	SL__36084PV	1,390	1,540	1,800	2,090	-	-	-
**	36 x 90	SL__36090PV	1,440	1,580	1,850	2,130	-	-	-
**	36 x 96	SL__36096PV	1,450	1,610	1,880	2,170	-	-	-
2+	36 x 120	SL__36120PV	1,720	1,900	2,240	2,610	OTGRMTCH36120	290	370
2+	36 x 144	SL__36144PV	1,950	2,150	2,530	2,940	OTGRMTCH36144	340	440
<b>half boat (HB)</b>									
**	42 x 72	SL__42072PV	1,360	1,520	1,780	2,070	-	-	-
**	42 x 84	SL__42084PV	1,760	1,970	2,330	2,720	-	-	-
**	42 x 90	SL__42090PV	1,820	2,010	2,380	2,760	-	-	-
**	42 x 96	SL__42096PV	1,830	2,050	2,410	2,780	-	-	-
2+	42 x 120	SL__42120PV	2,130	2,400	2,830	3,310	OTGRMTCH42120	290	370
2+	42 x 144	SL__42144PV	2,540	2,850	3,400	3,970	OTGRMTCH42144	340	440
2+	42 x 168	SL__42168PV	3,000	3,400	4,040	4,700	OTGRMTCH42168	400	510
2+	42 x 192	SL__42192PV	3,430	3,890	4,610	5,380	OTGRMTCH42192	460	590
<b>trapezoid media (TM)</b>									
**	48 x 72	SL__48072PV	1,360	1,520	1,780	2,070	-	-	-
**	48 x 84	SL__48084PV	1,760	1,970	2,330	2,720	-	-	-
**	48 x 90	SL__48090PV	1,820	2,010	2,380	2,760	-	-	-
**	48 x 96	SL__48096PV	1,830	2,050	2,410	2,780	-	-	-
2+	48 x 120	SL__48120PV	2,160	2,410	2,830	3,310	OTGRMTCH48120	330	420
2+	48 x 144	SL__48144PV	2,540	2,850	3,400	3,970	OTGRMTCH48144	390	500
2+	48 x 168	SL__48168PV	3,030	3,400	4,040	4,700	OTGRMTCH48168	460	590
2+	48 x 192	SL__48192PV	3,450	3,890	4,610	5,380	OTGRMTCH48192	520	670
<b>bullet media (BM)</b>									
**	54 x 72	SL__54072PV	1,660	1,850	2,190	2,550	-	-	-
**	54 x 84	SL__54084PV	2,120	2,380	2,820	3,280	-	-	-
**	54 x 90	SL__54090PV	2,210	2,490	2,940	3,410	-	-	-
**	54 x 96	SL__54096PV	2,230	2,510	2,960	3,440	-	-	-
2+	54 x 120	SL__54120PV	2,590	2,920	3,480	4,070	OTGRMTCH54120	370	470
2+	54 x 144	SL__54144PV	3,080	3,490	4,160	4,870	OTGRMTCH54144	440	570
2+	54 x 168	SL__54168PV	4,050	4,610	5,510	6,470	OTGRMTCH54168	510	660
2+	54 x 192	SL__54192PV	4,150	4,720	5,620	6,580	OTGRMTCH54192	590	750
**	60 x 72	SL__60072PV	1,660	1,850	2,190	2,550	-	-	-
**	60 x 84	SL__60084PV	2,120	2,380	2,820	3,280	-	-	-
**	60 x 90	SL__60090PV	2,210	2,490	2,940	3,410	-	-	-
**	60 x 96	SL__60096PV	2,230	2,510	2,960	3,440	-	-	-
2+	60 x 120	SL__60120PV	2,590	2,920	3,480	4,070	OTGRMTCH60120	410	520
2+	60 x 144	SL__60144PV	3,080	3,490	4,160	4,870	OTGRMTCH60144	490	630
2+	60 x 168	SL__60168PV	4,050	4,610	5,510	6,470	OTGRMTCH60168	570	730
2+	60 x 192	SL__60192PV	4,150	4,720	5,620	6,580	OTGRMTCH60192	650	840

Formica + Wilsonart HPL laminate finish grades listed on pages 6-13.  
For additional laminate grades, contact Symphony.

\*\* 2 support bars included  
2+ 2 piece top with bars + table lock set included

**Grain Match fees for 2 piece tops with a wood grain laminate**

See above chart, use model number OTGRMTCH with the top depth x length-Gr1 or Gr2 - for example OTGRMTCH36120-GR1

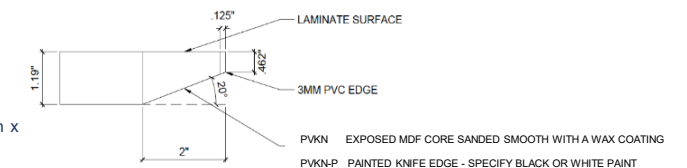

# surfaces

PVEA 3mm eased edge and PVKN knife edge

media: pic

shape	dimension	model no.	PVEA		PVKN		painted edge upcharge (add -P suffix to model number)	grain match no.	grain match grade 1 list upcharge	grain match grade 2 list upcharge
			grade 1 list	grade 2 list	grade 1 list	grade 2 list				
Pic	** 48 x 72	SLPI48072PV	1,360	1,520	1,780	2,070	300	-	-	-
	** 48 x 96	SLPI48096PV	1,830	2,050	2,410	2,780	360	-	-	-
	** 60 x 156	SLPI60156PV	4,050	4,610	5,510	6,470	570	OTGRMTCH60168	570	730

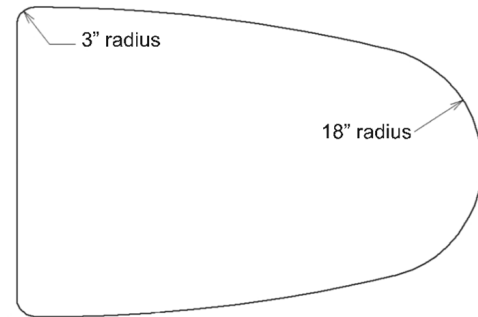

Formica + Wilsonart HPL laminate finish grades listed on pages 6-13. For additional laminate grades, contact Symphony.

\*\* 2 support bars included      2+ 2 piece top with bars + table lock set included

# surfaces

PVEA 3mm eased edge

additional shapes

shape	dimensions	model no.	PVEA	
			grade 1 list	grade 2 list
quarter round 	18 x 18	SLQR18018PVEA	180	210
	24 x 24	SLQR24024PVEA	290	330
	30 x 30	SLQR30030PVEA	420	470
half round 	18 x 36	SLHA18036PVEA	280	320
	24 x 48	SLHA24048PVEA	440	520
	30 x 60	SLHA30060PVEA	770	880
crescent 	18 x 36	SLCR18036PVEA	320	360
	24 x 48	SLCR24048PVEA	530	610
	24 x 60	SLCR24060PVEA	760	850
trapezoid 	30 x 60	SLCR30060PVEA	870	980
	24 x 48	SLTR24048PVEA	440	520
	30 x 72	SLTR30072PVEA	770	880
corner - angled front 	30 x 60	SLTR30072PVEA	930	1,060
	24 x 36	SLCA24036PVEA	480	560
	24 x 42	SLCA24042PVEA	690	800
corner - curved front 	24 x 48	SLCA24048PVEA	710	820
	24 x 36	SLCC24036PVEA	480	560
	24 x 42	SLCC24042PVEA	690	800
corner - extended curved front 	24 x 48	SLCC24048PVEA	710	820
	24 x 36 x 60	SLCE243660PVEA	880	1,000
	24 x 36 x 72	SLCE243672PVEA	1,040	1,200
	24 x 48 x 60	SLCE244860PVEA	1,140	1,320
	24 x 48 x 72	SLCE244872PVEA	1,350	1,570
	24 x 60 x 36	SLCE246036PVEA	880	1,000
	24 x 72 x 36	SLCE247236PVEA	1,040	1,200
24 x 60 x 48	SLCE246048PVEA	1,140	1,320	
corner - 120 degree 	24 x 72 x 48	SLCE247248PVEA	1,350	1,570
	24 x 36	SL1224036PVEA	1,250	1,470
	24 x 42	SL1224042PVEA	1,630	1,920
wedge 	24 x 48	SL1224048PVEA	1,680	1,970
	24 x 30 x 36	SLWE243036PVEA	420	490
	24 x 30 x 42	SLWE243042PVEA	540	630
	24 x 30 x 48	SLWE243048PVEA	550	640
	24 x 30 x 60	SLWE243060PVEA	740	840
	30 x 24 x 36	SLWE302436PVEA	420	490
	30 x 24 x 42	SLWE302442PVEA	540	630
30 x 24 x 48	SLWE302448PVEA	550	640	
	30 x 24 x 60	SLWE302460PVEA	740	840

Formica + Wilsonart HPL laminate finish grades listed on pages 6-13. For additional laminate grades, contact Symphony.



\* 1 support bar included

bases

# bases

T fixed single column sets

Keller, Ria

base	base dim.	max top support	base set qty	base set model no.	list	glides or casters	finish
	15	20 x 96	2	BTKEL20096SDGME	620	adj glides	standard metal
	20	24 x 96	2	BTKEL24096SDGME	660	adj glides	standard metal
	26	36 x 96	2	BTKEL36096SDGME	720	adj glides	standard metal
	33	42 x 96	2	BTKEL42096SDGME	890	adj glides	standard metal
	38	48 x 96	2	BTKEL48096SDGME	1,060	adj glides	standard metal
	15	20 x 96	2	BTKEL20096SDCME	700	2" black hard casters	standard metal
	20	24 x 96	2	BTKEL24096SDCME	740	2" black hard casters	standard metal
	26	36 x 96	2	BTKEL36096SDCME	800	2" black hard casters	standard metal
	33	42 x 96	2	BTKEL42096SDCME	970	2" black hard casters	standard metal
	38	48 x 96	2	BTKEL48096SDCME	1,140	2" black hard casters	standard metal
	15	20 x 96	2	BTKEL20096SDSME	820	2" black soft casters	standard metal
	20	24 x 96	2	BTKEL24096SDSME	860	2" black soft casters	standard metal
	26	36 x 96	2	BTKEL36096SDSME	920	2" black soft casters	standard metal
	33	42 x 96	2	BTKEL42096SDSME	1,090	2" black soft casters	standard metal
	38	48 x 96	2	BTKEL48096SDSME	1,260	2" black soft casters	standard metal
	15	20 x 96	2	BTKEL20096SDGPO	840	adj glides	polished
	20	24 x 96	2	BTKEL24096SDGPO	880	adj glides	polished
	26	36 x 96	2	BTKEL36096SDGPO	940	adj glides	polished
33	42 x 96	2	BTKEL42096SDGPO	1,090	adj glides	polished	
38	48 x 96	2	BTKEL48096SDGPO	1,270	adj glides	polished	
15	20 x 96	2	BTKEL20096SDCPO	920	2" black hard casters	polished	
20	24 x 96	2	BTKEL24096SDCPO	960	2" black hard casters	polished	
26	36 x 96	2	BTKEL36096SDCPO	1,020	2" black hard casters	polished	
33	42 x 96	2	BTKEL42096SDCPO	1,170	2" black hard casters	polished	
38	48 x 96	2	BTKEL48096SDCPO	1,350	2" black hard casters	polished	
15	20 x 96	2	BTKEL20096SDSPO	1,040	2" black soft casters	polished	
20	24 x 96	2	BTKEL24096SDSPO	1,080	2" black soft casters	polished	
26	36 x 96	2	BTKEL36096SDSPO	1,140	2" black soft casters	polished	
33	42 x 96	2	BTKEL42096SDSPO	1,290	2" black soft casters	polished	
38	48 x 96	2	BTKEL48096SDSPO	1,470	2" black soft casters	polished	
	15	20 x 96	2	BTRIA20096SDGME	590	adj glides	standard metal
	20	24 x 96	2	BTRIA24096SDGME	620	adj glides	standard metal
	26	36 x 96	2	BTRIA36096SDGME	670	adj glides	standard metal
	33	42 x 96	2	BTRIA42096SDGME	830	adj glides	standard metal
	38	48 x 96	2	BTRIA48096SDGME	1,010	adj glides	standard metal
	15	20 x 96	2	BTRIA20096SDCME	670	2" black hard casters	standard metal
	20	24 x 96	2	BTRIA24096SDCME	700	2" black hard casters	standard metal
	26	36 x 96	2	BTRIA36096SDCME	750	2" black hard casters	standard metal
	33	42 x 96	2	BTRIA42096SDCME	910	2" black hard casters	standard metal
	38	48 x 96	2	BTRIA48096SDCME	1,090	2" black hard casters	standard metal
	15	20 x 96	2	BTRIA20096SDSME	710	2" black soft casters	standard metal
	20	24 x 96	2	BTRIA24096SDSME	740	2" black soft casters	standard metal
	26	36 x 96	2	BTRIA36096SDSME	790	2" black soft casters	standard metal
	33	42 x 96	2	BTRIA42096SDSME	950	2" black soft casters	standard metal
	38	48 x 96	2	BTRIA48096SDSME	1,130	2" black soft casters	standard metal
	15	20 x 96	2	BTRIA20096SDGPO	780	adj glides	polished
	20	24 x 96	2	BTRIA24096SDGPO	810	adj glides	polished
	26	36 x 96	2	BTRIA36096SDGPO	870	adj glides	polished
	33	42 x 96	2	BTRIA42096SDGPO	1,020	adj glides	polished
	38	48 x 96	2	BTRIA48096SDGPO	1,210	adj glides	polished
	15	20 x 96	2	BTRIA20096SDCPO	860	2" black hard casters	polished
	20	24 x 96	2	BTRIA24096SDCPO	890	2" black hard casters	polished
	26	36 x 96	2	BTRIA36096SDCPO	950	2" black hard casters	polished
	33	42 x 96	2	BTRIA42096SDCPO	1,100	2" black hard casters	polished
	38	48 x 96	2	BTRIA48096SDCPO	1,290	2" black hard casters	polished
	15	20 x 96	2	BTRIA20096SDSPO	900	2" black soft casters	polished
	20	24 x 96	2	BTRIA24096SDSPO	930	2" black soft casters	polished
	26	36 x 96	2	BTRIA36096SDSPO	990	2" black soft casters	polished
	33	42 x 96	2	BTRIA42096SDSPO	1,140	2" black soft casters	polished
	38	48 x 96	2	BTRIA48096SDSPO	1,330	2" black soft casters	polished

**C** hard casters  
2" black dual wheel locking hard casters (for carpet)

**S** soft casters (Keller + Ria)  
2" black dual wheel locking soft casters (for hard floors)





**Standard metal powder coat finishes (ME):**  
Black Wrinkle, Chateau Brown Wrinkle, Flat Black, Furniture White, Inner Tone, Light Tone, Medium Tone, and Metallic Silver

**(PQ) Polished aluminum / chrome finish (Keller / Ria)**

# bases

T fixed single column sets

Novi, Zoey, Moto, Moto 2

base	base dim.	max top support	base set qty	base set model no.	list	glide/caster	finish	
	18	20 x 96	2	BTNOV20096SDGME	620	adj glides	standard metal	
	22	30 x 96	2	BTNOV30096SDGME	640	adj glides	standard metal	
	26	36 x 96	2	BTNOV36096SDGME	660	adj glides	standard metal	
	32	42 x 96	2	BTNOV42096SDGME	840	adj glides	standard metal	
	18	20 x 96	2	BTNOV20096SDCME	700	2" black locking casters	standard metal	
	22	30 x 96	2	BTNOV30096SDCME	730	2" black locking casters	standard metal	
	26	36 x 96	2	BTNOV36096SDCME	750	2" black locking casters	standard metal	
	32	42 x 96	2	BTNOV42096SDCME	920	2" black locking casters	standard metal	
	18	20 x 96	2	BTNOV20096SDHME	730	glides/concealed casters	standard metal	
	22	30 x 96	2	BTNOV30096SDHME	750	glides/concealed casters	standard metal	
	26	36 x 96	2	BTNOV36096SDHME	770	glides/concealed casters	standard metal	
	32	42 x 96	2	BTNOV42096SDHME	950	glides/concealed casters	standard metal	
	18	20 x 96	2	BTNOV20096SDGPC	1,000	adj glides	polished	
	22	30 x 96	2	BTNOV30096SDGPC	1,030	adj glides	polished	
	26	36 x 96	2	BTNOV36096SDGPC	1,080	adj glides	polished	
	18	20 x 96	2	BTNOV20096SDCPC	1,080	2" black locking casters	polished	
	22	30 x 96	2	BTNOV30096SDCPC	1,110	2" black locking casters	polished	
	26	36 x 96	2	BTNOV36096SDCPC	1,160	2" black locking casters	polished	
		15	20 x 96	2	BTZOE20096SDGME	570	adj glides	standard metal
		21	24 x 96	2	BTZOE24096SDGME	590	adj glides	standard metal
		27	36 x 96	2	BTZOE36096SDGME	640	adj glides	standard metal
		33	42 x 96	2	BTZOE42096SDGME	690	adj glides	standard metal
		15	20 x 96	2	BTZOE20096SDCME	660	3" black locking casters	standard metal
		21	24 x 96	2	BTZOE24096SDCME	680	3" black locking casters	standard metal
27		36 x 96	2	BTZOE36096SDCME	730	3" black locking casters	standard metal	
33		42 x 96	2	BTZOE42096SDCME	780	3" black locking casters	standard metal	
15		20 x 96	2	BTZOE20096SDPME	700	3" premium locking casters	standard metal	
21		24 x 96	2	BTZOE24096SDPME	730	3" premium locking casters	standard metal	
27		36 x 96	2	BTZOE36096SDPME	770	3" premium locking casters	standard metal	
33		42 x 96	2	BTZOE42096SDPME	830	3" premium locking casters	standard metal	
	18	24 x 96	2	BTMOT24096SDGME	780	adj glides	standard metal	
	22	30 x 96	2	BTMOT30096SDGME	840	adj glides	standard metal	
	26	36 x 96	2	BTMOT36096SDGME	890	adj glides	standard metal	
	18	24 x 96	2	BTMOT24096SDCME	870	2" black locking casters	standard metal	
	22	30 x 96	2	BTMOT30096SDCME	920	2" black locking casters	standard metal	
	26	36 x 96	2	BTMOT36096SDCME	980	2" black locking casters	standard metal	
	18	24 x 96	2	BTMOT24096SDPME	910	2" premium locking casters	standard metal	
	22	30 x 96	2	BTMOT30096SDPME	970	2" premium locking casters	standard metal	
	26	36 x 96	2	BTMOT36096SDPME	1,020	2" premium locking casters	standard metal	
	18	24 x 96	2	BTMO224096SDGME	620	adj glides	standard metal	
	22	30 x 96	2	BTMO230096SDGME	640	adj glides	standard metal	
	26	36 x 96	2	BTMO236096SDGME	690	adj glides	standard metal	
18	24 x 96	2	BTMO224096SDCME	700	2" black locking casters	standard metal		
22	30 x 96	2	BTMO230096SDCME	730	2" black locking casters	standard metal		
26	36 x 96	2	BTMO236096SDCME	780	2" black locking casters	standard metal		
18	24 x 96	2	BTMO224096SDPME	750	2" premium locking casters	standard metal		
22	30 x 96	2	BTMO230096SDPME	770	2" premium locking casters	standard metal		
26	36 x 96	2	BTMO236096SDPME	830	2" premium locking casters	standard metal		

**C** casters  
2" black dual wheel locking (all bases except Zoey)  
3" black dual wheel locking (Zoey)

**P** premium casters  
3" white dual wheel locking (Zoey)  
2" silver/black dual wheel locking - (Moto, Moto 2)

**H** Novi hidden/concealed casters  
one T base per set has glides, the other base has hidden/concealed casters

**Standard metal powder coat finishes (ME):**  
Black Wrinkle, Chateau Brown Wrinkle, Flat Black, Furniture White, Inner Tone, Light Tone, Medium Tone, and Metallic Silver

**(PC) Polished chrome finish (Rosanno / Novi)**

**Note that the fixed T bases cannot be spread more than 50" apart at center.**





**Custom height bases for Keller, Ria, Moto, and Novi only - + \$150 list**  
Custom lower and taller fixed height options are available for **single column** tables with a top size up to 36 x 72.  
For a custom lower height, replace the "SD" in the model number for "SL"  
For a custom taller fixed height, replace the "SD" in the model number for "SH"

**Note that the fixed T bases cannot be spread more than 50" apart at center.**



# bases

Keller, Ria, Novi, Moto, Zoey TT fixed  
Novi double column nesting

base	base dim.	max top support	base set qty	base set model no.	list	glides	finish
	34	48 x 96	2	BTKEL480962DGME	1,180	adj glides	standard metal
	34	48 x 144	3	BTKEL481442DGME	1,770	adj glides	standard metal
	34	48 x 192	4	BTKEL481922DGME	2,360	adj glides	standard metal
	40	60 x 96	2	BTKEL600962DGME	1,280	adj glides	standard metal
	40	60 x 144	3	BTKEL601442DGME	1,920	adj glides	standard metal
	40	60 x 192	4	BTKEL601922DGME	2,560	adj glides	standard metal
	34	48 x 96	2	BTKEL480962DGPO	1,590	adj glides	polished
	34	48 x 144	3	BTKEL481442DGPO	2,400	adj glides	polished
	34	48 x 192	4	BTKEL481922DGPO	3,190	adj glides	polished
	40	60 x 96	2	BTKEL600962DGPO	1,700	adj glides	polished
	40	60 x 144	3	BTKEL601442DGPO	2,540	adj glides	polished
	40	60 x 192	4	BTKEL601922DGPO	3,400	adj glides	polished
	34	48 x 96	2	BTRIA480962DGME	1,110	adj glides	standard metal
	34	48 x 144	3	BTRIA481442DGME	1,660	adj glides	standard metal
	34	48 x 192	4	BTRIA481922DGME	2,220	adj glides	standard metal
	40	60 x 96	2	BTRIA600962DGME	1,170	adj glides	standard metal
	40	60 x 144	3	BTRIA601442DGME	1,740	adj glides	standard metal
	40	60 x 192	4	BTRIA601922DGME	2,340	adj glides	standard metal
	34	48 x 96	2	BTRIA480962DGPO	1,510	adj glides	polished
	34	48 x 144	3	BTRIA481442DGPO	2,270	adj glides	polished
	34	48 x 192	4	BTRIA481922DGPO	3,020	adj glides	polished
	40	60 x 96	2	BTRIA600962DGPO	1,570	adj glides	polished
	40	60 x 144	3	BTRIA601442DGPO	2,350	adj glides	polished
	40	60 x 192	4	BTRIA601922DGPO	3,150	adj glides	polished
	36	48 x 96	2	BTNOV480962DGME	1,050	adj glides	standard metal
	36	48 x 144	3	BTNOV481442DGME	1,570	adj glides	standard metal
	42	60 x 96	2	BTNOV600962DGME	1,120	adj glides	standard metal
	42	60 x 144	3	BTNOV601442DGME	1,670	adj glides	standard metal
	26	36 x 96	2	BTMOT360962DGME	1,250	adj glides	standard metal
	26	36 x 144	3	BTMOT361442DGME	1,890	adj glides	standard metal
	32	42 x 96	2	BTMOT420962DGME	1,330	adj glides	standard metal
	32	42 x 144	3	BTMOT421442DGME	1,990	adj glides	standard metal
	32	42 x 192	4	BTMOT421922DGME	2,660	adj glides	standard metal
	36	48 x 96	2	BTMOT480962DGME	1,430	adj glides	standard metal
	36	48 x 144	3	BTMOT481442DGME	2,130	adj glides	standard metal
	36	48 x 192	4	BTMOT481922DGME	2,850	adj glides	standard metal
		38	48 x 96	2	BTZOE480962DGME	1,310	adj glides
38		48 x 144	3	BTZOE481442DGME	1,960	adj glides	standard metal
38		48 x 192	4	BTZOE481922DGME	2,620	adj glides	standard metal
47		60 x 96	2	BTZOE600962DGME	1,430	adj glides	standard metal
47		60 x 144	3	BTZOE601442DGME	2,130	adj glides	standard metal
47		60 x 192	4	BTZOE601922DGME	2,850	adj glides	standard metal

\*Note that fixed double column T bases cannot be spread more than 50" apart at center.

Novi Double Column with Nester Series beam	32	48 x 48, 60rd	2	BTNOV480482NCME	2,210	3" black locking casters	standard metal
--	----	---------------	---	-----------------	-------	--------------------------	----------------







**Standard metal powder coat finishes (ME):**  
Black Wrinkle, Chateau Brown Wrinkle, Flat Black, Furniture White, Inner Tone, Light Tone, Medium Tone, and Metallic Silver

**(PQ) Polished aluminum / chrome finish (Keller / Ria)**

**(PC) Polished chrome finish (Rosanno / Novi)**

# bases

T nesting sets  
Keller, Ria, Novi

base	base dim.	max top support	base set qty	base set model no.	list	glides or casters	finish
	15	20 x 72	2	BTKEL20072NEGME	1,060	adj glides	standard metal
	20	24 x 72	2	BTKEL24072NEGME	1,110	adj glides	standard metal
	26	36 x 72	2	BTKEL36072NEGME	1,160	adj glides	standard metal
	15	20 x 72	2	BTKEL20072NECME	1,140	2" black hard casters	standard metal
	20	24 x 72	2	BTKEL24072NECME	1,190	2" black hard casters	standard metal
	26	36 x 72	2	BTKEL36072NECME	1,240	2" black hard casters	standard metal
	15	20 x 72	2	BTKEL20072NESME	1,180	2" black soft casters	standard metal
	20	24 x 72	2	BTKEL24072NESME	1,230	2" black soft casters	standard metal
	26	36 x 72	2	BTKEL36072NESME	1,280	2" black soft casters	standard metal
	15	20 x 72	2	BTKEL20072NEGPO	1,280	adj glides	polished
	20	24 x 72	2	BTKEL24072NEGPO	1,320	adj glides	polished
	26	36 x 72	2	BTKEL36072NEGPO	1,380	adj glides	polished
	15	20 x 72	2	BTKEL20072NECPO	1,360	2" black hard casters	polished
	20	24 x 72	2	BTKEL24072NECPO	1,400	2" black hard casters	polished
	26	36 x 72	2	BTKEL36072NECPO	1,460	2" black hard casters	polished
	15	20 x 72	2	BTKEL20072NESPO	1,400	2" black soft casters	polished
	20	24 x 72	2	BTKEL24072NESPO	1,440	2" black soft casters	polished
	26	36 x 72	2	BTKEL36072NESPO	1,500	2" black soft casters	polished
	15	20 x 72	2	BTRIA20072NEGME	1,030	adj glides	standard metal
	20	24 x 72	2	BTRIA24072NEGME	1,070	adj glides	standard metal
	26	36 x 72	2	BTRIA36072NEGME	1,140	adj glides	standard metal
	15	20 x 72	2	BTRIA20072NECME	1,110	2" black hard casters	standard metal
	20	24 x 72	2	BTRIA24072NECME	1,150	2" black hard casters	standard metal
	26	36 x 72	2	BTRIA36072NECME	1,220	2" black hard casters	standard metal
	15	20 x 72	2	BTRIA20072NESME	1,150	2" black soft casters	standard metal
	20	24 x 72	2	BTRIA24072NESME	1,190	2" black soft casters	standard metal
	26	36 x 72	2	BTRIA36072NESME	1,260	2" black soft casters	standard metal
	15	20 x 72	2	BTRIA20072NEGPO	1,220	adj glides	polished
	20	24 x 72	2	BTRIA24072NEGPO	1,250	adj glides	polished
	26	36 x 72	2	BTRIA36072NEGPO	1,310	adj glides	polished
	15	20 x 72	2	BTRIA20072NECPO	1,300	2" black hard casters	polished
	20	24 x 72	2	BTRIA24072NECPO	1,330	2" black hard casters	polished
	26	36 x 72	2	BTRIA36072NECPO	1,390	2" black hard casters	polished
	15	20 x 72	2	BTRIA20072NESPO	1,340	2" black soft casters	polished
	20	24 x 72	2	BTRIA24072NESPO	1,370	2" black soft casters	polished
	26	36 x 72	2	BTRIA36072NESPO	1,430	2" black soft casters	polished
	18	20 x 72	2	BTNOV20072NEGME	1,130	adj glides	standard metal
	22	30 x 72	2	BTNOV30072NEGME	1,140	adj glides	standard metal
	26	36 x 72	2	BTNOV36072NEGME	1,180	adj glides	standard metal
	18	20 x 72	2	BTNOV20072NECME	1,220	2" black locking casters	standard metal
	22	30 x 72	2	BTNOV30072NECME	1,230	2" black locking casters	standard metal
	26	36 x 72	2	BTNOV36072NECME	1,270	2" black locking casters	standard metal
	18	20 x 72	2	BTNOV20072NEHME	1,240	glides/concealed casters	standard metal
	22	30 x 72	2	BTNOV30072NEHME	1,250	glides/concealed casters	standard metal
	26	36 x 72	2	BTNOV36072NEHME	1,290	glides/concealed casters	standard metal

**C casters**  
2" black dual wheel locking hard casters (single column flip/nest bases)



**S casters (Keller + Ria)**  
2" black dual wheel locking soft casters (for hard floors)



**H Novi hidden/concealed casters**  
one T base per set has glides, the other base has hidden/concealed casters

**Standard metal powder coat finishes (ME):**  
Black Wrinkle, Chateau Brown Wrinkle, Flat Black, Furniture White, Inner Tone, Light Tone, Medium Tone, and Metallic Silver

**(PQ) Polished aluminum / chrome finish (Keller / Ria)**

KELLER, RIA, AND NOVI SINGLE T FLIP MECH  
IMAGE:



\*bases cannot be spread more than 50" apart at center

# bases

## T nesting sets

### Zoey

base	base dim.	max top support	base set qty	base set model no.	list	glides or casters	finish
Zoey with beam	15	20 x 60	2	BTZOE20060NBGM	1,240	adj glides	standard metal
	21	24 x 60	2	BTZOE24060NBGM	1,280	adj glides	standard metal
	27	30 x 60	2	BTZOE30060NBGM	1,300	adj glides	standard metal
	33	36 x 60	2	BTZOE36060NBGM	1,340	adj glides	standard metal
	15	20 x 72	2	BTZOE20072NBGM	1,290	adj glides	standard metal
	21	24 x 72	2	BTZOE24072NBGM	1,310	adj glides	standard metal
	27	30 x 72	2	BTZOE30072NBGM	1,330	adj glides	standard metal
	33	36 x 72	2	BTZOE36072NBGM	1,390	adj glides	standard metal
	15	20 x 60	2	BTZOE20060NBCM	1,320	3" black locking casters	standard metal
	21	24 x 60	2	BTZOE24060NBCM	1,360	3" black locking casters	standard metal
	27	30 x 60	2	BTZOE30060NBCM	1,380	3" black locking casters	standard metal
	33	36 x 60	2	BTZOE36060NBCM	1,420	3" black locking casters	standard metal
15	20 x 72	2	BTZOE20072NBCM	1,370	3" black locking casters	standard metal	
21	24 x 72	2	BTZOE24072NBCM	1,390	3" black locking casters	standard metal	
27	30 x 72	2	BTZOE30072NBCM	1,410	3" black locking casters	standard metal	
33	36 x 72	2	BTZOE36072NBCM	1,470	3" black locking casters	standard metal	
15	20 x 60	2	BTZOE20060NBPME	1,360	3" premium locking casters	standard metal	
21	24 x 60	2	BTZOE24060NBPME	1,400	3" premium locking casters	standard metal	
27	30 x 60	2	BTZOE30060NBPME	1,420	3" premium locking casters	standard metal	
33	36 x 60	2	BTZOE36060NBPME	1,460	3" premium locking casters	standard metal	
15	20 x 72	2	BTZOE20072NBPME	1,410	3" premium locking casters	standard metal	
21	24 x 72	2	BTZOE24072NBPME	1,430	3" premium locking casters	standard metal	
27	30 x 72	2	BTZOE30072NBPME	1,450	3" premium locking casters	standard metal	
33	36 x 72	2	BTZOE36072NBPME	1,510	3" premium locking casters	standard metal	
Zoey without beam	15	20 x 72	2	BTZOE20072NEGME	1,130	adj glides	standard metal
	21	24 x 60	2	BTZOE24072NEGME	1,170	adj glides	standard metal
	27	30 x 72	2	BTZOE30072NEGME	1,220	adj glides	standard metal
	15	20 x 72	2	BTZOE20072NECME	1,210	3" black locking casters	standard metal
	21	24 x 60	2	BTZOE24072NECME	1,250	3" black locking casters	standard metal
	27	30 x 72	2	BTZOE30072NECME	1,300	3" black locking casters	standard metal
	15	20 x 72	2	BTZOE20072NEPME	1,250	3" premium locking casters	standard metal
	21	24 x 60	2	BTZOE24072NEPME	1,290	3" premium locking casters	standard metal
	27	30 x 72	2	BTZOE30072NEPME	1,340	3" premium locking casters	standard metal

**C casters**  
3" black dual wheel locking

**P premium casters**  
3" white dual wheel locking

**Standard metal powder coat finishes (ME):**  
Black Wrinkle, Chateau Brown Wrinkle, Flat Black, Furniture White, Inner Tone, Light Tone, Medium Tone, and Metallic Silver

#### Zoey flip nest bases with a beam do not require top stiffeners

The cost of the top stiffener is included in the standard Symphony top price.

Deduct the following from the list price shown for a top in the top section of the price list

-\$70 list for tops that are up to 24" deep x 60 long (1 stiffener)

-\$90 list for tops that are up to 24" deep x 72 long (1 stiffener)

-\$140 list for tops that are up to 30-36" deep x 60 long (2 stiffeners)

-\$170 list for tops that are up to 30-36" deep x 72 long (2 stiffeners)

Note that the "NE" model numbers do not have a beam and therefore the bases cannot be spread more than 50" apart at center when using top stiffeners.

# bases

## T nesting sets

### Moto 2

base	base dim.	max top support	base set qty	base set model no.	list	glide/caster	finish
Moto 2 (2" column) with beam	18	24 x 60	2	BTMO224060NBGM	1,380	adj glides	standard metal
	22	30 x 60	2	BTMO230060NBGM	1,390	adj glides	standard metal
	26	36 x 60	2	BTMO236060NBGM	1,450	adj glides	standard metal
	18	24 x 72	2	BTMO224072NBGM	1,420	adj glides	standard metal
	22	30 x 72	2	BTMO230072NBGM	1,430	adj glides	standard metal
	26	36 x 72	2	BTMO236072NBGM	1,490	adj glides	standard metal
	18	24 x 60	2	BTMO224060NBCM	1,460	2" black locking casters	standard metal
	22	30 x 60	2	BTMO230060NBCM	1,470	2" black locking casters	standard metal
	26	36 x 60	2	BTMO236060NBCM	1,540	2" black locking casters	standard metal
	18	24 x 72	2	BTMO224072NBCM	1,510	2" black locking casters	standard metal
	22	30 x 72	2	BTMO230072NBCM	1,520	2" black locking casters	standard metal
	26	36 x 72	2	BTMO236072NBCM	1,570	2" black locking casters	standard metal
18	24 x 60	2	BTMO224060NBPME	1,510	2" premium locking casters	standard metal	
22	30 x 60	2	BTMO230060NBPME	1,520	2" premium locking casters	standard metal	
26	36 x 60	2	BTMO236060NBPME	1,580	2" premium locking casters	standard metal	
18	24 x 72	2	BTMO224072NBPME	1,550	2" premium locking casters	standard metal	
22	30 x 72	2	BTMO230072NBPME	1,560	2" premium locking casters	standard metal	
26	36 x 72	2	BTMO236072NBPME	1,620	2" premium locking casters	standard metal	
Moto 2 (2" column) without beam	18	24 x 72	2	BTMO224072NEGME	1,210	adj glides	standard metal
	22	30 x 72	2	BTMO230072NEGME	1,230	adj glides	standard metal
	18	24 x 72	2	BTMO224072NECME	1,300	2" black locking casters	standard metal
	22	30 x 72	2	BTMO230072NECME	1,320	2" black locking casters	standard metal
	18	24 x 72	2	BTMO224072NEPME	1,340	2" premium locking casters	standard metal
	22	30 x 72	2	BTMO230072NEPME	1,360	2" premium locking casters	standard metal

**C casters**  
2" black dual wheel locking

**P premium casters**  
2" silver/black dual wheel locking

**Standard metal powder coat finishes (ME):**  
Black Wrinkle, Chateau Brown Wrinkle, Flat Black, Furniture White, Inner Tone, Light Tone, Medium Tone, and Metallic Silver

#### Moto flip nest bases with a beam do not require top stiffeners

The cost of the top stiffener is included in the standard Symphony top price.

Deduct the following from the list price shown for a top in the top section of the price list

-\$70 list for tops that are 18-24" deep x 60 long (1 stiffener)

-\$90 list for tops that are 18-24" deep x 72 long (1 stiffener)

-\$140 list for tops that are 30-36" deep x 60 long (2 stiffeners)



-\$170 list for tops that are 30-36" deep x 72 long (2 stiffeners)

Note that the "NE" model numbers do not have a beam and therefore the bases cannot be spread more than 50" apart at center when using top stiffeners.

# bases

## T nesting adjustable height sets

Keller, Ria, Novi

base	base dim.	max top support	base set qty	base set model no.	list	glides or casters	finish	
Keller 	nesting/spring clip	15	20 x 72	2	BTKEL20072NSGME	1,360	adj glides	standard metal
		20	24 x 72	2	BTKEL24072NSGME	1,400	adj glides	standard metal
		26	36 x 72	2	BTKEL36072NSGME	1,460	adj glides	standard metal
		15	20 x 72	2	BTKEL20072NSCME	1,440	2" black hard casters	standard metal
		20	24 x 72	2	BTKEL24072NSCME	1,480	2" black hard casters	standard metal
		26	36 x 72	2	BTKEL36072NSCME	1,540	2" black hard casters	standard metal
		15	20 x 72	2	BTKEL20072NSSME	1,480	2" black soft casters	standard metal
		20	24 x 72	2	BTKEL24072NSSME	1,520	2" black soft casters	standard metal
		26	36 x 72	2	BTKEL36072NSSME	1,580	2" black soft casters	standard metal
Ria 	nesting/spring clip	15	20 x 72	2	BTRIA20072NSGME	1,320	adj glides	standard metal
		20	24 x 72	2	BTRIA24072NSGME	1,350	adj glides	standard metal
		26	36 x 72	2	BTRIA36072NSGME	1,410	adj glides	standard metal
		15	20 x 72	2	BTRIA20072NSCME	1,400	2" black hard casters	standard metal
		20	24 x 72	2	BTRIA24072NSCME	1,430	2" black hard casters	standard metal
		26	36 x 72	2	BTRIA36072NSCME	1,490	2" black hard casters	standard metal
		15	20 x 72	2	BTRIA20072NSSME	1,440	2" black soft casters	standard metal
		20	24 x 72	2	BTRIA24072NSSME	1,470	2" black soft casters	standard metal
		26	36 x 72	2	BTRIA36072NSSME	1,530	2" black soft casters	standard metal
Novi 	nesting/spring clip	18	20 x 72	2	BTNOV20072NSGME	1,450	adj glides	standard metal
		22	30 x 72	2	BTNOV30072NSGME	1,460	adj glides	standard metal
		26	36 x 72	2	BTNOV36072NSGME	1,500	adj glides	standard metal
		18	20 x 72	2	BTNOV20072NSCME	1,540	2" black locking casters	standard metal
		22	30 x 72	2	BTNOV30072NSCME	1,550	2" black locking casters	standard metal
		26	36 x 72	2	BTNOV36072NSCME	1,580	2" black locking casters	standard metal
		18	20 x 72	2	BTNOV20072NSHME	1,560	glides/concealed casters	standard metal
		22	30 x 72	2	BTNOV30072NSHME	1,570	glides/concealed casters	standard metal
		26	36 x 72	2	BTNOV36072NSHME	1,610	glides/concealed casters	standard metal

**C casters**  
2" black dual wheel locking hard casters (for carpet)

**S casters (Keller + Ria)**  
2" black dual wheel locking soft casters (for hard floors)

**H Novi hidden/concealed casters**  
one T base per set has glides, the other base has hidden/concealed casters

**Standard metal powder coat finishes (ME)**  
Black Wrinkle, Chateau Brown Wrinkle, Flat Black, Furniture White, Inner Tone, Light Tone, Medium Tone, and Metallic Silver

\*\* Note that the inner column of Moto height adjustable bases are only available in Flat Black, White or Metallic Silver. Note that Moto White is a shade off and a little creamier than Furniture White. The Moto height adjustable bases inner and outer columns are only available in Flat Black, Moto White and Metallic Silver.

**S Spring clip height adjustment**  
24.75" - 33.75" (Keller, Ria, and Novi)  
range in 1" increments

# bases

## T nesting adjustable height sets

Moto

base	base dim.	max top support	base placement with beam	base set qty	base set model no.	list	glides or casters	finish
Moto nesting/crank retractable handle 3" column 	18	24 x 48	30" O.C.	2	BTMOT24048NCGME	2,190	adj glides	standard metal
	18	24 x 54	36" O.C.	2	BTMOT24054NCGME	2,190	adj glides	standard metal
	18	24 x 60	42" O.C.	2	BTMOT24060NCGME	2,190	adj glides	standard metal
	18	24 x 66	48" O.C.	2	BTMOT24066NCGME	2,190	adj glides	standard metal
	18	24 x 72	54" O.C.	2	BTMOT24072NCGME	2,190	adj glides	standard metal
	22	30 x 48	30" O.C.	2	BTMOT30048NCGME	2,220	adj glides	standard metal
	22	30 x 54	36" O.C.	2	BTMOT30054NCGME	2,220	adj glides	standard metal
	22	30 x 60	42" O.C.	2	BTMOT30060NCGME	2,220	adj glides	standard metal
	22	30 x 66	48" O.C.	2	BTMOT30066NCGME	2,220	adj glides	standard metal
	22	30 x 72	54" O.C.	2	BTMOT30072NCGME	2,220	adj glides	standard metal
	26	36 x 48	30" O.C.	2	BTMOT36048NCGME	2,240	adj glides	standard metal
	26	36 x 54	36" O.C.	2	BTMOT36054NCGME	2,240	adj glides	standard metal
	26	36 x 60	42" O.C.	2	BTMOT36060NCGME	2,240	adj glides	standard metal
	26	36 x 66	48" O.C.	2	BTMOT36066NCGME	2,240	adj glides	standard metal
	26	36 x 72	54" O.C.	2	BTMOT36072NCGME	2,240	adj glides	standard metal
	18	24 x 48	30" O.C.	2	BTMOT24048NCCME	2,310	2" black locking casters	standard metal
	18	24 x 54	36" O.C.	2	BTMOT24054NCCME	2,310	2" black locking casters	standard metal
	18	24 x 60	42" O.C.	2	BTMOT24060NCCME	2,310	2" black locking casters	standard metal
	18	24 x 66	48" O.C.	2	BTMOT24066NCCME	2,310	2" black locking casters	standard metal
	18	24 x 72	54" O.C.	2	BTMOT24072NCCME	2,310	2" black locking casters	standard metal
	22	30 x 48	30" O.C.	2	BTMOT30048NCCME	2,330	2" black locking casters	standard metal
	22	30 x 54	36" O.C.	2	BTMOT30054NCCME	2,330	2" black locking casters	standard metal
	22	30 x 60	42" O.C.	2	BTMOT30060NCCME	2,330	2" black locking casters	standard metal
	22	30 x 66	48" O.C.	2	BTMOT30066NCCME	2,330	2" black locking casters	standard metal
22	30 x 72	54" O.C.	2	BTMOT30072NCCME	2,330	2" black locking casters	standard metal	
26	36 x 48	30" O.C.	2	BTMOT36048NCCME	2,350	2" black locking casters	standard metal	
26	36 x 54	36" O.C.	2	BTMOT36054NCCME	2,350	2" black locking casters	standard metal	
26	36 x 60	42" O.C.	2	BTMOT36060NCCME	2,350	2" black locking casters	standard metal	
26	36 x 66	48" O.C.	2	BTMOT36066NCCME	2,350	2" black locking casters	standard metal	
26	36 x 72	54" O.C.	2	BTMOT36072NCCME	2,350	2" black locking casters	standard metal	
18	24 x 48	30" O.C.	2	BTMOT24048NCPME	2,340	2" premium locking casters	standard metal	
18	24 x 54	36" O.C.	2	BTMOT24054NCPME	2,340	2" premium locking casters	standard metal	
18	24 x 60	42" O.C.	2	BTMOT24060NCPME	2,340	2" premium locking casters	standard metal	
18	24 x 66	48" O.C.	2	BTMOT24066NCPME	2,340	2" premium locking casters	standard metal	
18	24 x 72	54" O.C.	2	BTMOT24072NCPME	2,340	2" premium locking casters	standard metal	
22	30 x 48	30" O.C.	2	BTMOT30072NCPME	2,360	2" premium locking casters	standard metal	
22	30 x 54	36" O.C.	2	BTMOT30072NCPME	2,360	2" premium locking casters	standard metal	
22	30 x 60	42" O.C.	2	BTMOT30072NCPME	2,360	2" premium locking casters	standard metal	
22	30 x 66	48" O.C.	2	BTMOT30072NCPME	2,360	2" premium locking casters	standard metal	
22	30 x 72	54" O.C.	2	BTMOT30072NCPME	2,360	2" premium locking casters	standard metal	
26	36 x 72	30" O.C.	2	BTMOT36072NCPME	2,380	2" premium locking casters	standard metal	
26	36 x 72	36" O.C.	2	BTMOT36072NCPME	2,380	2" premium locking casters	standard metal	
26	36 x 72	42" O.C.	2	BTMOT36072NCPME	2,380	2" premium locking casters	standard metal	
26	36 x 72	48" O.C.	2	BTMOT36072NCPME	2,380	2" premium locking casters	standard metal	
26	36 x 72	54" O.C.	2	BTMOT36072NCPME	2,380	2" premium locking casters	standard metal	

**C casters**  
2" black dual wheel locking casters

**P premium casters (Moto)**  
2" black/silver dual wheel locking

**NC nesting crank height adjustment (Moto)**  
retractable handle  
24" - 38" height range with glides  
26" - 40" height range with casters  
Columns inset 9" on center from edge of table top.



**Standard metal powder coat finishes (ME)**  
Black Wrinkle, Chateau Brown Wrinkle, Flat Black, Furniture White, Inner Tone, Light Tone, Medium Tone, and Metallic Silver

\*\* Note that the inner column of Moto height adjustable bases are only available in Flat Black, White or Metallic Silver. Note that Moto White is a shade off and a little creamier than Furniture White. The Moto height adjustable bases inner and outer columns are only available in Flat Black, Moto White and Metallic Silver.

# bases

T adjustable height sets

Keller, Ria, Novi

base	base dim.	max top support	base set qty	base set model no.	list	glides or casters	finish		
Keller 	spring clip	15	20 x 72	2	BTKEL20072SSGME	920	adj glides	standard metal	
		20	24 x 72	2	BTKEL24072SSGME	960	adj glides	standard metal	
		26	36 x 72	2	BTKEL36072SSGME	1,020	adj glides	standard metal	
		33	42 x 72	2	BTKEL42072SSGME	1,190	adj glides	standard metal	
	2" black hard casters	15	20 x 72	2	BTKEL20072SSCME	1,000	2" black hard casters	standard metal	
		20	24 x 72	2	BTKEL24072SSCME	1,040	2" black hard casters	standard metal	
		26	36 x 72	2	BTKEL36072SSCME	1,100	2" black hard casters	standard metal	
		33	42 x 72	2	BTKEL42072SSCME	1,270	2" black hard casters	standard metal	
		2" black soft casters	15	20 x 72	2	BTKEL20072SSSME	1,040	2" black soft casters	standard metal
			20	24 x 72	2	BTKEL24072SSSME	1,080	2" black soft casters	standard metal
	26		36 x 72	2	BTKEL36072SSSME	1,140	2" black soft casters	standard metal	
	33		42 x 72	2	BTKEL42072SSSME	1,310	2" black soft casters	standard metal	
	Ria 	spring clip	15	20 x 72	2	BTRIA20072SSGME	890	adj glides	standard metal
			20	24 x 72	2	BTRIA24072SSGME	910	adj glides	standard metal
26			36 x 72	2	BTRIA36072SSGME	970	adj glides	standard metal	
33			42 x 72	2	BTRIA42072SSGME	1,130	adj glides	standard metal	
2" black hard casters		15	20 x 72	2	BTRIA20072SSCME	970	2" black hard casters	standard metal	
		20	24 x 72	2	BTRIA24072SSCME	990	2" black hard casters	standard metal	
		26	36 x 72	2	BTRIA36072SSCME	1,050	2" black hard casters	standard metal	
		33	42 x 72	2	BTRIA42072SSCME	1,210	2" black hard casters	standard metal	
		2" black soft casters	15	20 x 72	2	BTRIA20072SSSME	1,010	2" black soft casters	standard metal
			20	24 x 72	2	BTRIA24072SSSME	1,030	2" black soft casters	standard metal
26			36 x 72	2	BTRIA36072SSSME	1,090	2" black soft casters	standard metal	
33			42 x 72	2	BTRIA42072SSSME	1,250	2" black soft casters	standard metal	
Novi 		spring clip	18	20 x 72	2	BTNOV20072SSGME	960	adj glides	standard metal
			22	30 x 72	2	BTNOV30072SSGME	990	adj glides	standard metal
	26		36 x 72	2	BTNOV36072SSGME	1,010	adj glides	standard metal	
	32		42 x 72	2	BTNOV42072SSGME	1,200	adj glides	standard metal	
	2" black locking casters	18	20 x 72	2	BTNOV20072SSCME	1,050	2" black locking casters	standard metal	
		22	30 x 72	2	BTNOV30072SSCME	1,080	2" black locking casters	standard metal	
		26	36 x 72	2	BTNOV36072SSCME	1,100	2" black locking casters	standard metal	
		32	42 x 72	2	BTNOV42072SSCME	1,290	2" black locking casters	standard metal	
	glides/concealed casters	18	20 x 72	2	BTNOV20072SSHME	1,070	glides/concealed casters	standard metal	
		22	30 x 72	2	BTNOV30072SSHME	1,100	glides/concealed casters	standard metal	
		26	36 x 72	2	BTNOV36072SSHME	1,120	glides/concealed casters	standard metal	
		32	42 x 72	2	BTNOV42072SSHME	1,310	glides/concealed casters	standard metal	
	ratchet	18	24 x 72	2	BTNOV24072SRGME	1,620	adj glides	standard metal	
		22	30 x 72	2	BTNOV30072SRGME	1,650	adj glides	standard metal	
26		36 x 72	2	BTNOV36072SRGME	1,670	adj glides	standard metal		
18		24 x 72	2	BTNOV24072SRCME	1,700	2" black locking casters	standard metal		
22	30 x 72	2	BTNOV30072SRCME	1,730	2" black locking casters	standard metal			
26	36 x 72	2	BTNOV36072SRCME	1,750	2" black locking casters	standard metal			

**C casters**  
2" black dual wheel locking hard casters (for carpet)

**S casters (Keller + Ria)**  
2" black dual wheel locking soft casters (for hard floors)

**S Spring clip height adjustment**  
24.75" - 33.75" (Keller, Ria, Rosanno, and Novi)  
range in 1" increments

**Standard metal powder coat finishes (ME)**  
Black Wrinkle, Chateau Brown Wrinkle, Flat Black, Furniture White, Inner Tone, Light Tone, Medium Tone, and Metallic Silver

**R Ratchet height adjustment (Novi)**  
can be combined with flip top and casters  
27.75" - 39.75" height range with glides, casters add 2" to the height of the base  
easy adjustment: set foot on base and lift surface  
to lower, lift to highest level for release down to lowest position

# bases

## T adjustable height sets

### Moto

base	base dim.	max top support	base set qty	base set model no.	list	glides or casters	finish	
<b>Moto (3" column)</b>								
	ratchet	18	24 x 72	2	BTMOT24072SRGME	1,170	adj glides	standard metal
		22	30 x 72	2	BTMOT30072SRGME	1,190	adj glides	standard metal
		26	36 x 72	2	BTMOT36072SRGME	1,230	adj glides	standard metal
	extended range crank	18	24 x 72	2	BTMOT24072SRCME	1,250	2" black locking casters	standard metal
		22	30 x 72	2	BTMOT30072SRCME	1,280	2" black locking casters	standard metal
		26	36 x 72	2	BTMOT36072SRCME	1,320	2" black locking casters	standard metal
		18	24 x 72	2	BTMOT24072SRPME	1,300	2" premium locking casters	standard metal
		22	30 x 72	2	BTMOT30072SRPME	1,320	2" premium locking casters	standard metal
		26	36 x 72	2	BTMOT36072SRPME	1,360	2" premium locking casters	standard metal
middle range crank	extended range crank	18	24 x 72	2	BTMOT24072SCEGME	1,530	adj glides	standard metal
		22	30 x 72	2	BTMOT30072SCEGME	1,540	adj glides	standard metal
		26	36 x 72	2	BTMOT36072SCEGME	1,600	adj glides	standard metal
	middle range crank	18	24 x 72	2	BTMOT24072SCECME	1,620	2" black locking casters	standard metal
		22	30 x 72	2	BTMOT30072SCECME	1,630	2" black locking casters	standard metal
		26	36 x 72	2	BTMOT36072SCECME	1,680	2" black locking casters	standard metal
		18	24 x 72	2	BTMOT24072SCEPME	1,660	2" premium locking casters	standard metal
		22	30 x 72	2	BTMOT30072SCEPME	1,670	2" premium locking casters	standard metal
		26	36 x 72	2	BTMOT36072SCEPME	1,730	2" premium locking casters	standard metal
short range crank	middle range crank	18	24 x 72	2	BTMOT24072SCMGME	1,530	adj glides	standard metal
		22	30 x 72	2	BTMOT30072SCMGME	1,540	adj glides	standard metal
		26	36 x 72	2	BTMOT36072SCMGME	1,600	adj glides	standard metal
	short range crank	18	24 x 72	2	BTMOT24072SCMCME	1,620	2" black locking casters	standard metal
		22	30 x 72	2	BTMOT30072SCMCME	1,630	2" black locking casters	standard metal
		26	36 x 72	2	BTMOT36072SCMCME	1,680	2" black locking casters	standard metal
		18	24 x 72	2	BTMOT24072SCMPME	1,660	2" premium locking casters	standard metal
		22	30 x 72	2	BTMOT30072SCMPME	1,670	2" premium locking casters	standard metal
		26	36 x 72	2	BTMOT36072SCMPME	1,730	2" premium locking casters	standard metal
NSI/BIFMA electric 2-stage basic switch	short range crank	18	24 x 72	2	BTMOT24072SCSGME	1,530	adj glides	standard metal
		22	30 x 72	2	BTMOT30072SCSGME	1,540	adj glides	standard metal
		26	36 x 72	2	BTMOT36072SCSGME	1,600	adj glides	standard metal
	NSI/BIFMA electric 2-stage basic switch	18	24 x 72	2	BTMOT24072SCSCME	1,620	2" black locking casters	standard metal
		22	30 x 72	2	BTMOT30072SCSCME	1,630	2" black locking casters	standard metal
		26	36 x 72	2	BTMOT36072SCSCME	1,680	2" black locking casters	standard metal
		18	24 x 72	2	BTMOT24072SCSPME	1,660	2" premium locking casters	standard metal
		22	30 x 72	2	BTMOT30072SCSPME	1,670	2" premium locking casters	standard metal
		26	36 x 72	2	BTMOT36072SCSPME	1,730	2" premium locking casters	standard metal
programmable switch	18	24 x 72	2	BTMO324072SPGME	3,360	adj glides	standard metal	
	22	30 x 72	2	BTMO330072SPGME	3,380	adj glides	standard metal	
	26	36 x 72	2	BTMO336072SPGME	3,400	adj glides	standard metal	

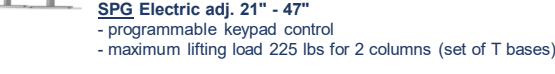
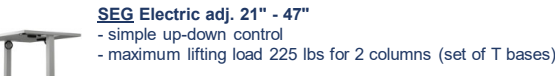
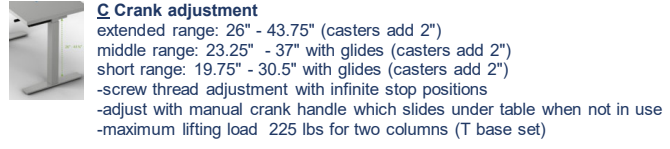
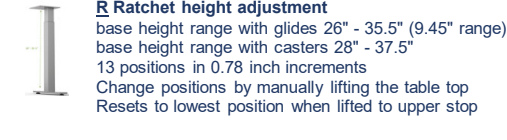
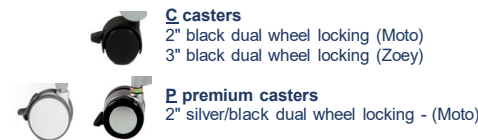

**Standard metal powder coat finishes (ME)**  
Flat Black, Furniture White, Inner Tone, Light Tone, Medium Tone, and Metallic Silver

**\*\* Note that the inner column of Moto height adjustable bases are only available in Flat Black, White or Metallic Silver. Note that Moto White is a shade off and a little creamier than Furniture White. The Moto Counter balance and Ratchet height adjustable bases inner and outer columns are only available in**

Contact service@symphonytables.com for complete ordering instructions. Height adjustable bases require a higher level of product understanding and installation.

# bases

## T adjustable height sets

### Moto

base	base dim.	max top support	base set qty	base set model no.	list	glides or casters	finish	
<b>Moto (3" column)</b>								
	pneumatic counter balance	18	24 x 42	2	BTMOT24042SNGME	2,710	adj glides	standard metal
		18	24 x 54	2	BTMOT24054SNGME	2,730	adj glides	standard metal
		18	24 x 60	2	BTMOT24060SNGME	2,740	adj glides	standard metal
		18	24 x 66	2	BTMOT24066SNGME	2,770	adj glides	standard metal
		18	24 x 72	2	BTMOT24072SNGME	2,790	adj glides	standard metal
		18	24 x 42	2	BTMOT24042SNCME	2,790	2" black locking casters	standard metal
		18	24 x 54	2	BTMOT24054SNCME	2,820	2" black locking casters	standard metal
		18	24 x 60	2	BTMOT24060SNCME	2,830	2" black locking casters	standard metal
		18	24 x 66	2	BTMOT24066SNCME	2,860	2" black locking casters	standard metal
		18	24 x 72	2	BTMOT24072SNCME	2,880	2" black locking casters	standard metal
		18	24 x 42	2	BTMOT24042SNPME	2,840	2" premium locking casters	standard metal
		18	24 x 54	2	BTMOT24054SNPME	2,860	2" premium locking casters	standard metal
		18	24 x 60	2	BTMOT24060SNPME	2,870	2" premium locking casters	standard metal
		18	24 x 66	2	BTMOT24066SNPME	2,900	2" premium locking casters	standard metal
		18	24 x 72	2	BTMOT24072SNPME	2,930	2" premium locking casters	standard metal
		22	30 x 42	2	BTMOT30042SNGME	2,730	adj glides	standard metal
		22	30 x 54	2	BTMOT30054SNGME	2,760	adj glides	standard metal
		22	30 x 60	2	BTMOT30060SNGME	2,770	adj glides	standard metal
		22	30 x 66	2	BTMOT30066SNGME	2,790	adj glides	standard metal
		22	30 x 72	2	BTMOT30072SNGME	2,810	adj glides	standard metal
		22	30 x 42	2	BTMOT30042SNCME	2,820	2" black locking casters	standard metal
		22	30 x 54	2	BTMOT30054SNCME	2,850	2" black locking casters	standard metal
		22	30 x 60	2	BTMOT30060SNCME	2,860	2" black locking casters	standard metal
		22	30 x 66	2	BTMOT30066SNCME	2,880	2" black locking casters	standard metal
		22	30 x 72	2	BTMOT30072SNCME	2,890	2" black locking casters	standard metal
		22	30 x 42	2	BTMOT30042SNPME	2,860	2" premium locking casters	standard metal
		22	30 x 54	2	BTMOT30054SNPME	2,890	2" premium locking casters	standard metal
22	30 x 60	2	BTMOT30060SNPME	2,900	2" premium locking casters	standard metal		
22	30 x 66	2	BTMOT30066SNPME	2,930	2" premium locking casters	standard metal		
22	30 x 72	2	BTMOT30072SNPME	2,940	2" premium locking casters	standard metal		
26	36 x 42	2	BTMOT36042SNGME	2,790	adj glides	standard metal		
26	36 x 54	2	BTMOT36054SNGME	2,810	adj glides	standard metal		
26	36 x 60	2	BTMOT36060SNGME	2,830	adj glides	standard metal		
26	36 x 66	2	BTMOT36066SNGME	2,840	adj glides	standard metal		
26	36 x 72	2	BTMOT36072SNGME	2,860	adj glides	standard metal		
26	36 x 42	2	BTMOT36042SNCME	2,880	2" black locking casters	standard metal		
26	36 x 54	2	BTMOT36054SNCME	2,890	2" black locking casters	standard metal		
26	36 x 60	2	BTMOT36060SNCME	2,920	2" black locking casters	standard metal		
26	36 x 66	2	BTMOT36066SNCME	2,930	2" black locking casters	standard metal		
26	36 x 72	2	BTMOT36072SNCME	2,950	2" black locking casters	standard metal		
26	36 x 42	2	BTMOT36042SNPME	2,930	2" premium locking casters	standard metal		
26	36 x 54	2	BTMOT36054SNPME	2,940	2" premium locking casters	standard metal		
26	36 x 60	2	BTMOT36060SNPME	2,960	2" premium locking casters	standard metal		
26	36 x 66	2	BTMOT36066SNPME	2,970	2" premium locking casters	standard metal		
26	36 x 72	2	BTMOT36072SNPME	2,990	2" premium locking casters	standard metal		

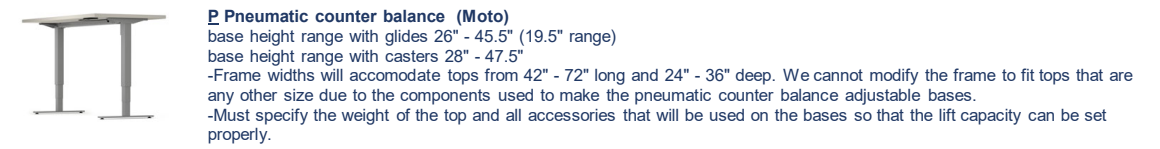

Contact service@symphonytables.com for complete ordering instructions. Height adjustable bases require a higher level of product understanding and installation.

# bases

## T adjustable height sets

### Kenna

base	base dim.	max top support	base set qty	base set model no.	list	glides or casters	finish
<b>Kenna T base sets</b>							
<b>Single Stage Electric</b>							
basic up/down switch	22	24 x 48-72	2	BTKEN24072SEGME	1,430	adj glides	standard metal
	28	30 x 48-72	2	BTKEN30072SEGME	1,480	adj glides	standard metal
programmable switch	22	24 x 48-72	2	BTKEN24072SPGME	1,570	adj glides	standard metal
	28	30 x 48-72	2	BTKEN30072SPGME	1,590	adj glides	standard metal
*tables over 60"L require the Kenna horizontal wire manager							
<b>Dual Stage Electric</b>							
basic up/down switch	22	24 x 48-72	2	BTKEN24072DEGME	1,730	adj glides	standard metal
	28	30 x 48-72	2	BTKEN30072DEGME	1,790	adj glides	standard metal
programmable switch	22	24 x 48-72	2	BTKEN24072DPGME	1,870	adj glides	standard metal
	28	30 x 48-72	2	BTKEN30072DPGME	1,900	adj glides	standard metal
*tables over 60"L require the Kenna horizontal wire manager							

### Kenna 90 degree 3 column: (2) T, (1) post base set



basic up/down switch	22	24 x 48-72	2	BTKE324072SEGME	2,520	adj glides	standard metal
	28	30 x 48-72	2	BTKE330072SEGME	2,540	adj glides	standard metal
programmable switch	22	24 x 48-72	2	BTKE324072SPGME	2,620	adj glides	standard metal
	28	30 x 48-72	2	BTKE330072SPGME	2,640	adj glides	standard metal

\* top not included \*tables over 60"L require the Kenna horizontal wire manager

### Kenna 120 degree 3 column: (2) T, (1) post base set



basic up/down switch	22	24 x 48-60	2	BTKE124060SEGME	2,520	adj glides	standard metal
	28	30 x 48-60	2	BTKE130060SEGME	2,540	adj glides	standard metal
programmable switch	22	24 x 48-60	2	BTKE124060SPGME	2,620	adj glides	standard metal
	28	30 x 48-60	2	BTKE130060SPGME	2,640	adj glides	standard metal

\* top not included

**SEG** Single Stage Electric adj. 27" - 46" (Kenna)  
**DEG** Dual Stage Electric adj. 24" - 48" (Kenna)  
 - basic up / down switch / undersurface mount  
 - adjustment speed 1.375" per second

**SPG** Single Stage Electric adj. 27" - 46" (Kenna)  
**DPG** Dual Stage Electric adj. 24" - 48" (Kenna)  
 - programmable keypad / under surface mount  
 - 4 preset programmable heights  
 - shelf stop and container stop feature that will stop raising or lowering the worksurface if there are items above or below the worksurface that could impact the table  
 - digital display  
 - adjustment speed 1.375" per second



**Kenna horizontal wire manager** connects between the two table legs under the table top, manages wires and supports the worksurface  
 \*for 2 column versions only - not available for 3 column units, only available in a black finish  
 48"-66" tops use model # **OTWMHAT4866 \$120 list**  
 66"-72" tops use model # **OTWMHAT6672 \$170 list**  
**\*required on tables over 60"**



**Kenna 23.5" vertical column wire manager**  
 -bolts into the independent beam and slides around the upper column  
 -allows wires to hang loose so the table can still go up and down while organizing them  
 -can be painted to match base color  
**model # OBTVWMKEN23 \$70 list**

**Kenna weight capacity:**  
 - maximum lifting load 200 lbs. for (2) T or C bases  
 - maximum lifting load 250 lbs 3 column configurations with (2) T bases + (1) post base

**Kenna Standard metal powder coat finishes (ME)**  
 Flat Black, Furniture White, Inner Tone, Light Tone, Medium Tone, and Metallic Silver

SYMPHONY.

2023 PRICE LIST

# bases

## T adjustable height sets

### Matt

base	base dim.	max top support	base set qty	base set model no.	list	glides	finish
<b>Matt II Electric height adjustable T</b>							
<b>Single Stage Electric</b>							
basic up/down switch	23	24 x 48-72	2	BTMA224072SEGFB	1,350	adj glides	flat black
	23	24 x 48-72	2	BTMA224072SEGFW	1,350	adj glides	furniture white
programmable switch	23	24 x 48-72	2	BTMA224072SEGMS	1,350	adj glides	metallic silver
	28	30 x 48-72	2	BTMA230072SEGFB	1,360	adj glides	flat black
programmable switch	28	30 x 48-72	2	BTMA230072SEGFW	1,360	adj glides	furniture white
	28	30 x 48-72	2	BTMA230072SEGMS	1,360	adj glides	metallic silver
*tables over 60"L require the Kenna horizontal wire manager							
<b>Dual Stage Electric</b>							
basic up/down switch w/ sensor control	23	24 x 48-72	2	BTMA224072SPGFB	1,450	adj glides	flat black
	23	24 x 48-72	2	BTMA224072SPGFW	1,450	adj glides	furniture white
programmable switch w/ sensor control	23	24 x 48-72	2	BTMA224072SPGMS	1,450	adj glides	metallic silver
	28	30 x 48-72	2	BTMA230072SPGFB	1,460	adj glides	flat black
programmable switch w/ sensor control	28	30 x 48-72	2	BTMA230072SPGFW	1,460	adj glides	furniture white
	28	30 x 48-72	2	BTMA230072SPGMS	1,460	adj glides	metallic silver
basic up/down switch w/ sensor control	23	24 x 48-72	2	BTMA324072SEGFB	1,460	adj glides	flat black
	23	24 x 48-72	2	BTMA324072SEGFW	1,460	adj glides	furniture white
programmable switch w/ sensor control	23	24 x 48-72	2	BTMA324072SEGMS	1,460	adj glides	metallic silver
	28	30 x 48-72	2	BTMA330072SEGFB	1,470	adj glides	flat black
programmable switch w/ sensor control	28	30 x 48-72	2	BTMA330072SEGFW	1,470	adj glides	furniture white
	28	30 x 48-72	2	BTMA330072SEGMS	1,470	adj glides	metallic silver
basic up/down switch w/ sensor control	23	24 x 48-72	2	BTMA324072SPGFB	1,550	adj glides	flat black
	23	24 x 48-72	2	BTMA324072SPGFW	1,550	adj glides	furniture white
programmable switch w/ sensor control	23	24 x 48-72	2	BTMA324072SPGMS	1,550	adj glides	metallic silver
	28	30 x 48-72	2	BTMA330072SPGFB	1,570	adj glides	flat black
programmable switch w/ sensor control	28	30 x 48-72	2	BTMA330072SPGFW	1,570	adj glides	furniture white
	28	30 x 48-72	2	BTMA330072SPGMS	1,570	adj glides	metallic silver
<b>Dual Stage Electric</b>							
basic up/down switch	23	24 x 48-72	2	BTMA224072DEGFB	1,590	adj glides	flat black
	23	24 x 48-72	2	BTMA224072DEGFW	1,590	adj glides	furniture white
programmable switch	23	24 x 48-72	2	BTMA224072DEGMS	1,590	adj glides	metallic silver
	28	30 x 48-72	2	BTMA230072DEGFB	1,600	adj glides	flat black
programmable switch	28	30 x 48-72	2	BTMA230072DEGFW	1,600	adj glides	furniture white
	28	30 x 48-72	2	BTMA230072DEGMS	1,600	adj glides	metallic silver
basic up/down switch w/ sensor control	23	24 x 48-72	2	BTMA224072DPGFB	1,690	adj glides	flat black
	23	24 x 48-72	2	BTMA224072DPGFW	1,690	adj glides	furniture white
programmable switch w/ sensor control	23	24 x 48-72	2	BTMA224072DPGMS	1,690	adj glides	metallic silver
	28	30 x 48-72	2	BTMA230072DPGFB	1,700	adj glides	flat black
programmable switch w/ sensor control	28	30 x 48-72	2	BTMA230072DPGFW	1,700	adj glides	furniture white
	28	30 x 48-72	2	BTMA230072DPGMS	1,700	adj glides	metallic silver
basic up/down switch w/ sensor control	23	24 x 48-72	2	BTMA324072DEGFB	1,700	adj glides	flat black
	23	24 x 48-72	2	BTMA324072DEGFW	1,700	adj glides	furniture white
programmable switch w/ sensor control	23	24 x 48-72	2	BTMA324072DEGMS	1,700	adj glides	metallic silver
	28	30 x 48-72	2	BTMA330072DEGFB	1,710	adj glides	flat black
programmable switch w/ sensor control	28	30 x 48-72	2	BTMA330072DEGFW	1,710	adj glides	furniture white
	28	30 x 48-72	2	BTMA330072DEGMS	1,710	adj glides	metallic silver
basic up/down switch w/ sensor control	23	24 x 48-72	2	BTMA324072DPGFB	1,790	adj glides	flat black
	23	24 x 48-72	2	BTMA324072DPGFW	1,790	adj glides	furniture white
programmable switch w/ sensor control	23	24 x 48-72	2	BTMA324072DPGMS	1,790	adj glides	metallic silver
	28	30 x 48-72	2	BTMA330072DPGFB	1,810	adj glides	flat black
programmable switch w/ sensor control	28	30 x 48-72	2	BTMA330072DPGFW	1,810	adj glides	furniture white
	28	30 x 48-72	2	BTMA330072DPGMS	1,810	adj glides	metallic silver

\* top not included

**SEG** Single Stage Electric adj. 26" - 45"  
**DEG** Dual Stage Electric adj. 21.75" - 47.75"  
 - basic up / down switch / undersurface mount  
 - adjustment speed 1.375" per second

**SPG** Single Stage Electric adj. 26" - 45"  
**DPG** Dual Stage Electric adj. 21.75" - 47.75"  
 - programmable keypad / under surface mount  
 - 4 preset programmable heights  
 - digital display  
 - adjustment speed 1.375" per second

### Matt II Standard metal finish options

**FB** Flat Black  
**FW** Furniture White  
**MS** Metallic Silver

**Sensor control**  
 Sensor - collision mitigation option significantly increases the safety of the height adjustable table. It detects collision when the table is moved and can significantly reduce damage to the table and the colliding object.

**Matt II weight capacity:**  
 - maximum lifting load 250 lbs. for (2) T bases (including the top)





SYMPHONY.

2023 PRICE LIST

# bases

## C fixed single column sets

### Keller, Ria

base	base dim.	max top support	base set qty	base set model no.	list	glides or casters	finish
	15	20 x 96	2	BCKEL20096SDGME	620	adj glides	standard metal
	22	24 x 96	2	BCKEL24096SDGME	670	adj glides	standard metal
	27	30 x 96	2	BCKEL30096SDGME	720	adj glides	standard metal
	15	20 x 96	2	BCKEL20096SDCME	700	2" black hard casters	standard metal
	22	24 x 96	2	BCKEL24096SDCME	750	2" black hard casters	standard metal
	27	30 x 96	2	BCKEL30096SDCME	800	2" black hard casters	standard metal
	15	20 x 96	2	BCKEL20096SDSME	740	2" black soft casters	standard metal
	22	24 x 96	2	BCKEL24096SDSME	790	2" black soft casters	standard metal
	27	30 x 96	2	BCKEL30096SDSME	840	2" black soft casters	standard metal
	15	20 x 96	2	BCKEL20096SDGPO	840	adj glides	polished
	22	24 x 96	2	BCKEL24096SDGPO	890	adj glides	polished
	27	30 x 96	2	BCKEL30096SDGPO	940	adj glides	polished
	15	20 x 96	2	BCKEL20096SDCPO	920	2" black hard casters	polished
	22	24 x 96	2	BCKEL24096SDCPO	970	2" black hard casters	polished
	27	30 x 96	2	BCKEL30096SDCPO	1,020	2" black hard casters	polished
15	20 x 96	2	BCKEL20096SDSPO	960	2" black soft casters	polished	
22	24 x 96	2	BCKEL24096SDSPO	1,010	2" black soft casters	polished	
27	30 x 96	2	BCKEL30096SDSPO	1,060	2" black soft casters	polished	
	15	20 x 96	2	BCRIA20096SDGME	590	adj glides	standard metal
	22	24 x 96	2	BCRIA24096SDGME	620	adj glides	standard metal
	27	30 x 96	2	BCRIA30096SDGME	670	adj glides	standard metal
	15	20 x 96	2	BCRIA20096SDCME	670	2" black hard casters	standard metal
	22	24 x 96	2	BCRIA24096SDCME	700	2" black hard casters	standard metal
	27	30 x 96	2	BCRIA30096SDCME	750	2" black hard casters	standard metal
	15	20 x 96	2	BCRIA20096SDSME	710	2" black soft casters	standard metal
	22	24 x 96	2	BCRIA24096SDSME	740	2" black soft casters	standard metal
	27	30 x 96	2	BCRIA30096SDSME	790	2" black soft casters	standard metal
	15	20 x 96	2	BCRIA20096SDGPO	780	adj glides	polished
	22	24 x 96	2	BCRIA24096SDGPO	810	adj glides	polished
	27	30 x 96	2	BCRIA30096SDGPO	870	adj glides	polished
	15	20 x 96	2	BCRIA20096SDCPO	860	2" black hard casters	polished
	22	24 x 96	2	BCRIA24096SDCPO	890	2" black hard casters	polished
	27	30 x 96	2	BCRIA30096SDCPO	950	2" black hard casters	polished
15	20 x 96	2	BCRIA20096SDSPO	900	2" black soft casters	polished	
22	24 x 96	2	BCRIA24096SDSPO	930	2" black soft casters	polished	
27	30 x 96	2	BCRIA30096SDSPO	990	2" black soft casters	polished	

- C casters**  
2" black dual wheel locking hard casters (for carpet)
- S casters (Keller/Ria)**  
2" black dual wheel locking soft casters (for hard floors)

**(ME) Standard metal powder coat finishes :**  
Black Wrinkle (BW), Chateau Brown Wrinkle (CB), Flat Black (FB), Furniture White (FW), Inner Tone (IT), Light Tone (LT), Medium Tone (MT), Metallic Silver (MS).





**(PQ) Polished aluminum / chrome finish (Keller / Ria)**

**(PC) Polished chrome finish (Novi)**

# bases

## C fixed single column sets

### Moto, Moto 2, Zoey, Novi

base	base dim.	max top support	base set qty	base set model no.	list	glides or casters	finish	
	Moto (3" column)	18	24 x 96	2	BCMOT24096SDGME	830	adj glides	standard metal
		22	30 x 96	2	BCMOT30096SDGME	870	adj glides	standard metal
		26	36 x 96	2	BCMOT36096SDGME	910	adj glides	standard metal
		18	24 x 96	2	BCMOT24096SDCME	910	2" black locking casters	standard metal
		22	30 x 96	2	BCMOT30096SDCME	960	2" black locking casters	standard metal
		26	36 x 96	2	BCMOT36096SDCME	1,000	2" black locking casters	standard metal
		18	24 x 96	2	BCMOT24096SDPME	960	2" premium locking casters	standard metal
		22	30 x 96	2	BCMOT30096SDPME	1,000	2" premium locking casters	standard metal
		26	36 x 96	2	BCMOT36096SDPME	1,050	2" premium locking casters	standard metal
	Moto 2 (2" column)	18	24 x 96	2	BCMO224096SDGME	680	adj glides	standard metal
		22	30 x 96	2	BCMO230096SDGME	720	adj glides	standard metal
		26	36 x 96	2	BCMO236096SDGME	750	adj glides	standard metal
		18	24 x 96	2	BCMO224096SDCME	770	2" black locking casters	standard metal
		22	30 x 96	2	BCMO230096SDCME	800	2" black locking casters	standard metal
		26	36 x 96	2	BCMO236096SDCME	840	2" black locking casters	standard metal
		18	24 x 96	2	BCMO224096SDPME	810	2" premium locking casters	standard metal
		22	30 x 96	2	BCMO230096SDPME	850	2" premium locking casters	standard metal
		26	36 x 96	2	BCMO236096SDPME	880	2" premium locking casters	standard metal
	Zoey	18	20 x 96	2	BCZOE20096SDGME	570	adj glides	standard metal
		21	24 x 96	2	BCZOE24096SDGME	610	adj glides	standard metal
		27	30 x 96	2	BCZOE30096SDGME	650	adj glides	standard metal
		18	20 x 96	2	BCZOE20096SDCME	660	3" black locking casters	standard metal
		21	24 x 96	2	BCZOE24096SDCME	690	3" black locking casters	standard metal
		27	30 x 96	2	BCZOE30096SDCME	740	3" black locking casters	standard metal
		18	20 x 96	2	BCZOE20096SDPME	700	3" premium locking casters	standard metal
		21	24 x 96	2	BCZOE24096SDPME	740	3" premium locking casters	standard metal
		27	30 x 96	2	BCZOE30096SDPME	780	3" premium locking casters	standard metal
	Novi	18	20 x 96	2	BCNOV20096SDGME	640	adj glides	standard metal
		22	24 x 96	2	BCNOV24096SDGME	660	adj glides	standard metal
		26	30 x 96	2	BCNOV30096SDGME	690	adj glides	standard metal
		18	20 x 96	2	BCNOV20096SDCME	730	2" black locking casters	standard metal
		22	24 x 96	2	BCNOV24096SDCME	750	2" black locking casters	standard metal
		26	30 x 96	2	BCNOV30096SDCME	780	2" black locking casters	standard metal
		18	20 x 96	2	BCNOV20096SDHME	750	glides/concealed casters	standard metal
		22	24 x 96	2	BCNOV24096SDHME	770	glides/concealed casters	standard metal
		26	30 x 96	2	BCNOV30096SDHME	800	glides/concealed casters	standard metal
		18	20 x 96	2	BCNOV20096SDGPC	1,000	adj glides	polished
		22	24 x 96	2	BCNOV24096SDGPC	1,020	adj glides	polished
		26	30 x 96	2	BCNOV30096SDGPC	1,050	adj glides	polished
		18	20 x 96	2	BCNOV20096SDCPC	1,080	2" black locking casters	polished
		22	24 x 96	2	BCNOV24096SDCPC	1,090	2" black locking casters	polished
		26	30 x 96	2	BCNOV30096SDCPC	1,130	2" black locking casters	polished

- C casters**  
2" black dual wheel locking (Moto, Moto 2)  
3" black dual wheel locking (Zoey)
- P premium casters**  
2" silver/black dual wheel locking - (Moto, Moto 2)  
3" white dual wheel locking (Zoey)
- H Novi hidden/concealed casters**  
one T base per set has glides, the other base has hidden/concealed casters (not available for polished finish)



**(ME) Standard metal powder coat finishes :**  
Black Wrinkle (BW), Chateau Brown Wrinkle (CB), Flat Black (FB), Furniture White (FW), Inner Tone (IT), Light Tone (LT), Medium Tone (MT), Metallic Silver (MS).

**(PC) Polished chrome finish (Novi)**

# bases

## C nesting sets

### Keller, Ria, Novi

base	base dim.	max top support	base set qty	base set model no.	list	glides or casters	finish
	15	20 x 72	2	BCKEL20072NEGME	1,060	adj glides	standard metal
	22	24 x 72	2	BCKEL24072NEGME	1,110	adj glides	standard metal
	27	30 x 72	2	BCKEL30072NEGME	1,160	adj glides	standard metal
	15	20 x 72	2	BCKEL20072NECME	1,140	2" black hard casters	standard metal
	22	24 x 72	2	BCKEL24072NECME	1,190	2" black hard casters	standard metal
	27	30 x 72	2	BCKEL30072NECME	1,240	2" black hard casters	standard metal
	15	20 x 72	2	BCKEL20072NESME	1,180	2" black soft casters	standard metal
	22	24 x 72	2	BCKEL24072NESME	1,230	2" black soft casters	standard metal
	27	30 x 72	2	BCKEL30072NESME	1,280	2" black soft casters	standard metal
	15	20 x 72	2	BCKEL20072NEGPO	1,280	adj glides	polished
	22	24 x 72	2	BCKEL24072NEGPO	1,320	adj glides	polished
	27	30 x 72	2	BCKEL30072NEGPO	1,380	adj glides	polished
	15	20 x 72	2	BCKEL20072NECPO	1,360	2" black hard casters	polished
	22	24 x 72	2	BCKEL24072NECPO	1,400	2" black hard casters	polished
	27	30 x 72	2	BCKEL30072NECPO	1,460	2" black hard casters	polished
15	20 x 72	2	BCKEL20072NESPO	1,400	2" black soft casters	polished	
22	24 x 72	2	BCKEL24072NESPO	1,440	2" black soft casters	polished	
27	30 x 72	2	BCKEL30072NESPO	1,500	2" black soft casters	polished	
	15	20 x 72	2	BCRIA20072NEGME	1,030	adj glides	standard metal
	22	24 x 72	2	BCRIA24072NEGME	1,060	adj glides	standard metal
	27	30 x 72	2	BCRIA30072NEGME	1,110	adj glides	standard metal
	15	20 x 72	2	BCRIA20072NECME	1,110	2" black hard casters	standard metal
	22	24 x 72	2	BCRIA24072NECME	1,140	2" black hard casters	standard metal
	27	30 x 72	2	BCRIA30072NECME	1,190	2" black hard casters	standard metal
	15	20 x 72	2	BCRIA20072NESME	1,150	2" black soft casters	standard metal
	22	24 x 72	2	BCRIA24072NESME	1,180	2" black soft casters	standard metal
	27	30 x 72	2	BCRIA30072NESME	1,230	2" black soft casters	standard metal
	15	20 x 72	2	BCRIA20072NEGPO	1,220	adj glides	polished
	22	24 x 72	2	BCRIA24072NEGPO	1,250	adj glides	polished
	27	30 x 72	2	BCRIA30072NEGPO	1,300	adj glides	polished
	15	20 x 72	2	BCRIA20072NECPO	1,300	2" black hard casters	polished
	22	24 x 72	2	BCRIA24072NECPO	1,330	2" black hard casters	polished
	27	30 x 72	2	BCRIA30072NECPO	1,380	2" black hard casters	polished
15	20 x 72	2	BCRIA20072NESPO	1,340	2" black soft casters	polished	
22	24 x 72	2	BCRIA24072NESPO	1,370	2" black soft casters	polished	
27	30 x 72	2	BCRIA30072NESPO	1,420	2" black soft casters	polished	
	18	20 x 72	2	BCNOV20072NEGME	1,250	adj glides	standard metal
	22	24 x 72	2	BCNOV24072NEGME	1,280	adj glides	standard metal
	26	30 x 72	2	BCNOV30072NEGME	1,290	adj glides	standard metal
	18	20 x 72	2	BCNOV20072NECME	1,340	2" black locking casters	standard metal
	22	24 x 72	2	BCNOV24072NECME	1,360	2" black locking casters	standard metal
	26	30 x 72	2	BCNOV30072NECME	1,380	2" black locking casters	standard metal

**C casters**  
2" black dual wheel locking hard casters (for carpet)

**S casters (Keller/Ria)**  
2" black dual wheel locking soft casters (for hard floors)

**KELLER, RIA, ROSANNO AND NOVI SINGLE T FLIP MECH**  
IMAGE:



**(ME) Standard metal powder coat finishes :**  
Black Wrinkle (BW), Chateau Brown Wrinkle (CB), Flat Black (FB), Furniture White (FW), Inner Tone (IT), Light Tone (LT), Medium Tone (MT), Metallic Silver (MS).



**(PO) Polished aluminum / chrome finish (Keller / Ria)**

Note that the Keller, Ria and Novi single column series bases do not have a beam and therefore the bases cannot be spread more than 50" apart at center.

# bases

## C nesting sets

### Zoey, Moto

base	base dim.	max top support	base set qty	base set model no.	list	glides or casters	finish
	15	20 x 60	2	BCZOE20060NBGM	1,290	adj glides	standard metal
	15	20 x 72	2	BCZOE20072NBGM	1,310	adj glides	standard metal
	21	24 x 60	2	BCZOE24060NBGM	1,310	adj glides	standard metal
	21	24 x 72	2	BCZOE24072NBGM	1,330	adj glides	standard metal
	27	30 x 60	2	BCZOE30060NBGM	1,330	adj glides	standard metal
	27	30 x 72	2	BCZOE30072NBGM	1,350	adj glides	standard metal
	15	20 x 60	2	BCZOE20060NBCME	1,330	3" black locking casters	standard metal
	15	20 x 72	2	BCZOE20072NBCME	1,350	3" black locking casters	standard metal
	21	24 x 60	2	BCZOE24060NBCME	1,350	3" black locking casters	standard metal
	21	24 x 72	2	BCZOE24072NBCME	1,380	3" black locking casters	standard metal
	27	30 x 60	2	BCZOE30060NBCME	1,380	3" black locking casters	standard metal
	27	30 x 72	2	BCZOE30072NBCME	1,400	3" black locking casters	standard metal
	15	20 x 60	2	BCZOE20060NBPME	1,380	3" premium locking casters	standard metal
	15	20 x 72	2	BCZOE20072NBPME	1,400	3" premium locking casters	standard metal
	21	24 x 60	2	BCZOE24060NBPME	1,400	3" premium locking casters	standard metal
21	24 x 72	2	BCZOE24072NBPME	1,420	3" premium locking casters	standard metal	
27	30 x 60	2	BCZOE30060NBPME	1,420	3" premium locking casters	standard metal	
27	30 x 72	2	BCZOE30072NBPME	1,440	3" premium locking casters	standard metal	
	18	24 x 60	2	BCMO224060NBGM	1,440	adj glides	standard metal
	18	24 x 72	2	BCMO230072NBGM	1,450	adj glides	standard metal
	22	30 x 60	2	BCMO230060NBGM	1,470	adj glides	standard metal
	22	30 x 72	2	BCMO230072NBGM	1,490	adj glides	standard metal
	18	24 x 60	2	BCMO224060NBCME	1,530	2" black locking casters	standard metal
	18	24 x 72	2	BCMO230072NBCME	1,540	2" black locking casters	standard metal
	22	30 x 60	2	BCMO230060NBCME	1,560	2" black locking casters	standard metal
	22	30 x 72	2	BCMO230072NBCME	1,570	2" black locking casters	standard metal
	18	24 x 60	2	BCMO224060NBPME	1,570	2" premium locking casters	standard metal
	18	24 x 72	2	BCMO230072NBPME	1,580	2" premium locking casters	standard metal
	22	30 x 60	2	BCMO230060NBPME	1,610	2" premium locking casters	standard metal
	22	30 x 72	2	BCMO230072NBPME	1,620	2" premium locking casters	standard metal

**C casters**  
2" black dual wheel locking (Moto 2)  
3" black dual wheel locking (Zoey)

**P premium casters**  
2" silver/black dual wheel locking (Moto 2)  
3" white dual wheel locking (Zoey)

**(ME) Standard metal powder coat finishes :**  
Black Wrinkle (BW), Chateau Brown Wrinkle (CB), Flat Black (FB), Furniture White (FW), Inner Tone (IT), Light Tone (LT), Medium Tone (MT), Metallic Silver (MS).

**Moto and Zoey flip nest bases with a beam do not require top stiffeners**  
The cost of the top stiffener is included in the standard Symphony top price.  
Deduct the following from the list price shown for a top in the top section of the price list

-\$70 list for tops that are 18-24" deep x 60 long (1 stiffener)  
-\$90 list for tops that are 18-24" deep x 72 long (1 stiffener)







-\$140 list for tops that are 30-36" deep x 60 long (2 stiffeners)  
-\$170 list for tops that are 30-36" deep x 72 long (2 stiffeners)

Note that the "NE" model numbers do not have a beam and therefore the bases cannot be spread more than 50" apart at center when using top stiffeners.



# bases

C adjustable height sets  
Keller, Ria, Novi, Moto, Kenna

base	base dim.	max top support	base set qty	base set model no.	list	glides or casters	finish		
Keller 	spring clip	15	20 x 72	2	BCKEL20072SSGME	920	adj glides	standard metal	
		22	24 x 72	2	BCKEL24072SSGME	970	adj glides	standard metal	
		27	30 x 72	2	BCKEL30072SSGME	1,020	adj glides	standard metal	
			15	20 x 72	2	BCKEL20072SSCME	1,000	2" black hard casters	standard metal
			22	24 x 72	2	BCKEL24072SSCME	1,050	2" black hard casters	standard metal
			27	30 x 72	2	BCKEL30072SSCME	1,100	2" black hard casters	standard metal
			15	20 x 72	2	BCKEL20072SSSME	1,040	2" black soft casters	standard metal
			22	24 x 72	2	BCKEL24072SSSME	1,090	2" black soft casters	standard metal
			27	30 x 72	2	BCKEL30072SSSME	1,140	2" black soft casters	standard metal
Ria 	spring clip	15	20 x 72	2	BCRIA20072SSGME	890	adj glides	standard metal	
		22	24 x 72	2	BCRIA24072SSGME	910	adj glides	standard metal	
		27	30 x 72	2	BCRIA30072SSGME	970	adj glides	standard metal	
			15	20 x 72	2	BCRIA20072SSCME	970	2" black hard casters	standard metal
			22	24 x 72	2	BCRIA24072SSCME	990	2" black hard casters	standard metal
			27	30 x 72	2	BCRIA30072SSCME	1,050	2" black hard casters	standard metal
			15	20 x 72	2	BCRIA20072SSSME	1,010	2" black soft casters	standard metal
			22	24 x 72	2	BCRIA24072SSSME	1,030	2" black soft casters	standard metal
			27	30 x 72	2	BCRIA30072SSSME	1,090	2" black soft casters	standard metal
Novi 	spring clip	18	20 x 72	2	BCNOV20072SSGME	960	adj glides	standard metal	
		22	24 x 72	2	BCNOV24072SSGME	990	adj glides	standard metal	
		26	30 x 72	2	BCNOV30072SSGME	1,010	adj glides	standard metal	
			18	20 x 72	2	BCNOV20072SSCME	1,050	2" black locking casters	standard metal
			22	24 x 72	2	BCNOV24072SSCME	1,080	2" black locking casters	standard metal
			26	30 x 72	2	BCNOV30072SSCME	1,100	2" black locking casters	standard metal
Moto (3" column) 	crank	18	24 x 72	2	BCMOT24072SCGME	1,530	adj glides	standard metal	
		22	30 x 72	2	BCMOT30072SCGME	1,540	adj glides	standard metal	
		26	36 x 72	2	BCMOT36072SCGME	1,600	adj glides	standard metal	
			18	24 x 72	2	BCMOT24072SCCME	1,620	2" black locking casters	standard metal
			22	30 x 72	2	BCMOT30072SCCME	1,630	2" black locking casters	standard metal
			26	36 x 72	2	BCMOT36072SCCME	1,660	2" black locking casters	standard metal
	ANSI/BIFMA electric 2-stage 	basic switch	18	24 x 72	2	BCMO324072SEGME	3,240	adj glides	standard metal
			22	30 x 72	2	BCMO330072SEGME	3,250	adj glides	standard metal
			26	36 x 72	2	BCMO336072SEGME	3,280	adj glides	standard metal
		programmable switch	18	24 x 72	2	BCMO324072SPGME	3,360	adj glides	standard metal
			22	30 x 72	2	BCMO330072SPGME	3,380	adj glides	standard metal
			26	36 x 72	2	BCMO336072SPGME	3,400	adj glides	standard metal
Kenna Single Stage Electric 	basic up/down switch	22	24 x 48-72	2	BCKEN24072SEGME	1,430	adj glides	standard metal	
		28	30 x 48-72	2	BCKEN30072SEGME	1,480	adj glides	standard metal	
	programmable switch	22	24 x 48-72	2	BCKEN24072SPGME	1,570	adj glides	standard metal	
		28	30 x 48-72	2	BCKEN30072SPGME	1,590	adj glides	standard metal	

**C casters**  
2" black dual wheel locking hard casters (for carpet)  
**S casters (Keller/Ria)**  
2" black dual wheel locking soft casters (for hard floors)

**Standard metal powder coat finishes (ME)**  
Flat Black, Furniture White, Inner Tone, Light Tone, Medium Tone, and Metallic Silver  
\*\* Note that the inner column of Moto and Kenna height adjustable bases are only available in black, white or metallic silver. Note that Moto White is a shade off and a little creamier than Furniture White.

**S Spring clip height adjustment**  
24.75" - 33.75" height range (Ria, Keller, Novi)  
six heights in 1" increments  
available for C base tables up to 30" deep

**C Crank adjustment (Moto)**  
base height with glides 26" - 43.75" (17.75" range)  
base height with casters 28" - 45.75"  
\*additional height ranges available - contact Symphony  
-screw thread adjustment with infinite stop positions  
-adjust with manual crank handle which slides under table when not in use  
-maximum lifting load 225 lbs for two columns (C base set)

**SEG Electric adj. 21" - 47" (Moto)**  
- simple up-down control  
- maximum lifting load 225 lbs for 2 columns (set of C bases)

**SPG Electric adj. 21" - 47" (Moto)**  
- programmable keypad control  
- maximum lifting load 225 lbs for 2 columns (set of C bases)



**SEG Single Stage Electric adj. 27" - 46" (Kenna)**  
- basic up / down switch / undersurface mount  
- adjustment speed 1.375" per second

**SPG Single Stage Electric adj. 27" - 46" (Kenna)**  
-programmable keypad / under surface mount  
-4 preset programmable heights  
-shelf stop and container stop feature that will stop raising or lowering the worksurface if there are items above or below the worksurface that could impact the table  
-digital display  
- adjustment speed 1.375" per second

**Kenna weight capacity:** maximum lifting load 200 lbs. for (2) C bases

# bases

C adjustable height sets  
Matt II

base	base dim.	max top support	base set qty	base set model no.	list	glides	finish	
Matt II Electric height adjustable C Single Stage Electric 	basic up/down switch	23	24 x 48-72	2	BCMA224072SEGF	1,350	adj glides	flat black
		23	24 x 48-72	2	BCMA224072SEGF	1,350	adj glides	furniture white
		23	24 x 48-72	2	BCMA224072SEGMS	1,350	adj glides	metallic silver
		28	30 x 48-72	2	BCMA230072SEGF	1,360	adj glides	flat black
		28	30 x 48-72	2	BCMA230072SEGF	1,360	adj glides	furniture white
		28	30 x 48-72	2	BCMA230072SEGMS	1,360	adj glides	metallic silver
	programmable switch	23	24 x 48-72	2	BCMA224072SPGF	1,450	adj glides	flat black
		23	24 x 48-72	2	BCMA224072SPGF	1,450	adj glides	furniture white
		23	24 x 48-72	2	BCMA224072SPGMS	1,450	adj glides	metallic silver
		28	30 x 48-72	2	BCMA230072SPGF	1,460	adj glides	flat black
		28	30 x 48-72	2	BCMA230072SPGF	1,460	adj glides	furniture white
		28	30 x 48-72	2	BCMA230072SPGMS	1,460	adj glides	metallic silver
	basic up/down switch w/ sensor control	23	24 x 48-72	2	BCMA324072SEGF	1,460	adj glides	flat black
		23	24 x 48-72	2	BCMA324072SEGF	1,460	adj glides	furniture white
		23	24 x 48-72	2	BCMA324072SEGMS	1,460	adj glides	metallic silver
		28	30 x 48-72	2	BCMA330072SEGF	1,470	adj glides	flat black
		28	30 x 48-72	2	BCMA330072SEGF	1,470	adj glides	furniture white
		28	30 x 48-72	2	BCMA330072SEGMS	1,470	adj glides	metallic silver
	programmable switch w/ sensor control	23	24 x 48-72	2	BCMA324072SPGF	1,550	adj glides	flat black
		23	24 x 48-72	2	BCMA324072SPGF	1,550	adj glides	furniture white
		23	24 x 48-72	2	BCMA324072SPGMS	1,550	adj glides	metallic silver
		28	30 x 48-72	2	BCMA330072SPGF	1,570	adj glides	flat black
		28	30 x 48-72	2	BCMA330072SPGF	1,570	adj glides	furniture white
		28	30 x 48-72	2	BCMA330072SPGMS	1,570	adj glides	metallic silver
Dual Stage Electric 	basic up/down switch	23	24 x 48-72	2	BCMA224072DEGF	1,590	adj glides	flat black
		23	24 x 48-72	2	BCMA224072DEGF	1,590	adj glides	furniture white
		23	24 x 48-72	2	BCMA224072DEGMS	1,590	adj glides	metallic silver
		28	30 x 48-72	2	BCMA230072DEGF	1,600	adj glides	flat black
		28	30 x 48-72	2	BCMA230072DEGF	1,600	adj glides	furniture white
		28	30 x 48-72	2	BCMA230072DEGMS	1,600	adj glides	metallic silver
	programmable switch	23	24 x 48-72	2	BCMA224072DPGF	1,690	adj glides	flat black
		23	24 x 48-72	2	BCMA224072DPGF	1,690	adj glides	furniture white
		23	24 x 48-72	2	BCMA224072DPGMS	1,690	adj glides	metallic silver
		28	30 x 48-72	2	BCMA230072DPGF	1,700	adj glides	flat black
		28	30 x 48-72	2	BCMA230072DPGF	1,700	adj glides	furniture white
		28	30 x 48-72	2	BCMA230072DPGMS	1,700	adj glides	metallic silver
	basic up/down switch w/ sensor control	23	24 x 48-72	2	BCMA324072DEGF	1,700	adj glides	flat black
		23	24 x 48-72	2	BCMA324072DEGF	1,700	adj glides	furniture white
		23	24 x 48-72	2	BCMA324072DEGMS	1,700	adj glides	metallic silver
		28	30 x 48-72	2	BCMA330072DEGF	1,710	adj glides	flat black
		28	30 x 48-72	2	BCMA330072DEGF	1,710	adj glides	furniture white
		28	30 x 48-72	2	BCMA330072DEGMS	1,710	adj glides	metallic silver
	programmable switch w/ sensor control	23	24 x 48-72	2	BCMA324072DPGF	1,790	adj glides	flat black
		23	24 x 48-72	2	BCMA324072DPGF	1,790	adj glides	furniture white
		23	24 x 48-72	2	BCMA324072DPGMS	1,790	adj glides	metallic silver
		28	30 x 48-72	2	BCMA330072DPGF	1,810	adj glides	flat black
		28	30 x 48-72	2	BCMA330072DPGF	1,810	adj glides	furniture white
		28	30 x 48-72	2	BCMA330072DPGMS	1,810	adj glides	metallic silver

\* top not included

**Matt Standard metal finish options**  
FB Flat Black  
FW Furniture White  
MS Metallic Silver

**Sensor control**  
Sensor - collision mitigation option significantly increases the safety of the height adjustable table. It detects collision when the table is moved and can significantly reduce damage to the table and the colliding object.

**SEG Single Stage Electric adj. 26" - 45"**  
**DEG Dual Stage Electric adj. 21.75" - 47.75"**  
- basic up / down switch / undersurface mount  
- adjustment speed 1.375" per second

**SPG Single Stage Electric adj. 26" - 45"**  
**DPG Dual Stage Electric adj. 21.75" - 47.75"**  
-programmable keypad / under surface mount  
-4 preset programmable heights  
-digital display  
-adjustment speed 1.375" per second

**Matt weight capacity:**  
- maximum lifting load 250 lbs. for (2) C bases (including the top)

# bases

## X fixed

### Keller

base	base dim.	max top support	base qty	base model no.	list	glides or casters	finish
Keller 27.75"H X	20 x 20	24 x 24, 24 rd	1	BXKEL24024SDGME	530	adj glides	standard metal
	26 x 26	30 x 30, 36 rd	1	BXKEL30030SDGME	590	adj glides	standard metal
	33 x 33	36 x 36, 42 rd	1	BXKEL36036SDGME	660	adj glides	standard metal
	38 x 38	42 x 42, 48 rd	1	BXKEL42042SDGME	790	adj glides	standard metal
	20 x 20	24 x 24, 24 rd	1	BXKEL24024SDCME	610	2" black hard casters	standard metal
	26 x 26	30 x 30, 36 rd	1	BXKEL30030SDCME	670	2" black hard casters	standard metal
	33 x 33	36 x 36, 42 rd	1	BXKEL36036SDCME	740	2" black hard casters	standard metal
	38 x 38	42 x 42, 48 rd	1	BXKEL42042SDCME	870	2" black hard casters	standard metal
	20 x 20	24 x 24, 24 rd	1	BXKEL24024SDSME	650	2" black soft casters	standard metal
	26 x 26	30 x 30, 36 rd	1	BXKEL30030SDSME	710	2" black soft casters	standard metal
	33 x 33	36 x 36, 42 rd	1	BXKEL36036SDSME	780	2" black soft casters	standard metal
	38 x 38	42 x 42, 48 rd	1	BXKEL42042SDSME	910	2" black soft casters	standard metal
	20 x 20	24 x 24, 24 rd	1	BXKEL24024SDGPO	680	adj glides	polished
	26 x 26	30 x 30, 36 rd	1	BXKEL30030SDGPO	740	adj glides	polished
	33 x 33	36 x 36, 42 rd	1	BXKEL36036SDGPO	810	adj glides	polished
	38 x 38	42 x 42, 48 rd	1	BXKEL42042SDGPO	930	adj glides	polished
	20 x 20	24 x 24, 24 rd	1	BXKEL24024SDCPO	760	2" black hard casters	polished
	26 x 26	30 x 30, 36 rd	1	BXKEL30030SDCPO	820	2" black hard casters	polished
	33 x 33	36 x 36, 42 rd	1	BXKEL36036SDCPO	890	2" black hard casters	polished
	38 x 38	42 x 42, 48 rd	1	BXKEL42042SDCPO	1,010	2" black hard casters	polished
	20 x 20	24 x 24, 24 rd	1	BXKEL24024SDSPO	800	2" black soft casters	polished
	26 x 26	30 x 30, 36 rd	1	BXKEL30030SDSPO	860	2" black soft casters	polished
	33 x 33	36 x 36, 42 rd	1	BXKEL36036SDSPO	930	2" black soft casters	polished
	38 x 38	42 x 42, 48 rd	1	BXKEL42042SDSPO	1,050	2" black soft casters	polished

For complete custom lower height or custom higher height base model number:

1. Insert height selection:

**SB** bar height (40.75"H)

**SH** custom Higher fixed height - specify height

**SL** custom Lower fixed height - specify height

bar or custom height	base dim.	max top support	base qty	base model no.	list	glides or casters	finish
bar or custom height	20 x 20	24 x 24, 24 rd	1	BXKEL24024__GME	620	adj glides	standard metal
	26 x 26	30 x 30, 36 rd	1	BXKEL30030__GME	680	adj glides	standard metal
	33 x 33	36 x 36, 42 rd	1	BXKEL36036__GME	750	adj glides	standard metal
	38 x 38	42 x 42, 48 rd	1	BXKEL42042__GME	880	adj glides	standard metal
	20 x 20	24 x 24, 24 rd	1	BXKEL24024__CME	700	2" black hard casters	standard metal
	26 x 26	30 x 30, 36 rd	1	BXKEL30030__CME	760	2" black hard casters	standard metal
	33 x 33	36 x 36, 42 rd	1	BXKEL36036__CME	830	2" black hard casters	standard metal
	38 x 38	42 x 42, 48 rd	1	BXKEL42042__CME	960	2" black hard casters	standard metal
	20 x 20	24 x 24, 24 rd	1	BXKEL24024__SME	740	2" black soft casters	standard metal
	26 x 26	30 x 30, 36 rd	1	BXKEL30030__SME	800	2" black soft casters	standard metal
	33 x 33	36 x 36, 42 rd	1	BXKEL36036__SME	870	2" black soft casters	standard metal
	38 x 38	42 x 42, 48 rd	1	BXKEL42042__SME	1,000	2" black soft casters	standard metal
	20 x 20	24 x 24, 24 rd	1	BXKEL24024__GPO	770	adj glides	polished
	26 x 26	30 x 30, 36 rd	1	BXKEL30030__GPO	830	adj glides	polished
	33 x 33	36 x 36, 42 rd	1	BXKEL36036__GPO	900	adj glides	polished
	38 x 38	42 x 42, 48 rd	1	BXKEL42042__GPO	1,020	adj glides	polished
	20 x 20	24 x 24, 24 rd	1	BXKEL24024__CPO	850	2" black hard casters	polished
	26 x 26	30 x 30, 36 rd	1	BXKEL30030__CPO	910	2" black hard casters	polished
	33 x 33	36 x 36, 42 rd	1	BXKEL36036__CPO	980	2" black hard casters	polished
	38 x 38	42 x 42, 48 rd	1	BXKEL42042__CPO	1,100	2" black hard casters	polished
	20 x 20	24 x 24, 24 rd	1	BXKEL24024__SPO	890	2" black soft casters	polished
	26 x 26	30 x 30, 36 rd	1	BXKEL30030__SPO	950	2" black soft casters	polished
	33 x 33	36 x 36, 42 rd	1	BXKEL36036__SPO	1,020	2" black soft casters	polished
	38 x 38	42 x 42, 48 rd	1	BXKEL42042__SPO	1,140	2" black soft casters	polished

**C casters**

2" black dual wheel locking hard casters (for carpet)

**S casters**

2" black dual wheel locking soft casters (for hard floors)

**Standard metal powder coat finishes (ME)**

Black Wrinkle, Chateau Brown Wrinkle, Flat Black, Furniture White, Inner Tone, Light Tone, Medium Tone and Metallic Silver

**Premium Polished Finish (PO)**

Polished Aluminum/Steel

# bases

## offset X fixed

### Keller

base	base dim.	max top support	base qty	base model no.	list	glides or casters	finish
Keller 27.75"H offset X	20 x 26	24 x 30	1	BXKEL24030SDGME	590	adj glides	standard metal
	20 x 33	24 x 36	1	BXKEL24036SDGME	620	adj glides	standard metal
	20 x 38	24 x 42	1	BXKEL24042SDGME	740	adj glides	standard metal
	26 x 33	30 x 36	1	BXKEL30036SDGME	650	adj glides	standard metal
	26 x 38	30 x 42	1	BXKEL30042SDGME	770	adj glides	standard metal
	33 x 38	36 x 42	1	BXKEL36042SDGME	780	adj glides	standard metal
	20 x 26	24 x 30	1	BXKEL24030SDCME	670	2" black hard casters	standard metal
	20 x 33	24 x 36	1	BXKEL24036SDCME	700	2" black hard casters	standard metal
	20 x 38	24 x 42	1	BXKEL24042SDCME	820	2" black hard casters	standard metal
	26 x 33	30 x 36	1	BXKEL30036SDCME	730	2" black hard casters	standard metal
	26 x 38	30 x 42	1	BXKEL30042SDCME	850	2" black hard casters	standard metal
	33 x 38	36 x 42	1	BXKEL36042SDCME	860	2" black hard casters	standard metal
	20 x 26	24 x 30	1	BXKEL24030SDSME	710	2" black soft casters	standard metal
	20 x 33	24 x 36	1	BXKEL24036SDSME	740	2" black soft casters	standard metal
	20 x 38	24 x 42	1	BXKEL24042SDSME	860	2" black soft casters	standard metal
	26 x 33	30 x 36	1	BXKEL30036SDSME	770	2" black soft casters	standard metal
	26 x 38	30 x 42	1	BXKEL30042SDSME	890	2" black soft casters	standard metal
	33 x 38	36 x 42	1	BXKEL36042SDSME	900	2" black soft casters	standard metal
	20 x 26	24 x 30	1	BXKEL24030SDGPO	720	adj glides	polished
	20 x 33	24 x 36	1	BXKEL24036SDGPO	740	adj glides	polished
	20 x 38	24 x 42	1	BXKEL24042SDGPO	820	adj glides	polished
	26 x 33	30 x 36	1	BXKEL30036SDGPO	780	adj glides	polished
	26 x 38	30 x 42	1	BXKEL30042SDGPO	870	adj glides	polished
	33 x 38	36 x 42	1	BXKEL36042SDGPO	880	adj glides	polished
	20 x 26	24 x 30	1	BXKEL24030SDCPO	800	2" black hard casters	polished
	20 x 33	24 x 36	1	BXKEL24036SDCPO	820	2" black hard casters	polished
	20 x 38	24 x 42	1	BXKEL24042SDCPO	900	2" black hard casters	polished
	26 x 33	30 x 36	1	BXKEL30036SDCPO	860	2" black hard casters	polished
	26 x 38	30 x 42	1	BXKEL30042SDCPO	950	2" black hard casters	polished
	33 x 38	36 x 42	1	BXKEL36042SDCPO	960	2" black hard casters	polished
20 x 26	24 x 30	1	BXKEL24030SDSPO	840	2" black soft casters	polished	
20 x 33	24 x 36	1	BXKEL24036SDSPO	860	2" black soft casters	polished	
20 x 38	24 x 42	1	BXKEL24042SDSPO	940	2" black soft casters	polished	
26 x 33	30 x 36	1	BXKEL30036SDSPO	900	2" black soft casters	polished	
26 x 38	30 x 42	1	BXKEL30042SDSPO	990	2" black soft casters	polished	
33 x 38	36 x 42	1	BXKEL36042SDSPO	1,000	2" black soft casters	polished	

**C casters**

2" black dual wheel locking hard casters (for carpet)

**S casters**

2" black dual wheel locking soft casters (for hard floors)



**Standard metal powder coat finishes (ME)**

Black Wrinkle, Chateau Brown Wrinkle, Flat Black, Furniture White, Inner Tone, Light Tone, Medium Tone and Metallic Silver

**Premium Polished Finish (PO)**

Polished Aluminum/Steel

Power module cone shaped top plate - #OBXWMPCC \$350 list

metal cone-shaped top plate conceals and protects center mounted power module in surface.

Concealed wires exit down inside the base column and out at the bottom of the base column.

Available for single column Keller X bases

Note that the cone cannot be made with the polished finish, black or white paint is available for the cone with a polished base. The Circo power unit can be used with this cone wire manager.



Wire management hole set (2) in column - #OBTWMH2G \$50 list

each hole is 1.25" x 2.25". Removeable grommets narrows hole to 1.25" diameter

Available for single column Keller X bases

Note that the wire management grommet cannot be made with the polished finish

# bases

X fixed

Ria

base	base dim.	max top support	base qty	base set model no.	list	glides or casters	finish
Ria 	27.75"H X	20 x 20 24 x 24, 24 rd	1	BXRIA24024SDGME	500	adj glides	standard metal
		26 x 26 30 x 30, 36 rd	1	BXRIA30030SDGME	550	adj glides	standard metal
		33 x 33 36 x 36, 42 rd	1	BXRIA36036SDGME	630	adj glides	standard metal
		38 x 38 42 x 42, 48 rd	1	BXRIA42042SDGME	750	adj glides	standard metal
	20 x 20 24 x 24, 24 rd	1	BXRIA24024SDCME	580	2" black hard casters	standard metal	
	26 x 26 30 x 30, 36 rd	1	BXRIA30030SDCME	630	2" black hard casters	standard metal	
	33 x 33 36 x 36, 42 rd	1	BXRIA36036SDCME	710	2" black hard casters	standard metal	
	38 x 38 42 x 42, 48 rd	1	BXRIA42042SDCME	830	2" black hard casters	standard metal	
	20 x 20 24 x 24, 24 rd	1	BXRIA24024SDSME	620	2" black soft casters	standard metal	
	26 x 26 30 x 30, 36 rd	1	BXRIA30030SDSME	670	2" black soft casters	standard metal	
	33 x 33 36 x 36, 42 rd	1	BXRIA36036SDSME	750	2" black soft casters	standard metal	
	38 x 38 42 x 42, 48 rd	1	BXRIA42042SDSME	870	2" black soft casters	standard metal	
	20 x 20 24 x 24, 24 rd	1	BXRIA24024SDGPO	600	adj glides	polished	
	26 x 26 30 x 30, 36 rd	1	BXRIA30030SDGPO	640	adj glides	polished	
	33 x 33 36 x 36, 42 rd	1	BXRIA36036SDGPO	720	adj glides	polished	
	38 x 38 42 x 42, 48 rd	1	BXRIA42042SDGPO	830	adj glides	polished	
	20 x 20 24 x 24, 24 rd	1	BXRIA24024SDCPO	680	2" black hard casters	polished	
	26 x 26 30 x 30, 36 rd	1	BXRIA30030SDCPO	720	2" black hard casters	polished	
	33 x 33 36 x 36, 42 rd	1	BXRIA36036SDCPO	800	2" black hard casters	polished	
	38 x 38 42 x 42, 48 rd	1	BXRIA42042SDCPO	910	2" black hard casters	polished	
	20 x 20 24 x 24, 24 rd	1	BXRIA24024SDSPO	720	2" black soft casters	polished	
	26 x 26 30 x 30, 36 rd	1	BXRIA30030SDSPO	760	2" black soft casters	polished	
	33 x 33 36 x 36, 42 rd	1	BXRIA36036SDSPO	840	2" black soft casters	polished	
	38 x 38 42 x 42, 48 rd	1	BXRIA42042SDSPO	950	2" black soft casters	polished	

For complete custom lower height or custom higher height base model number:

1. Insert height selection:

**SB** bar height (40.75"H)

**SH** custom Higher fixed height - specify height

**SL** custom Lower fixed height - specify height

bar or custom height	base dim.	max top support	base qty	base set model no.	list	glides or casters	finish
	27.75"H X	20 x 20 24 x 24, 24 rd	1	BXRIA24024__GME	590	adj glides	standard metal
		26 x 26 30 x 30, 36 rd	1	BXRIA30030__GME	640	adj glides	standard metal
		33 x 33 36 x 36, 42 rd	1	BXRIA36036__GME	720	adj glides	standard metal
		38 x 38 42 x 42, 48 rd	1	BXRIA42042__GME	840	adj glides	standard metal
	20 x 20 24 x 24, 24 rd	1	BXRIA24024__CME	670	2" black hard casters	standard metal	
	26 x 26 30 x 30, 36 rd	1	BXRIA30030__CME	720	2" black hard casters	standard metal	
	33 x 33 36 x 36, 42 rd	1	BXRIA36036__CME	800	2" black hard casters	standard metal	
	38 x 38 42 x 42, 48 rd	1	BXRIA42042__CME	920	2" black hard casters	standard metal	
	20 x 20 24 x 24, 24 rd	1	BXRIA24024__SME	710	2" black soft casters	standard metal	
	26 x 26 30 x 30, 36 rd	1	BXRIA30030__SME	760	2" black soft casters	standard metal	
	33 x 33 36 x 36, 42 rd	1	BXRIA36036__SME	840	2" black soft casters	standard metal	
	38 x 38 42 x 42, 48 rd	1	BXRIA42042__SME	960	2" black soft casters	standard metal	
	20 x 20 24 x 24, 24 rd	1	BXRIA24024__GPO	690	adj glides	polished	
	26 x 26 30 x 30, 36 rd	1	BXRIA30030__GPO	730	adj glides	polished	
	33 x 33 36 x 36, 42 rd	1	BXRIA36036__GPO	810	adj glides	polished	
	38 x 38 42 x 42, 48 rd	1	BXRIA42042__GPO	920	adj glides	polished	
	20 x 20 24 x 24, 24 rd	1	BXRIA24024__CPO	770	2" black hard casters	polished	
	26 x 26 30 x 30, 36 rd	1	BXRIA30030__CPO	810	2" black hard casters	polished	
	33 x 33 36 x 36, 42 rd	1	BXRIA36036__CPO	890	2" black hard casters	polished	
	38 x 38 42 x 42, 48 rd	1	BXRIA42042__CPO	1,000	2" black hard casters	polished	
	20 x 20 24 x 24, 24 rd	1	BXRIA24024__SPO	810	2" black soft casters	polished	
	26 x 26 30 x 30, 36 rd	1	BXRIA30030__SPO	850	2" black soft casters	polished	
	33 x 33 36 x 36, 42 rd	1	BXRIA36036__SPO	930	2" black soft casters	polished	
	38 x 38 42 x 42, 48 rd	1	BXRIA42042__SPO	1,040	2" black soft casters	polished	

**C casters**

2" black dual wheel locking hard casters (for carpet)

**S casters**

2" black dual wheel locking soft casters (for hard floors)

**Standard metal powder coat finishes (ME)**

Black Wrinkle, Chateau Brown Wrinkle, Flat Black, Furniture White, Inner Tone, Light Tone, Medium Tone and Metallic Silver

**Premium Polished Finish (PO)**

Polished Aluminum/Steel

# bases

offset X fixed

Ria

base	base dim.	max top support	base qty	base set model no.	list	glides or casters	finish
Ria 	27.75"H offset X	20 x 26 24 x 30	1	BXRIA24030SDGME	530	adj glides	standard metal
		20 x 33 24 x 36	1	BXRIA24036SDGME	580	adj glides	standard metal
		20 x 38 24 x 42	1	BXRIA24042SDGME	660	adj glides	standard metal
		26 x 33 30 x 36	1	BXRIA30036SDGME	600	adj glides	standard metal
	26 x 38 30 x 42	1	BXRIA30042SDGME	670	adj glides	standard metal	
	33 x 38 36 x 42	1	BXRIA36042SDGME	690	adj glides	standard metal	
	20 x 26 24 x 30	1	BXRIA24030SDCME	610	2" black hard casters	standard metal	
	20 x 33 24 x 36	1	BXRIA24036SDCME	660	2" black hard casters	standard metal	
	20 x 38 24 x 42	1	BXRIA24042SDCME	740	2" black hard casters	standard metal	
	26 x 33 30 x 36	1	BXRIA30036SDCME	680	2" black hard casters	standard metal	
	26 x 38 30 x 42	1	BXRIA30042SDCME	750	2" black hard casters	standard metal	
	33 x 38 36 x 42	1	BXRIA36042SDCME	770	2" black hard casters	standard metal	
	20 x 26 24 x 30	1	BXRIA24030SDSME	650	2" black soft casters	standard metal	
	20 x 33 24 x 36	1	BXRIA24036SDSME	700	2" black soft casters	standard metal	
	20 x 38 24 x 42	1	BXRIA24042SDSME	780	2" black soft casters	standard metal	
	26 x 33 30 x 36	1	BXRIA30036SDSME	720	2" black soft casters	standard metal	
	26 x 38 30 x 42	1	BXRIA30042SDSME	790	2" black soft casters	standard metal	
	33 x 38 36 x 42	1	BXRIA36042SDSME	810	2" black soft casters	standard metal	
	20 x 26 24 x 30	1	BXRIA24030SDGPO	640	adj glides	polished	
	20 x 33 24 x 36	1	BXRIA24036SDGPO	690	adj glides	polished	
	20 x 38 24 x 42	1	BXRIA24042SDGPO	770	adj glides	polished	
	26 x 33 30 x 36	1	BXRIA30036SDGPO	710	adj glides	polished	
	26 x 38 30 x 42	1	BXRIA30042SDGPO	780	adj glides	polished	
	33 x 38 36 x 42	1	BXRIA36042SDGPO	800	adj glides	polished	
	20 x 26 24 x 30	1	BXRIA24030SDCPO	720	2" black hard casters	polished	
	20 x 33 24 x 36	1	BXRIA24036SDCPO	770	2" black hard casters	polished	
	20 x 38 24 x 42	1	BXRIA24042SDCPO	850	2" black hard casters	polished	
	26 x 33 30 x 36	1	BXRIA30036SDCPO	790	2" black hard casters	polished	
	26 x 38 30 x 42	1	BXRIA30042SDCPO	860	2" black hard casters	polished	
	33 x 38 36 x 42	1	BXRIA36042SDCPO	880	2" black hard casters	polished	
	20 x 26 24 x 30	1	BXRIA24030SDSPO	760	2" black soft casters	polished	
	20 x 33 24 x 36	1	BXRIA24036SDSPO	810	2" black soft casters	polished	
	20 x 38 24 x 42	1	BXRIA24042SDSPO	890	2" black soft casters	polished	
	26 x 33 30 x 36	1	BXRIA30036SDSPO	830	2" black soft casters	polished	
	26 x 38 30 x 42	1	BXRIA30042SDSPO	900	2" black soft casters	polished	
	33 x 38 36 x 42	1	BXRIA36042SDSPO	920	2" black soft casters	polished	

**C casters**

2" black dual wheel locking hard casters (for carpet)

**S casters**

2" black dual wheel locking soft casters (for hard floors)

**Standard metal powder coat finishes (ME)**

Black Wrinkle, Chateau Brown Wrinkle, Flat Black, Furniture White, Inner Tone, Light Tone, Medium Tone and Metallic Silver

**Premium Polished Finish (PO)**

Polished Aluminum/Steel

Power module cone shaped top plate - #OBXWMPCC \$350 list

metal cone-shaped top plate conceals and protects center mounted power module in surface.

Concealed wires exit down inside the base column and out at the bottom of the base column.

Available for single column Ria X bases

Note that the cone cannot be made with the polished finish, black or white paint is available for the cone with a polished base. The Circo power unit can be used with this cone wire manager.

Wire management hole set (2) in column - #OBTWMH2G \$50 list

each hole is 1.25" x 2.25". Removeable grommets narrows hole to 1.25" diameter

Available for single column Ria X bases

Note that the wire management grommet cannot be made with the polished finish

bases  
X fixed  
Novi

base	base dim.	max top support	base qty	base model no.	list	glides or casters	finish	
Novi 	27.75"H X	22 x 22	24 x 24, 24 rd	1	BXNOV24024SDGME	500	adj glides	standard metal
		26 x 26	30 x 30, 36 rd	1	BXNOV30030SDGME	510	adj glides	standard metal
		32 x 32	36 x 36, 42 rd	1	BXNOV36036SDGME	570	adj glides	standard metal
		38 x 38	42 x 42, 48 rd	1	BXNOV42042SDGME	640	adj glides	standard metal
	22 x 22	24 x 24, 24 rd	1	BXNOV24024SDCME	580	2" black locking casters	standard metal	
	26 x 26	30 x 30, 36 rd	1	BXNOV30030SDCME	590	2" black locking casters	standard metal	
	32 x 32	36 x 36, 42 rd	1	BXNOV36036SDCME	660	2" black locking casters	standard metal	
	38 x 38	42 x 42, 48 rd	1	BXNOV42042SDCME	730	2" black locking casters	standard metal	
	22 x 22	24 x 24, 24 rd	1	BXNOV24024SDGPC	720	adj glides	polished	
	26 x 26	30 x 30, 36 rd	1	BXNOV30030SDGPC	730	adj glides	polished	
	32 x 32	36 x 36, 42 rd	1	BXNOV36036SDGPC	790	adj glides	polished	
	38 x 38	42 x 42, 48 rd	1	BXNOV42042SDGPC	860	adj glides	polished	
40.75"H X	22 x 22	24 x 24, 24 rd	1	BXNOV24024SDCPC	800	2" black locking casters	polished	
		26 x 26	30 x 30, 36 rd	1	BXNOV30030SDCPC	810	2" black locking casters	polished
		32 x 32	36 x 36, 42 rd	1	BXNOV36036SDCPC	880	2" black locking casters	polished
		38 x 38	42 x 42, 48 rd	1	BXNOV42042SDCPC	950	2" black locking casters	polished
	26 x 26	30 x 30, 36 rd	1	BXNOV30030SBCME	670	2" black locking casters	standard metal	
		32 x 32	36 x 36, 42 rd	1	BXNOV36036SBCME	750	2" black locking casters	standard metal
		38 x 38	42 x 42, 48 rd	1	BXNOV42042SBCME	810	2" black locking casters	standard metal
		22 x 22	24 x 24, 24 rd	1	BXNOV24024SBCPC	800	adj glides	polished
	26 x 26	30 x 30, 36 rd	1	BXNOV30030SBCPC	810	adj glides	polished	
		32 x 32	36 x 36, 42 rd	1	BXNOV36036SBCPC	880	adj glides	polished
		38 x 38	42 x 42, 48 rd	1	BXNOV42042SBCPC	950	adj glides	polished
		22 x 22	24 x 24, 24 rd	1	BXNOV24024SBCPO	890	2" black locking casters	polished
	26 x 26	30 x 30, 36 rd	1	BXNOV30030SBCPO	900	2" black locking casters	polished	
		32 x 32	36 x 36, 42 rd	1	BXNOV36036SBCPC	970	2" black locking casters	polished
		38 x 38	42 x 42, 48 rd	1	BXNOV42042SBCPC	1,030	2" black locking casters	polished



**Casters (C)**  
2" black dual wheel locking

**Standard metal powder coat finishes (ME)**  
Black Wrinkle, Chateau Brown Wrinkle, Flat Black, Furniture White, Inner Tone, Light Tone, Medium Tone and Metallic Silver

**Premium Polished Finish (PC)**  
Polished Chrome

bases  
X fixed  
Novi

base	base dim.	max top support	base qty	base model no.	list	glides or casters	finish	
Novi custom height X 	Novi custom height X	22 x 22	24 x 24, 24 rd	1	BXNOV24024__GME	580	adj glides	standard metal
		26 x 26	30 x 30, 36 rd	1	BXNOV30030__GME	590	adj glides	standard metal
		32 x 32	36 x 36, 42 rd	1	BXNOV36036__GME	660	adj glides	standard metal
		38 x 38	42 x 42, 48 rd	1	BXNOV42042__GME	730	adj glides	standard metal
	22 x 22	24 x 24, 24 rd	1	BXNOV24024__CME	670	2" black locking casters	standard metal	
	26 x 26	30 x 30, 36 rd	1	BXNOV30030__CME	680	2" black locking casters	standard metal	
	32 x 32	36 x 36, 42 rd	1	BXNOV36036__CME	750	2" black locking casters	standard metal	
	38 x 38	42 x 42, 48 rd	1	BXNOV42042__CME	810	2" black locking casters	standard metal	
	22 x 22	24 x 24, 24 rd	1	BXNOV24024__GPC	800	adj glides	polished	
	26 x 26	30 x 30, 36 rd	1	BXNOV30030__GPC	810	adj glides	polished	
	32 x 32	36 x 36, 42 rd	1	BXNOV36036__GPC	880	adj glides	polished	
	38 x 38	42 x 42, 48 rd	1	BXNOV42042__GPC	950	adj glides	polished	
Novi 27.75"H offset X	Novi 27.75"H offset X	22 x 22	24 x 24, 24 rd	1	BXNOV24024__CPC	890	2" black locking casters	polished
		26 x 26	30 x 30, 36 rd	1	BXNOV30030__CPC	900	2" black locking casters	polished
		32 x 32	36 x 36, 42 rd	1	BXNOV36036__CPC	970	2" black locking casters	polished
		38 x 38	42 x 42, 48 rd	1	BXNOV42042__CPC	1,030	2" black locking casters	polished
	22 x 26	24 x 30	1	BXNOV24030SDGME	510	adj glides	standard metal	
		26 x 36	30 x 42	1	BXNOV30042SDGME	560	adj glides	standard metal
		22 x 26	24 x 30	1	BXNOV24030SDCME	590	2" black locking casters	standard metal
		26 x 36	30 x 42	1	BXNOV30042SDCME	650	2" black locking casters	standard metal
	22 x 26	24 x 30	1	BXNOV24030SDGPC	730	adj glides	polished	
		26 x 36	30 x 42	1	BXNOV30042SDGPC	780	adj glides	polished
		22 x 26	24 x 30	1	BXNOV24030SDCPC	810	2" black locking casters	polished
		26 x 36	30 x 42	1	BXNOV30042SDCPC	870	2" black locking casters	polished



**Casters (C)**  
2" black dual wheel locking

**Standard metal powder coat finishes (ME)**  
Black Wrinkle, Chateau Brown Wrinkle, Flat Black, Furniture White, Inner Tone, Light Tone, Medium Tone and Metallic Silver

**Premium Polished Finish (PC)**  
Polished Chrome

# bases

## X fixed

### Moto

base	base dim.	max top support	base qty	base model no.	list	glides or casters	finish		
Moto 	27.75"H X	22 x 22	24 x 24, 30 rd	1	BXMOT24024SDGME	660	adj glides	standard metal	
		26 x 26	30 x 30, 36 rd	1	BXMOT30030SDGME	700	adj glides	standard metal	
		32 x 32	36 x 36, 42 rd	1	BXMOT36036SDGME	760	adj glides	standard metal	
		36 x 36	42 x 42, 48 rd	1	BXMOT42042SDGME	780	adj glides	standard metal	
	40.75"H X	22 x 22	24 x 24, 30 rd	1	BXMOT24024SDCME	750	2" black locking casters	standard metal	
			26 x 26	30 x 30, 36 rd	1	BXMOT30030SDCME	790	2" black locking casters	standard metal
			32 x 32	36 x 36, 42 rd	1	BXMOT36036SDCME	850	2" black locking casters	standard metal
			36 x 36	42 x 42, 48 rd	1	BXMOT42042SDCME	870	2" black locking casters	standard metal
		22 x 22	24 x 24, 30 rd	1	BXMOT24024SDPME	790	2" premium locking casters	standard metal	
			26 x 26	30 x 30, 36 rd	1	BXMOT30030SDPME	840	2" premium locking casters	standard metal
			32 x 32	36 x 36, 42 rd	1	BXMOT36036SDPME	890	2" premium locking casters	standard metal
			36 x 36	42 x 42, 48 rd	1	BXMOT42042SDPME	910	2" premium locking casters	standard metal
custom higher height X (specify height)		22 x 22	24 x 24, 30 rd	1	BXMOT24024SBCME	750	adj glides	standard metal	
			26 x 26	30 x 30, 36 rd	1	BXMOT30030SBCME	790	adj glides	standard metal
			32 x 32	36 x 36, 42 rd	1	BXMOT36036SBCME	850	adj glides	standard metal
			36 x 36	42 x 42, 48 rd	1	BXMOT42042SBCME	870	adj glides	standard metal
	22 x 22	24 x 24, 30 rd	1	BXMOT24024SBCME	840	2" black locking casters	standard metal		
		26 x 26	30 x 30, 36 rd	1	BXMOT30030SBCME	880	2" black locking casters	standard metal	
		32 x 32	36 x 36, 42 rd	1	BXMOT36036SBCME	940	2" black locking casters	standard metal	
		36 x 36	42 x 42, 48 rd	1	BXMOT42042SBCME	960	2" black locking casters	standard metal	
	22 x 22	24 x 24, 30 rd	1	BXMOT24024SBPME	880	2" premium locking casters	standard metal		
		26 x 26	30 x 30, 36 rd	1	BXMOT30030SBPME	920	2" premium locking casters	standard metal	
		32 x 32	36 x 36, 42 rd	1	BXMOT36036SBPME	980	2" premium locking casters	standard metal	
		36 x 36	42 x 42, 48 rd	1	BXMOT42042SBPME	1,000	2" premium locking casters	standard metal	
custom lower height X (specify height)	22 x 22	24 x 24, 30 rd	1	BXMOT24024SHGME	750	adj glides	standard metal		
		26 x 26	30 x 30, 36 rd	1	BXMOT30030SHGME	790	adj glides	standard metal	
		32 x 32	36 x 36, 42 rd	1	BXMOT36036SHGME	850	adj glides	standard metal	
		36 x 36	42 x 42, 48 rd	1	BXMOT42042SHGME	870	adj glides	standard metal	
	22 x 22	24 x 24, 30 rd	1	BXMOT24024SHCME	840	2" black locking casters	standard metal		
		26 x 26	30 x 30, 36 rd	1	BXMOT30030SHCME	880	2" black locking casters	standard metal	
		32 x 32	36 x 36, 42 rd	1	BXMOT36036SHCME	940	2" black locking casters	standard metal	
		36 x 36	42 x 42, 48 rd	1	BXMOT42042SHCME	960	2" black locking casters	standard metal	
	22 x 22	24 x 24, 30 rd	1	BXMOT24024SHPME	880	2" premium locking casters	standard metal		
		26 x 26	30 x 30, 36 rd	1	BXMOT30030SHPME	920	2" premium locking casters	standard metal	
		32 x 32	36 x 36, 42 rd	1	BXMOT36036SHPME	980	2" premium locking casters	standard metal	
		36 x 36	42 x 42, 48 rd	1	BXMOT42042SHPME	1,000	2" premium locking casters	standard metal	
22 x 22	24 x 24, 30 rd	1	BXMOT24024SLGME	750	adj glides	standard metal			
	26 x 26	30 x 30, 36 rd	1	BXMOT30030SLGME	790	adj glides	standard metal		
	32 x 32	36 x 36, 42 rd	1	BXMOT36036SLGME	850	adj glides	standard metal		
	36 x 36	42 x 42, 48 rd	1	BXMOT42042SLGME	870	adj glides	standard metal		
22 x 22	24 x 24, 30 rd	1	BXMOT24024SLCME	840	2" black locking casters	standard metal			
	26 x 26	30 x 30, 36 rd	1	BXMOT30030SLCME	880	2" black locking casters	standard metal		
	32 x 32	36 x 36, 42 rd	1	BXMOT36036SLCME	940	2" black locking casters	standard metal		
	36 x 36	42 x 42, 48 rd	1	BXMOT42042SLCME	960	2" black locking casters	standard metal		
22 x 22	24 x 24, 30 rd	1	BXMOT24024SLPME	880	2" premium locking casters	standard metal			
	26 x 26	30 x 30, 36 rd	1	BXMOT30030SLPME	920	2" premium locking casters	standard metal		
	32 x 32	36 x 36, 42 rd	1	BXMOT36036SLPME	980	2" premium locking casters	standard metal		
	36 x 36	42 x 42, 48 rd	1	BXMOT42042SLPME	1,000	2" premium locking casters	standard metal		



**Casters (C)**  
2" black dual wheel locking

**Standard metal powder coat finishes (ME)**  
Black Wrinkle, Chateau Brown Wrinkle, Flat Black, Furniture White, Inner Tone, Light Tone, Medium Tone and Metallic Silver



**Premium Casters (P)**  
2" silver/black dual wheel locking

# bases

## X fixed

### Zoey

base	base dim.	max top support	base qty	base model no.	list	glides or casters	finish		
Zoey 	27.75"H X	21 x 21	24 x 24, 24 rd	1	BXZOE24024SDGME	620	adj glides	standard metal	
		27 x 27	30 x 30, 36 rd	1	BXZOE30030SDGME	650	adj glides	standard metal	
		33 x 33	36 x 36, 42 rd	1	BXZOE36036SDGME	690	adj glides	standard metal	
		21 x 21	24 x 24, 24 rd	1	BXZOE24024SDCME	700	3" black locking casters	standard metal	
	40.75"H X	27 x 27	30 x 30, 36 rd	1	BXZOE30030SDCME	740	3" black locking casters	standard metal	
		33 x 33	36 x 36, 42 rd	1	BXZOE36036SDCME	780	3" black locking casters	standard metal	
		21 x 21	24 x 24, 24 rd	1	BXZOE24024SDPME	750	3" premium locking casters	standard metal	
		27 x 27	30 x 30, 36 rd	1	BXZOE30030SDPME	780	3" premium locking casters	standard metal	
	27.75"H offset X	21 x 21	24 x 24, 24 rd	1	BXZOE24024SBGME	700	adj glides	standard metal	
			27 x 27	30 x 30, 36 rd	1	BXZOE30030SBGME	740	adj glides	standard metal
			33 x 33	36 x 36, 42 rd	1	BXZOE36036SBGME	780	adj glides	standard metal
			21 x 21	24 x 24, 24 rd	1	BXZOE24024SBCME	790	3" black locking casters	standard metal
21 x 21		24 x 24, 24 rd	1	BXZOE24024SBCME	830	3" black locking casters	standard metal		
		27 x 27	30 x 30, 36 rd	1	BXZOE30030SBCME	870	3" black locking casters	standard metal	
		33 x 33	36 x 36, 42 rd	1	BXZOE36036SBCME	910	3" black locking casters	standard metal	
		21 x 21	24 x 24, 24 rd	1	BXZOE24024SBPME	840	3" premium locking casters	standard metal	
21 x 21		24 x 24, 24 rd	1	BXZOE24024SBPME	870	3" premium locking casters	standard metal		
		27 x 27	30 x 30, 36 rd	1	BXZOE30030SBPME	910	3" premium locking casters	standard metal	
		33 x 33	36 x 36, 42 rd	1	BXZOE36036SBPME	950	3" premium locking casters	standard metal	
		21 x 21	24 x 24, 24 rd	1	BXZOE24030SDGME	550	adj glides	standard metal	
27.75"H offset X	27 x 33	30 x 36	1	BXZOE30036SDGME	560	adj glides	standard metal		
	21 x 27	24 x 30	1	BXZOE24030SDCME	640	3" black locking casters	standard metal		
	27 x 33	30 x 36	1	BXZOE30036SDCME	650	3" black locking casters	standard metal		
	21 x 27	24 x 30	1	BXZOE24030SDPME	680	3" premium locking casters	standard metal		
27.75"H offset X	27 x 33	30 x 36	1	BXZOE30036SDPME	690	3" premium locking casters	standard metal		

For complete custom lower height or custom higher height base model number:

1. Insert height selection:

SH custom Higher fixed height - specify height

SL custom Lower fixed height - specify height

custom height X	21 x 21	24 x 24, 24 rd	1	BXZOE24024__GME	700	adj glides	standard metal
	27 x 27	30 x 30, 36 rd	1	BXZOE30030__GME	740	adj glides	standard metal
	33 x 33	36 x 36, 42 rd	1	BXZOE36036__GME	780	adj glides	standard metal
	21 x 21	24 x 24, 24 rd	1	BXZOE24024__CME	790	3" black locking casters	standard metal
	27 x 27	30 x 30, 36 rd	1	BXZOE30030__CME	830	3" black locking casters	standard metal
	33 x 33	36 x 36, 42 rd	1	BXZOE36036__CME	870	3" black locking casters	standard metal
	21 x 21	24 x 24, 24 rd	1	BXZOE24024__PME	840	3" premium locking casters	standard metal
	27 x 27	30 x 30, 36 rd	1	BXZOE30030__PME	870	3" premium locking casters	standard metal
	33 x 33	36 x 36, 42 rd	1	BXZOE36036__PME	910	3" premium locking casters	standard metal





**Casters (C)**  
3" black dual wheel locking

**Standard metal powder coat finishes (ME)**  
Black Wrinkle, Chateau Brown Wrinkle, Flat Black, Furniture White, Inner Tone, Light Tone, Medium Tone and Metallic Silver



**Premium Casters (P)**  
3" white dual wheel locking

bases  
X flip  
Keller, Ria

base	base dim.	max top support	base qty	base model no.	list	glides or casters	finish
Keller flip X 	20 x 20	24 x 24, 24 rd	1	BXKEL24024FDGME	820	adj glides	standard metal
	26 x 26	30 x 30, 36 rd	1	BXKEL30030FDGME	880	adj glides	standard metal
	33 x 33	36 x 36, 42 rd	1	BXKEL36036FDGME	950	adj glides	standard metal
	38 x 38	42 x 42, 48 rd	1	BXKEL42042FDGME	1,070	adj glides	standard metal
	20 x 20	24 x 24, 24 rd	1	BXKEL24024FDCME	900	2" black hard casters	standard metal
	26 x 26	30 x 30, 36 rd	1	BXKEL30030FDCME	960	2" black hard casters	standard metal
	33 x 33	36 x 36, 42 rd	1	BXKEL36036FDCME	1,030	2" black hard casters	standard metal
	38 x 38	42 x 42, 48 rd	1	BXKEL42042FDCME	1,150	2" black hard casters	standard metal
	20 x 20	24 x 24, 24 rd	1	BXKEL24024FDSME	940	2" black soft casters	standard metal
	26 x 26	30 x 30, 36 rd	1	BXKEL30030FDSME	1,000	2" black soft casters	standard metal
	33 x 33	36 x 36, 42 rd	1	BXKEL36036FDSME	1,070	2" black soft casters	standard metal
	38 x 38	42 x 42, 48 rd	1	BXKEL42042FDSME	1,190	2" black soft casters	standard metal
	20 x 20	24 x 24, 24 rd	1	BXKEL24024FDGPO	970	adj glides	polished
	26 x 26	30 x 30, 36 rd	1	BXKEL30030FDGPO	1,030	adj glides	polished
	33 x 33	36 x 36, 42 rd	1	BXKEL36036FDGPO	1,100	adj glides	polished
	38 x 38	42 x 42, 48 rd	1	BXKEL42042FDGPO	1,220	adj glides	polished
	20 x 20	24 x 24, 24 rd	1	BXKEL24024FDCPO	1,050	2" black hard casters	polished
	26 x 26	30 x 30, 36 rd	1	BXKEL30030FDCPO	1,110	2" black hard casters	polished
	33 x 33	36 x 36, 42 rd	1	BXKEL36036FDCPO	1,180	2" black hard casters	polished
	38 x 38	42 x 42, 48 rd	1	BXKEL42042FDCPO	1,300	2" black hard casters	polished
20 x 20	24 x 24, 24 rd	1	BXKEL24024FDSPO	1,090	2" black soft casters	polished	
26 x 26	30 x 30, 36 rd	1	BXKEL30030FDSPO	1,150	2" black soft casters	polished	
33 x 33	36 x 36, 42 rd	1	BXKEL36036FDSPO	1,220	2" black soft casters	polished	
38 x 38	42 x 42, 48 rd	1	BXKEL42042FDSPO	1,340	2" black soft casters	polished	
Ria flip X 	20 x 20	24 x 24, 24 rd	1	BXRIA24024FDGME	760	adj glides	standard metal
	26 x 26	30 x 30, 36 rd	1	BXRIA30030FDGME	820	adj glides	standard metal
	33 x 33	36 x 36, 42 rd	1	BXRIA36036FDGME	900	adj glides	standard metal
	38 x 38	42 x 42, 48 rd	1	BXRIA42042FDGME	1,020	adj glides	standard metal
	20 x 20	24 x 24, 24 rd	1	BXRIA24024FDCME	840	2" black hard casters	standard metal
	26 x 26	30 x 30, 36 rd	1	BXRIA30030FDCME	900	2" black hard casters	standard metal
	33 x 33	36 x 36, 42 rd	1	BXRIA36036FDCME	980	2" black hard casters	standard metal
	38 x 38	42 x 42, 48 rd	1	BXRIA42042FDCME	1,100	2" black hard casters	standard metal
	20 x 20	24 x 24, 24 rd	1	BXRIA24024FDSME	880	2" black soft casters	standard metal
	26 x 26	30 x 30, 36 rd	1	BXRIA30030FDSME	940	2" black soft casters	standard metal
	33 x 33	36 x 36, 42 rd	1	BXRIA36036FDSME	1,020	2" black soft casters	standard metal
	38 x 38	42 x 42, 48 rd	1	BXRIA42042FDSME	1,140	2" black soft casters	standard metal
	20 x 20	24 x 24, 24 rd	1	BXRIA24024FDGPO	870	adj glides	polished
	26 x 26	30 x 30, 36 rd	1	BXRIA30030FDGPO	920	adj glides	polished
	33 x 33	36 x 36, 42 rd	1	BXRIA36036FDGPO	1,010	adj glides	polished
	38 x 38	42 x 42, 48 rd	1	BXRIA42042FDGPO	1,130	adj glides	polished
	20 x 20	24 x 24, 24 rd	1	BXRIA24024FDCPO	950	2" black hard casters	polished
	26 x 26	30 x 30, 36 rd	1	BXRIA30030FDCPO	1,000	2" black hard casters	polished
	33 x 33	36 x 36, 42 rd	1	BXRIA36036FDCPO	1,090	2" black hard casters	polished
	38 x 38	42 x 42, 48 rd	1	BXRIA42042FDCPO	1,210	2" black hard casters	polished
20 x 20	24 x 24, 24 rd	1	BXRIA24024FDSPO	990	2" black soft casters	polished	
26 x 26	30 x 30, 36 rd	1	BXRIA30030FDSPO	1,040	2" black soft casters	polished	
33 x 33	36 x 36, 42 rd	1	BXRIA36036FDSPO	1,130	2" black soft casters	polished	
38 x 38	42 x 42, 48 rd	1	BXRIA42042FDSPO	1,250	2" black soft casters	polished	

**C casters**  
2" black dual wheel locking hard casters (for carpet)

**S casters (Keller & Ria)**  
2" black dual wheel locking soft casters (for hard floors)

**Standard metal powder coat finishes (ME):**  
Black Wrinkle, Chateau Brown Wrinkle, Flat Black, Furniture White, Inner Tone, Light Tone, Medium Tone, and Metallic Silver

**Premium Polished Finishes:**  
PO Polished Aluminum/steel (Keller + Ria)

bases  
nesting flip X, nesting flip offset X  
Ria

base	base dim.	max top support	base qty	base model no.	list	glides or casters	finish
Ria nesting flip X 	20 x 20	24 x 24, 24 rd	1	BXRIA24024NEGME	950	adj glides	standard metal
	26 x 26	30 x 30, 30 rd	1	BXRIA30030NEGME	1,010	adj glides	standard metal
	33 x 33	36 x 36, 36 rd	1	BXRIA36036NEGME	1,090	adj glides	standard metal
	33 x 33	42 rd only	1	BXRIA42000NEGME	1,120	adj glides	standard metal
	20 x 20	24 x 24, 24 rd	1	BXRIA24024NECME	1,030	2" black hard casters	standard metal
	26 x 26	30 x 30, 30 rd	1	BXRIA30030NECME	1,090	2" black hard casters	standard metal
	33 x 33	36 x 36, 36 rd	1	BXRIA36036NECME	1,170	2" black hard casters	standard metal
	33 x 33	42 rd only	1	BXRIA42000NECME	1,200	2" black hard casters	standard metal
	20 x 20	24 x 24, 24 rd	1	BXRIA24024NESME	1,070	2" black soft casters	standard metal
	26 x 26	30 x 30, 30 rd	1	BXRIA30030NESME	1,130	2" black soft casters	standard metal
	33 x 33	36 x 36, 36 rd	1	BXRIA36036NESME	1,210	2" black soft casters	standard metal
	33 x 33	42 rd only	1	BXRIA42000NESME	1,240	2" black soft casters	standard metal
	20 x 20	24 x 24, 24 rd	1	BXRIA24024NEGPO	1,060	adj glides	polished
	26 x 26	30 x 30, 30 rd	1	BXRIA30030NEGPO	1,120	adj glides	polished
	33 x 33	36 x 36, 36 rd	1	BXRIA36036NEGPO	1,200	adj glides	polished
	33 x 33	42 rd only	1	BXRIA42000NEGPO	1,230	adj glides	polished
	20 x 20	24 x 24, 24 rd	1	BXRIA24024NECPO	1,140	2" black hard casters	polished
	26 x 26	30 x 30, 30 rd	1	BXRIA30030NECPO	1,200	2" black hard casters	polished
	33 x 33	36 x 36, 36 rd	1	BXRIA36036NECPO	1,280	2" black hard casters	polished
	33 x 33	42 rd only	1	BXRIA42000NECPO	1,310	2" black hard casters	polished
20 x 20	24 x 24, 24 rd	1	BXRIA24024NESPO	1,180	2" black soft casters	polished	
26 x 26	30 x 30, 30 rd	1	BXRIA30030NESPO	1,240	2" black soft casters	polished	
33 x 33	36 x 36, 36 rd	1	BXRIA36036NESPO	1,320	2" black soft casters	polished	
33 x 33	42 rd only	1	BXRIA42000NESPO	1,350	2" black soft casters	polished	
nesting flip offset X	20 x 26	24 x 30	1	BXRIA24030NEGME	1,010	adj glides	standard metal
	20 x 33	24 x 36	1	BXRIA24036NEGME	1,090	adj glides	standard metal
	20 x 38	24 x 42	1	BXRIA24042NEGME	1,180	adj glides	standard metal
	20 x 26	24 x 30	1	BXRIA24030NECME	1,090	2" black hard casters	standard metal
	20 x 33	24 x 36	1	BXRIA24036NECME	1,170	2" black hard casters	standard metal
	20 x 38	24 x 42	1	BXRIA24042NECME	1,260	2" black hard casters	standard metal
	20 x 26	24 x 30	1	BXRIA24030NESME	1,130	2" black soft casters	standard metal
	20 x 33	24 x 36	1	BXRIA24036NESME	1,210	2" black soft casters	standard metal
	20 x 38	24 x 42	1	BXRIA24042NESME	1,300	2" black soft casters	standard metal
	20 x 26	24 x 30	1	BXRIA24030NEGPO	1,120	adj glides	polished
	20 x 33	24 x 36	1	BXRIA24036NEGPO	1,200	adj glides	polished
	20 x 38	24 x 42	1	BXRIA24042NEGPO	1,290	adj glides	polished
	20 x 26	24 x 30	1	BXRIA24030NECPO	1,200	2" black hard casters	polished
	20 x 33	24 x 36	1	BXRIA24036NECPO	1,280	2" black hard casters	polished
	20 x 38	24 x 42	1	BXRIA24042NECPO	1,370	2" black hard casters	polished
	20 x 26	24 x 30	1	BXRIA24030NESPO	1,240	2" black soft casters	polished
20 x 33	24 x 36	1	BXRIA24036NESPO	1,320	2" black soft casters	polished	
20 x 38	24 x 42	1	BXRIA24042NESPO	1,410	2" black soft casters	polished	

**C casters**  
2" black dual wheel locking hard casters (for carpet)



**S casters (Keller & Ria)**  
2" black dual wheel locking soft casters (for hard floors)

**Standard metal powder coat finishes (ME):**  
Black Wrinkle, Chateau Brown Wrinkle, Flat Black, Furniture White, Inner Tone, Light Tone, Medium Tone, and Metallic Silver

**Premium Polished Finishes:**  
PO Polished Aluminum/steel (Keller + Ria)

# bases

X flip  
Novi, Moto, Zoey

base	base dim.	max top support	base qty	base model no.	list	glides or casters	finish
Novi 	flip X 22 x 22 26 x 26 32 x 32	24 x 24, 24 rd 30 x 30, 36 rd 36 x 36, 42 rd	1 1 1	BXNOV24024FDGME	770	adj glides	standard metal
				BXNOV30030FDGME	830	adj glides	standard metal
				BXNOV36036FDGME	900	adj glides	standard metal
	22 x 22 26 x 26 32 x 32	24 x 24, 24 rd 30 x 30, 36 rd 36 x 36, 42 rd	1 1 1	BXNOV24024FDCME	860	2" black locking casters	standard metal
				BXNOV30030FDCME	910	2" black locking casters	standard metal
				BXNOV36036FDCME	990	2" black locking casters	standard metal
				BXNOV24024FDGPC	1,160	adj glides	polished
				BXNOV30030FDGPC	1,210	adj glides	polished
				BXNOV36036FDGPC	1,240	adj glides	polished
				BXNOV24024FDCPC	1,240	2" black locking casters	polished
				BXNOV30030FDCPC	1,290	2" black locking casters	polished
				BXNOV36036FDCPC	1,310	2" black locking casters	polished
Moto 	flip X 22 x 22 26 x 26 32 x 32	24 x 24, 30 rd 30 x 30, 36 rd 36 x 36, 42 rd	1 1 1	BXMOT24024FDGME	920	adj glides	standard metal
				BXMOT30030FDGME	980	adj glides	standard metal
				BXMOT36036FDGME	1,020	adj glides	standard metal
	22 x 22 26 x 26 32 x 32	24 x 24, 30 rd 30 x 30, 36 rd 36 x 36, 42 rd	1 1 1	BXMOT24024FDCME	1,010	2" black locking casters	standard metal
				BXMOT30030FDCME	1,070	2" black locking casters	standard metal
				BXMOT36036FDCME	1,110	2" black locking casters	standard metal
				BXMOT24024FDPME	1,060	2" premium locking casters	standard metal
				BXMOT30030FDPME	1,110	2" premium locking casters	standard metal
				BXMOT36036FDPME	1,160	2" premium locking casters	standard metal
Zoey 	flip X 21 x 21 27 x 27 33 x 33	24 x 24, 24 rd 30 x 30, 36 rd 36 x 36, 42 rd	1 1 1	BXZOE24024FDGME	860	adj glides	standard metal
				BXZOE30030FDGME	870	adj glides	standard metal
				BXZOE36036FDGME	930	adj glides	standard metal
	21 x 21 27 x 27 33 x 33	24 x 24, 24 rd 30 x 30, 36 rd 36 x 36, 42 rd	1 1 1	BXZOE24024FDCME	870	3" black locking casters	standard metal
				BXZOE30030FDCME	910	3" black locking casters	standard metal
				BXZOE36036FDCME	940	3" black locking casters	standard metal
				BXZOE24024FDPME	930	3" premium locking casters	standard metal
				BXZOE30030FDPME	950	3" premium locking casters	standard metal
				BXZOE36036FDPME	990	3" premium locking casters	standard metal

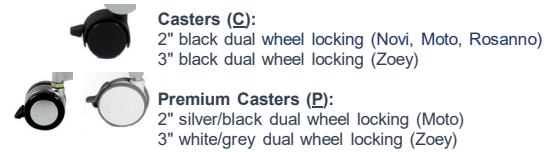





**Standard metal powder coat finishes (ME):**  
Black Wrinkle, Chateau Brown Wrinkle, Flat Black, Furniture White, Inner Tone, Light Tone, Medium Tone, and Metallic Silver

\*\* Note that the inner column of Moto height adjustable bases are only available in Flat Black, White or Metallic Silver. Note that Moto White is a shade off and a little creamier than Furniture White. The Moto Counter balance and Ratchet height adjustable bases inner and outer columns are only available in Flat Black, Moto White and Metallic Silver.

**Premium Polished Finishes:**  
PC Polished Chrome (Novi + Rosanno)

# bases

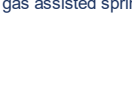
X adjustable height  
Keller, Ria, Novi, Moto

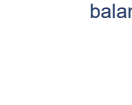
base	base dim.	max top support	base qty	base model no.	list	glides or casters	finish				
Keller 	spring clip X 20 x 20 26 x 26 33 x 33	24 x 24, 24 rd 30 x 30, 36 rd 36 x 36, 42 rd	1 1 1	BXKEL24024SSGME	780	adj glides	standard metal				
				BXKEL30030SSGME	830	adj glides	standard metal				
				BXKEL36036SSGME	910	adj glides	standard metal				
	20 x 20 26 x 26 33 x 33	24 x 24, 24 rd 30 x 30, 36 rd 36 x 36, 42 rd	1 1 1	BXKEL24024SSCME	860	2" black hard casters	standard metal				
				BXKEL30030SSCME	910	2" black hard casters	standard metal				
				BXKEL36036SSCME	990	2" black hard casters	standard metal				
				BXKEL24024SSSME	900	2" black soft casters	standard metal				
				BXKEL30030SSSME	950	2" black soft casters	standard metal				
				BXKEL36036SSSME	1,030	2" black soft casters	standard metal				
				Ria 	spring clip X 20 x 20 26 x 26 33 x 33	24 x 24, 24 rd 30 x 30, 36 rd 36 x 36, 42 rd	1 1 1	BXRIA24024SSGME	760	adj glides	standard metal
								BXRIA30030SSGME	820	adj glides	standard metal
								BXRIA36036SSGME	900	adj glides	standard metal
20 x 20 26 x 26 33 x 33	24 x 24, 24 rd 30 x 30, 36 rd 36 x 36, 42 rd	1 1 1	BXRIA24024SSCME		840	2" black hard casters	standard metal				
			BXRIA30030SSCME		900	2" black hard casters	standard metal				
			BXRIA36036SSCME		980	2" black hard casters	standard metal				
			BXRIA24024SSSME		880	2" black soft casters	standard metal				
			BXRIA30030SSSME		940	2" black soft casters	standard metal				
			BXRIA36036SSSME		1,020	2" black soft casters	standard metal				
Novi 	gas assisted spring clip 22 x 22 26 x 26 32 x 32	24 x 24, 24 rd 30 x 30, 36 rd 36 x 36, 42 rd	1 1 1	BXNOV24024SGGME	1,090	adj glides	standard metal				
				BXNOV30030SGGME	1,120	adj glides	standard metal				
				BXNOV36036SGGME	1,170	adj glides	standard metal				
	22 x 22 26 x 26 32 x 32	24 x 24, 24 rd 30 x 30, 36 rd 36 x 36, 42 rd	1 1 1	BXNOV24024SGCME	1,180	2" black locking casters	standard metal				
				BXNOV30030SGCME	1,210	2" black locking casters	standard metal				
				BXNOV36036SGCME	1,250	2" black locking casters	standard metal				
				Moto 	ratchet X 22 26	24 x 24, 30 rd 30 x 30, 36 rd	1 1	BXMOT24024SRGME	960	adj glides	standard metal
								BXMOT30030SRGME	1,000	adj glides	standard metal
								BXMOT24024SRCME	1,050	2" black locking casters	standard metal
22 26	24 x 24, 30 rd 30 x 30, 36 rd	1 1	BXMOT30030SRCME		1,090	2" black locking casters	standard metal				
			BXMOT24024SRPME		1,090	2" premium locking casters	standard metal				
			BXMOT30030SRPME		1,130	2" premium locking casters	standard metal				
			pneumatic counter balance X 		crank X 22 26	24 x 24, 30 rd 30 x 30, 36 rd	1 1	BXMOT24024SCGME	1,100	adj glides	standard metal
								BXMOT30030SCGME	1,160	adj glides	standard metal
								BXMOT24024SCCME	1,190	2" black locking casters	standard metal
22 26	24 x 24, 30 rd 30 x 30, 36 rd	1 1		BXMOT30030SCCME	1,240	2" black locking casters	standard metal				
				BXMOT24024SCPME	1,230	2" premium locking casters	standard metal				
				BXMOT30030SCPME	1,290	2" premium locking casters	standard metal				
				22 x 22 26 x 26 32 x 32 36 x 36	24 x 24, 30 rd 30 x 30, 36 rd 36 x 36, 42 rd 42 x 42, 48 rd	1 1 1 1	BXMOT24024SPGME	1,310	adj glides	standard metal	
							BXMOT30030SPGME	1,350	adj glides	standard metal	
							BXMOT36036SPGME	1,390	adj glides	standard metal	
BXMOT42042SPGME	1,430	adj glides	standard metal								
BXMOT24024SPCME	1,400	2" black locking casters	standard metal								
BXMOT30030SPCME	1,440	2" black locking casters	standard metal								
BXMOT36036SPCME	1,470	2" black locking casters	standard metal								
BXMOT42042SPCME	1,520	2" black locking casters	standard metal								
BXMOT24024SPPME	1,440	2" premium locking casters	standard metal								
BXMOT30030SPPME	1,490	2" premium locking casters	standard metal								
BXMOT36036SPPME	1,520	2" premium locking casters	standard metal								
BXMOT42042SPPME	1,560	2" premium locking casters	standard metal								

**SS Spring clip height adjustment (Keller & Ria)**  
24.75" - 33.75" base height range with glides  
26.75" - 35.75" base height range with casters  
six heights in 1" increments

**SG Gas assisted spring clip height adjustment (Novi)**  
27.75" - 39.75" height range with glides or casters  
adjustable in 1" increments  
gas assisted spring allows adjustment of inner column  
inner column runs on roller bearings

**R Ratchet height adjustment (Moto)**  
26" - 35.5" base height range with glides  
28" - 37.5" base height range with casters  
13 positions in 0.78 inch increments  
change positions by manually lifting the table top  
resets to lowest position when lifted to upper stop



**C Crank adjustment (Moto)**  
base height range with glides 26" - 43.75"  
base height range with casters 28" - 45.75"  
-screw thread adjustment with infinite stop positions  
-adjust with manual crank handle which slides under table when not in use



**P Pneumatic counter balance (Moto)**  
base height range with glides 26" - 45.5"  
base height range with casters 28" - 47.5"  
-Must specify the weight of the top and all accessories that will be used on the bases so that the lift capacity can be set properly.

# bases

## four column X

### Keller, Novi

base	base dim.	max top support	base qty	base model no.	list	glides or casters	finish	
Keller 	27.75"H	38 x 38	48 x 48, 60 rd	1	BXKEL480484DGME	1,280	adj glides	standard metal
		46 x 46	54 x 54, 66 rd	1	BXKEL540544DGME	1,370	adj glides	standard metal
		58 x 58	60 x 60, 72 rd	1	BXKEL600604DGME	1,430	adj glides	standard metal
		38 x 38	48 x 48, 60 rd	1	BXKEL480484DCME	1,360	2" black hard casters	standard metal
		46 x 46	54 x 54, 66 rd	1	BXKEL540544DCME	1,450	2" black hard casters	standard metal
		58 x 58	60 x 60, 72 rd	1	BXKEL600604DCME	1,510	2" black hard casters	standard metal
		38 x 38	48 x 48, 60 rd	1	BXKEL480484DSME	1,400	2" black soft casters	standard metal
		46 x 46	54 x 54, 66 rd	1	BXKEL540544DSME	1,490	2" black soft casters	standard metal
		58 x 58	60 x 60, 72 rd	1	BXKEL600604DSME	1,550	2" black soft casters	standard metal
		38 x 38	48 x 48, 60 rd	1	BXKEL480484DGPO	1,800	adj glides	polished
		46 x 46	54 x 54, 66 rd	1	BXKEL540544DGPO	1,890	adj glides	polished
		58 x 58	60 x 60, 72 rd	1	BXKEL600604DGPO	1,950	adj glides	polished
	38 x 38	48 x 48, 60 rd	1	BXKEL480484DCPO	1,880	2" black hard casters	polished	
	46 x 46	54 x 54, 66 rd	1	BXKEL540544DCPO	1,970	2" black hard casters	polished	
	58 x 58	60 x 60, 72 rd	1	BXKEL600604DCPO	2,030	2" black hard casters	polished	
	38 x 38	48 x 48, 60 rd	1	BXKEL480484DSPO	1,920	2" black soft casters	polished	
	46 x 46	54 x 54, 66 rd	1	BXKEL540544DSPO	2,010	2" black soft casters	polished	
	58 x 58	60 x 60, 72 rd	1	BXKEL600604DSPO	2,070	2" black soft casters	polished	
custom taller height (specify height)	38 x 38	48 x 48, 60 rd	1	BXKEL480484HGME	1,530	adj glides	standard metal	
	46 x 46	54 x 54, 66 rd	1	BXKEL540544HGME	1,620	adj glides	standard metal	
	58 x 58	60 x 60, 72 rd	1	BXKEL600604HGME	1,680	adj glides	standard metal	
	38 x 38	48 x 48, 60 rd	1	BXKEL480484HCME	1,610	2" black hard casters	standard metal	
	46 x 46	54 x 54, 66 rd	1	BXKEL540544HCME	1,700	2" black hard casters	standard metal	
	58 x 58	60 x 60, 72 rd	1	BXKEL600604HCME	1,760	2" black hard casters	standard metal	
	38 x 38	48 x 48, 60 rd	1	BXKEL480484HSME	1,610	2" black soft casters	standard metal	
	46 x 46	54 x 54, 66 rd	1	BXKEL540544HSME	1,700	2" black soft casters	standard metal	
	58 x 58	60 x 60, 72 rd	1	BXKEL600604HSME	1,760	2" black soft casters	standard metal	
	38 x 38	48 x 48, 60 rd	1	BXKEL480484HGPO	2,050	adj glides	polished	
	46 x 46	54 x 54, 66 rd	1	BXKEL540544HGPO	2,140	adj glides	polished	
	58 x 58	60 x 60, 72 rd	1	BXKEL600604HGPO	2,200	adj glides	polished	
	38 x 38	48 x 48, 60 rd	1	BXKEL480484HCPO	2,130	2" black hard casters	polished	
	46 x 46	54 x 54, 66 rd	1	BXKEL540544HCPO	2,220	2" black hard casters	polished	
	58 x 58	60 x 60, 72 rd	1	BXKEL600604HCPO	2,280	2" black hard casters	polished	
	38 x 38	48 x 48, 60 rd	1	BXKEL480484HSPO	2,170	2" black soft casters	polished	
	46 x 46	54 x 54, 66 rd	1	BXKEL540544HSPO	2,260	2" black soft casters	polished	
	58 x 58	60 x 60, 72 rd	1	BXKEL600604HSPO	2,320	2" black soft casters	polished	
Novi 	27.75"H	36 x 36	54 x 54, 60 rd	1	BXNOV540544DGME	950	adj glides	standard metal
		36 x 36	54 x 54, 60 rd	1	BXNOV540544DCME	1,060	2" black locking casters	standard metal
custom taller height (specify height)	36 x 36	54 x 54, 60 rd	1	BXNOV540544HGME	1,400	adj glides	standard metal	
	36 x 36	54 x 54, 60 rd	1	BXNOV540544HCME	1,510	2" black locking casters	standard metal	

-  **C casters**  
2" black dual wheel locking hard casters (for carpet)
-  **S casters (Keller)**  
2" black dual wheel locking soft casters (for hard floors)



**Standard metal powder coat finishes (ME):**  
Black Wrinkle (BW), Chateau Brown Wrinkle (CB), Flat Black (FB), Furniture White (FW), Inner Tone (IT), Light Tone (LT), Medium Tone (MT), Metallic Silver (MS).



**Premium Polished Finishes:**  
PO Polished aluminum/steel (Ria + Keller)

# bases

## four column X

### Ria, Zoey

base	base dim.	max top support	base qty	base model no.	list	glides or casters	finish	
Ria 	27.75"H	38 x 38	48 x 48, 60 rd	1	BXRIA480484DGME	1,170	adj glides	standard metal
		46 x 46	54 x 54, 66 rd	1	BXRIA540544DGME	1,260	adj glides	standard metal
		58 x 58	60 x 60, 72 rd	1	BXRIA600604DGME	1,350	adj glides	standard metal
		38 x 38	48 x 48, 60 rd	1	BXRIA480484DCME	1,250	2" black hard casters	standard metal
		46 x 46	54 x 54, 66 rd	1	BXRIA540544DCME	1,340	2" black hard casters	standard metal
		58 x 58	60 x 60, 72 rd	1	BXRIA600604DCME	1,430	2" black hard casters	standard metal
		38 x 38	48 x 48, 60 rd	1	BXRIA480484DSME	1,290	2" black soft casters	standard metal
		46 x 46	54 x 54, 66 rd	1	BXRIA540544DSME	1,380	2" black soft casters	standard metal
		58 x 58	60 x 60, 72 rd	1	BXRIA600604DSME	1,470	2" black soft casters	standard metal
		38 x 38	48 x 48, 60 rd	1	BXRIA480484DGPO	1,670	adj glides	polished
		46 x 46	54 x 54, 66 rd	1	BXRIA540544DGPO	1,760	adj glides	polished
		58 x 58	60 x 60, 72 rd	1	BXRIA600604DGPO	1,850	adj glides	polished
	38 x 38	48 x 48, 60 rd	1	BXRIA480484DCPO	1,750	2" black hard casters	polished	
	46 x 46	54 x 54, 66 rd	1	BXRIA540544DCPO	1,840	2" black hard casters	polished	
	58 x 58	60 x 60, 72 rd	1	BXRIA600604DCPO	1,930	2" black hard casters	polished	
	38 x 38	48 x 48, 60 rd	1	BXRIA480484DSPO	1,790	2" black soft casters	polished	
	46 x 46	54 x 54, 66 rd	1	BXRIA540544DSPO	1,880	2" black soft casters	polished	
	58 x 58	60 x 60, 72 rd	1	BXRIA600604DSPO	1,970	2" black soft casters	polished	
custom taller height (specify height)	38 x 38	48 x 48, 60 rd	1	BXRIA480484HGME	1,390	adj glides	standard metal	
	46 x 46	54 x 54, 66 rd	1	BXRIA540544HGME	1,480	adj glides	standard metal	
	58 x 58	60 x 60, 72 rd	1	BXRIA600604HGME	1,570	adj glides	standard metal	
	38 x 38	48 x 48, 60 rd	1	BXRIA480484HCME	1,470	2" black hard casters	standard metal	
	46 x 46	54 x 54, 66 rd	1	BXRIA540544HCME	1,560	2" black hard casters	standard metal	
	58 x 58	60 x 60, 72 rd	1	BXRIA600604HCME	1,650	2" black hard casters	standard metal	
	38 x 38	48 x 48, 60 rd	1	BXRIA480484HSME	1,510	2" black soft casters	standard metal	
	46 x 46	54 x 54, 66 rd	1	BXRIA540544HSME	1,600	2" black soft casters	standard metal	
	58 x 58	60 x 60, 72 rd	1	BXRIA600604HSME	1,690	2" black soft casters	standard metal	
	38 x 38	48 x 48, 60 rd	1	BXRIA480484HGPO	1,950	adj glides	polished	
	46 x 46	54 x 54, 66 rd	1	BXRIA540544HGPO	2,040	adj glides	polished	
	58 x 58	60 x 60, 72 rd	1	BXRIA600604HGPO	2,140	adj glides	polished	
	38 x 38	48 x 48, 60 rd	1	BXRIA480484HCPO	2,030	2" black hard casters	polished	
	46 x 46	54 x 54, 66 rd	1	BXRIA540544HCPO	2,120	2" black hard casters	polished	
	58 x 58	60 x 60, 72 rd	1	BXRIA600604HCPO	2,220	2" black hard casters	polished	
	38 x 38	48 x 48, 60 rd	1	BXRIA480484HSPO	2,070	2" black soft casters	polished	
	46 x 46	54 x 54, 66 rd	1	BXRIA540544HSPO	2,160	2" black soft casters	polished	
	58 x 58	60 x 60, 72 rd	1	BXRIA600604HSPO	2,260	2" black soft casters	polished	
Zoey 	27.75"H	31 x 31	48 rd	1	BXZO248000RD4DGME	1,830	adj glides	standard metal
		35 x 35	54 rd	1	BXZO254000RD4DGME	1,850	adj glides	standard metal
		35 x 35	60 rd	1	BXZO260000RD4DGME	1,870	adj glides	standard metal
		31 x 31	42 x 42 sq	1	BXZO242042SQ4DGME	1,820	adj glides	standard metal
		35 x 35	48 x 48 sq	1	BXZO248048SQ4DGME	1,850	adj glides	standard metal
		40 x 40	54 x 54 sq	1	BXZO254054SQ4DGME	1,910	adj glides	standard metal
		44 x 44	60 x 60 sq	1	BXZO260060SQ4DGME	1,960	adj glides	standard metal

-  **C casters (Ria & Rosanno)**  
2" black dual wheel locking hard casters (for carpet)
-  **S casters (Ria)**  
2" black dual wheel locking soft casters (for hard floors)

**Standard metal powder coat finishes (ME):**  
Black Wrinkle (BW), Chateau Brown Wrinkle (CB), Flat Black (FB), Furniture White (FW), Inner Tone (IT), Light Tone (LT), Medium Tone (MT), Metallic Silver (MS).

**Premium Polished Finishes:**  
PO Polished aluminum/steel (Ria + Keller)



# bases

tripod Y fixed, flip and adjustable height

Keller

base	base dim.	max top support	base qty	base model no.	list	glides or casters	finish
Keller fixed tripod Y 27.75"H	20 x 20	24 x 24, 24 rd	1	BYKEL24024SDGME	500	adj glides	standard metal
	26 x 26	30 x 30, 30 rd	1	BYKEL30030SDGME	550	adj glides	standard metal
	33 x 33	36 x 36, 36 rd	1	BYKEL36036SDGME	600	adj glides	standard metal
	20 x 20	24 x 24, 24 rd	1	BYKEL24024SDCME	560	2" black hard casters	standard metal
	26 x 26	30 x 30, 30 rd	1	BYKEL30030SDCME	610	2" black hard casters	standard metal
	33 x 33	36 x 36, 36 rd	1	BYKEL36036SDCME	660	2" black hard casters	standard metal
	20 x 20	24 x 24, 24 rd	1	BYKEL24024SDSME	590	2" black soft casters	standard metal
	26 x 26	30 x 30, 30 rd	1	BYKEL30030SDSME	640	2" black soft casters	standard metal
	33 x 33	36 x 36, 36 rd	1	BYKEL36036SDSME	690	2" black soft casters	standard metal
	20 x 20	24 x 24, 24 rd	1	BYKEL24024SDGPO	640	adj glides	polished
	26 x 26	30 x 30, 30 rd	1	BYKEL30030SDGPO	690	adj glides	polished
	33 x 33	36 x 36, 36 rd	1	BYKEL36036SDGPO	740	adj glides	polished
custom lower height (specify height)	20 x 20	24 x 24, 24 rd	1	BYKEL24024SLGME	590	adj glides	standard metal
	26 x 26	30 x 30, 30 rd	1	BYKEL30030SLGME	640	adj glides	standard metal
	33 x 33	36 x 36, 36 rd	1	BYKEL36036SLGME	690	adj glides	standard metal
	20 x 20	24 x 24, 24 rd	1	BYKEL24024SLCME	650	2" black hard casters	standard metal
	26 x 26	30 x 30, 30 rd	1	BYKEL30030SLCME	700	2" black hard casters	standard metal
	33 x 33	36 x 36, 36 rd	1	BYKEL36036SLCME	750	2" black hard casters	standard metal
	20 x 20	24 x 24, 24 rd	1	BYKEL24024SLSME	680	2" black soft casters	standard metal
	26 x 26	30 x 30, 30 rd	1	BYKEL30030SLSME	730	2" black soft casters	standard metal
	33 x 33	36 x 36, 36 rd	1	BYKEL36036SLSME	780	2" black soft casters	standard metal
	20 x 20	24 x 24, 24 rd	1	BYKEL24024SLGPO	730	adj glides	polished
	26 x 26	30 x 30, 30 rd	1	BYKEL30030SLGPO	780	adj glides	polished
	33 x 33	36 x 36, 36 rd	1	BYKEL36036SLGPO	830	adj glides	polished
flip Y	20 x 20	24 x 24, 24 rd	1	BYKEL24024SLCPO	790	2" black hard casters	polished
	26 x 26	30 x 30, 30 rd	1	BYKEL30030SLCPO	840	2" black hard casters	polished
	33 x 33	36 x 36, 36 rd	1	BYKEL36036SLCPO	890	2" black hard casters	polished
	20 x 20	24 x 24, 24 rd	1	BYKEL24024SLSPO	820	2" black soft casters	polished
	26 x 26	30 x 30, 30 rd	1	BYKEL30030SLSPO	870	2" black soft casters	polished
	33 x 33	36 x 36, 36 rd	1	BYKEL36036SLSPO	920	2" black soft casters	polished
	20 x 20	24 x 24, 24 rd	1	BYKEL24024FDGME	760	adj glides	standard metal
	26 x 26	30 x 30, 30 rd	1	BYKEL30030FDGME	810	adj glides	standard metal
	33 x 33	36 x 36, 36 rd	1	BYKEL36036FDGME	860	adj glides	standard metal
	20 x 20	24 x 24, 24 rd	1	BYKEL24024FDCME	820	2" black hard casters	standard metal
	26 x 26	30 x 30, 30 rd	1	BYKEL30030FDCME	870	2" black hard casters	standard metal
	33 x 33	36 x 36, 36 rd	1	BYKEL36036FDCME	920	2" black hard casters	standard metal
Y spring clip	20 x 20	24 x 24, 24 rd	1	BYKEL24024FDSME	850	2" black soft casters	standard metal
	26 x 26	30 x 30, 30 rd	1	BYKEL30030FDSME	900	2" black soft casters	standard metal
	33 x 33	36 x 36, 36 rd	1	BYKEL36036FDSME	950	2" black soft casters	standard metal
	20 x 20	24 x 24, 24 rd	1	BYKEL24024FDGPO	910	adj glides	polished
	26 x 26	30 x 30, 30 rd	1	BYKEL30030FDGPO	960	adj glides	polished
	33 x 33	36 x 36, 36 rd	1	BYKEL36036FDGPO	1,010	adj glides	polished
	20 x 20	24 x 24, 24 rd	1	BYKEL24024FDCPO	970	2" black hard casters	polished
	26 x 26	30 x 30, 30 rd	1	BYKEL30030FDCPO	1,020	2" black hard casters	polished
	33 x 33	36 x 36, 36 rd	1	BYKEL36036FDCPO	1,070	2" black hard casters	polished
	20 x 20	24 x 24, 24 rd	1	BYKEL24024FDSPO	1,000	2" black soft casters	polished
	26 x 26	30 x 30, 30 rd	1	BYKEL30030FDSPO	1,050	2" black soft casters	polished
	33 x 33	36 x 36, 36 rd	1	BYKEL36036FDSPO	1,100	2" black soft casters	polished
Y spring clip	20 x 20	24 x 24, 24 rd	1	BYKEL24024SSGME	740	adj glides	standard metal
	26 x 26	30 x 30, 30 rd	1	BYKEL30030SSGME	790	adj glides	standard metal
	33 x 33	36 x 36, 36 rd	1	BYKEL36036SSGME	840	adj glides	standard metal
	20 x 20	24 x 24, 24 rd	1	BYKEL24024SSCME	800	2" black hard casters	standard metal
	26 x 26	30 x 30, 30 rd	1	BYKEL30030SSCME	850	2" black hard casters	standard metal
	33 x 33	36 x 36, 36 rd	1	BYKEL36036SSCME	900	2" black hard casters	standard metal
	20 x 20	24 x 24, 24 rd	1	BYKEL24024SSSME	830	2" black soft casters	standard metal
	26 x 26	30 x 30, 30 rd	1	BYKEL30030SSSME	880	2" black soft casters	standard metal
	33 x 33	36 x 36, 36 rd	1	BYKEL36036SSSME	930	2" black soft casters	standard metal

**C casters (Keller & Ria)**  
2" black dual wheel locking hard casters (for carpet)

**S casters (Keller & Ria)**  
2" black dual wheel locking soft casters (for hard floors)

**SS Spring clip height adjustment (Keller & Ria)**  
24.75" - 33.75" base height range with glides  
six heights in 1" increments

**Standard metal powder coat finishes (ME)**  
Black Wrinkle, Chateau Brown Wrinkle, Flat Black, Furniture White, Inner Tone, Light Tone, Medium Tone and Metallic Silver

**Premium Polished Finish (PO)**  
Polished Aluminum/Steel

# bases

tripod Y fixed, flip and adjustable height

Ria

base	base dim.	max top support	base qty	base model no.	list	glides or casters	finish
Ria fixed tripod Y 27.75"H	20 x 20	24 x 24, 24 rd	1	BYRIA24024SDGME	470	adj glides	standard metal
	26 x 26	30 x 30, 30 rd	1	BYRIA30030SDGME	520	adj glides	standard metal
	33 x 33	36 x 36, 36 rd	1	BYRIA36036SDGME	570	adj glides	standard metal
	20 x 20	24 x 24, 24 rd	1	BYRIA24024SDCME	530	2" black hard casters	standard metal
	26 x 26	30 x 30, 30 rd	1	BYRIA30030SDCME	580	2" black hard casters	standard metal
	33 x 33	36 x 36, 36 rd	1	BYRIA36036SDCME	630	2" black hard casters	standard metal
	20 x 20	24 x 24, 24 rd	1	BYRIA24024SDSME	560	2" black soft casters	standard metal
	26 x 26	30 x 30, 30 rd	1	BYRIA30030SDSME	610	2" black soft casters	standard metal
	33 x 33	36 x 36, 36 rd	1	BYRIA36036SDSME	660	2" black soft casters	standard metal
	20 x 20	24 x 24, 24 rd	1	BYRIA24024SDGPO	590	adj glides	polished
	26 x 26	30 x 30, 30 rd	1	BYRIA30030SDGPO	630	adj glides	polished
	33 x 33	36 x 36, 36 rd	1	BYRIA36036SDGPO	670	adj glides	polished
custom lower height (specify height)	20 x 20	24 x 24, 24 rd	1	BYRIA24024SLGME	560	adj glides	standard metal
	26 x 26	30 x 30, 30 rd	1	BYRIA30030SLGME	610	adj glides	standard metal
	33 x 33	36 x 36, 36 rd	1	BYRIA36036SLGME	660	adj glides	standard metal
	20 x 20	24 x 24, 24 rd	1	BYRIA24024SLCME	620	2" black hard casters	standard metal
	26 x 26	30 x 30, 30 rd	1	BYRIA30030SLCME	670	2" black hard casters	standard metal
	33 x 33	36 x 36, 36 rd	1	BYRIA36036SLCME	720	2" black hard casters	standard metal
	20 x 20	24 x 24, 24 rd	1	BYRIA24024SLSME	650	2" black soft casters	standard metal
	26 x 26	30 x 30, 30 rd	1	BYRIA30030SLSME	700	2" black soft casters	standard metal
	33 x 33	36 x 36, 36 rd	1	BYRIA36036SLSME	750	2" black soft casters	standard metal
	20 x 20	24 x 24, 24 rd	1	BYRIA24024SLGPO	680	adj glides	polished
	26 x 26	30 x 30, 30 rd	1	BYRIA30030SLGPO	720	adj glides	polished
	33 x 33	36 x 36, 36 rd	1	BYRIA36036SLGPO	760	adj glides	polished
flip Y	20 x 20	24 x 24, 24 rd	1	BYRIA24024SLCPO	740	2" black hard casters	polished
	26 x 26	30 x 30, 30 rd	1	BYRIA30030SLCPO	780	2" black hard casters	polished
	33 x 33	36 x 36, 36 rd	1	BYRIA36036SLCPO	820	2" black hard casters	polished
	20 x 20	24 x 24, 24 rd	1	BYRIA24024SLSPO	770	2" black soft casters	polished
	26 x 26	30 x 30, 30 rd	1	BYRIA30030SLSPO	810	2" black soft casters	polished
	33 x 33	36 x 36, 36 rd	1	BYRIA36036SLSPO	850	2" black soft casters	polished
	20 x 20	24 x 24, 24 rd	1	BYRIA24024FDGME	740	adj glides	standard metal
	26 x 26	30 x 30, 30 rd	1	BYRIA30030FDGME	780	adj glides	standard metal
	33 x 33	36 x 36, 36 rd	1	BYRIA36036FDGME	840	adj glides	standard metal
	20 x 20	24 x 24, 24 rd	1	BYRIA24024FDCME	800	2" black hard casters	standard metal
	26 x 26	30 x 30, 30 rd	1	BYRIA30030FDCME	840	2" black hard casters	standard metal
	33 x 33	36 x 36, 36 rd	1	BYRIA36036FDCME	900	2" black hard casters	standard metal
Y spring clip	20 x 20	24 x 24, 24 rd	1	BYRIA24024FDSME	830	2" black soft casters	standard metal
	26 x 26	30 x 30, 30 rd	1	BYRIA30030FDSME	870	2" black soft casters	standard metal
	33 x 33	36 x 36, 36 rd	1	BYRIA36036FDSME	930	2" black soft casters	standard metal
	20 x 20	24 x 24, 24 rd	1	BYRIA24024FDGPO	840	adj glides	polished
	26 x 26	30 x 30, 30 rd	1	BYRIA30030FDGPO	890	adj glides	polished
	33 x 33	36 x 36, 36 rd	1	BYRIA36036FDGPO	950	adj glides	polished
	20 x 20	24 x 24, 24 rd	1	BYRIA24024FDCPO	900	2" black hard casters	polished
	26 x 26	30 x 30, 30 rd	1	BYRIA30030FDCPO	950	2" black hard casters	polished
	33 x 33	36 x 36, 36 rd	1	BYRIA36036FDCPO	1,010	2" black hard casters	polished
	20 x 20	24 x 24, 24 rd	1	BYRIA24024FDSPO	930	2" black soft casters	polished
	26 x 26	30 x 30, 30 rd	1	BYRIA30030FDSPO	980	2" black soft casters	polished
	33 x 33	36 x 36, 36 rd	1	BYRIA36036FDSPO	1,040	2" black soft casters	polished
Y spring clip	20 x 20	24 x 24, 24 rd	1	BYRIA24024SSGME	740	adj glides	standard metal
	26 x 26	30 x 30, 30 rd	1	BYRIA30030SSGME	780	adj glides	standard metal
	33 x 33	36 x 36, 36 rd	1	BYRIA36036SSGME	840	adj glides	standard metal
	20 x 20	24 x 24, 24 rd	1	BYRIA24024SSCME	800	2" black hard casters	standard metal
	26 x 26	30 x 30, 30 rd	1	BYRIA30030SSCME	840	2" black hard casters	standard metal
	33 x 33	36 x 36, 36 rd	1	BYRIA36036SSCME	900	2" black hard casters	standard metal
	20 x 20	24 x 24, 24 rd	1	BYRIA24024SSSME	830	2" black soft casters	standard metal
	26 x 26	30 x 30, 30 rd	1	BYRIA30030SSSME	870	2" black soft casters	standard metal
	33 x 33	36 x 36, 36 rd	1	BYRIA36036SSSME	930	2" black soft casters	standard metal

Power module cone shaped top plate - #OBXWMPCC \$350 list (only available for fixed Y bases)

metal cone-shaped top plate conceals and protects center mounted power module in surface.  
Concealed wires exit down inside the base column and out at the bottom of the base column.  
Note that the cone cannot be made with the polished finish, black or white paint is available for the cone with a polished base.  
The Circo power unit can be used with this cone wire manager.









Wire management hole set (2) in column - #OBTWMH2G \$50 list (only available for fixed Y bases)  
each hole is 1.25" x 2.25". Removeable grommets narrows hole to 1.25" diameter  
Note that the wire management grommet cannot be made with the polished finish



# bases

## personal workstation

### Una fixed height wheel barrow, round column

base	base dim.	max top support	base qty	base model no.	list	glides / casters	finish	
<b>Una fixed height wheel barrow round column (27.75"H)</b>								
	H flip	18 x 30	24 x 36	1	BHUNAR2436FDHME	1,140	2 adj glides / 2 casters	standard metal
	H tilt	18 x 30	24 x 36	1	BHUNAR2436TDHME	1,180	2 adj glides / 2 casters	standard metal
	H fixed	18 x 30	24 x 36	1	BHUNAR2436SDHME	880	2 adj glides / 2 casters	standard metal
<b>Una fixed height wheel barrow round column (custom taller height - specify height)</b>								
	H flip	18 x 30	24 x 36	1	BHUNAR2436FHHME	1,240	2 adj glides / 2 casters	standard metal
	H tilt	18 x 30	24 x 36	1	BHUNAR2436THHME	1,280	2 adj glides / 2 casters	standard metal
	H fixed	18 x 30	24 x 36	1	BHUNAR2436SHHME	980	2 adj glides / 2 casters	standard metal
<b>Una fixed height wheel barrow round column (custom lower height - specify height*)</b>								
<small>*20" minimum height with glides or 22" minimum height with casters</small>								
	H flip	18 x 30	24 x 36	1	BHUNAR2436FLHME	1,240	2 adj glides / 2 casters	standard metal
	H tilt	18 x 30	24 x 36	1	BHUNAR2436TLHME	1,280	2 adj glides / 2 casters	standard metal
	H fixed	18 x 30	24 x 36	1	BHUNAR2436SLHME	980	2 adj glides / 2 casters	standard metal

\* top not included

**Standard metal powder coat finishes (ME):**  
Black Wrinkle, Chateau Brown Wrinkle, Flat Black, Furniture White, Inner Tone, Light Tone, Medium Tone, and Metallic Silver









The Wheel Barrow base features 2 glides and 2 casters.



# bases

## personal workstation

### Una fixed height wheel barrow, square column

base	base dim.	max top support	base qty	base model no.	list	glides or casters	finish	
<b>Una fixed height wheel barrow square column (27.75"H)</b>								
	H flip	18 x 30	24 x 36	1	BHUNAS2436FDHME	1,140	2 adj glides / 2 casters	standard metal
	H tilt	18 x 30	24 x 36	1	BHUNAS2436TDHME	1,180	2 adj glides / 2 casters	standard metal
	H fixed	18 x 30	24 x 36	1	BHUNAS2436SDHME	880	2 adj glides / 2 casters	standard metal
<b>Una fixed height wheel barrow square column (custom taller height - specify height)</b>								
	H flip	18 x 30	24 x 36	1	BHUNAS2436FHHME	1,240	2 adj glides / 2 casters	standard metal
	H tilt	18 x 30	24 x 36	1	BHUNAS2436THHME	1,280	2 adj glides / 2 casters	standard metal
	H fixed	18 x 30	24 x 36	1	BHUNAS2436SHHME	980	2 adj glides / 2 casters	standard metal
<b>Una fixed height wheel barrow square column (custom lower height - specify height*)</b>								
<small>*20" minimum height with glides or 22" minimum height with casters</small>								
	H flip	18 x 30	24 x 36	1	BHUNAS2436FLHME	1,240	2 adj glides / 2 casters	standard metal
	H tilt	18 x 30	24 x 36	1	BHUNAS2436TLHME	1,280	2 adj glides / 2 casters	standard metal
	H fixed	18 x 30	24 x 36	1	BHUNAS2436SLHME	980	2 adj glides / 2 casters	standard metal

\* top not included

**Standard metal powder coat finishes (ME):**  
Black Wrinkle, Chateau Brown Wrinkle, Flat Black, Furniture White, Inner Tone, Light Tone, Medium Tone, and Metallic Silver







The Wheel Barrow base features 2 glides and 2 casters..



# bases

## personal workstation

### Una pneumatic adjustable height









base	base dim.	max top support	base qty	base model no.	list	glides or casters	finish	
<b>Una pneumatic height adj round column</b>								
	V flip	18 x 30	24 x 30	1	BVUNAR2430FPGME	1,680	adj glides	standard metal
		18 x 30	24 x 30	1	BVUNAR2430FPCME	1,770	2" black hard casters	standard metal
		18 x 30	24 x 30	1	BVUNAR2430FPSME	1,820	2" black soft casters	standard metal
		18 x 30	24 x 30	1	BVUNAR2430FPPME	1,820	2" premium hard casters	standard metal
Una V flip adj height range with glides is 29.07-46.7" without the top Una V flip adj height range with 2" locking casters is 31.07 - 48.7" without the top								
<b>Optional Drop Down Kit</b> (only for use with the 2" locking caster option) lowers the height range to 30.02" - 47.65" without the top <b>model number OBUNADROP \$60 list</b>								
	V tilt	18 x 30	24 x 30	1	BVUNAR2430TPGME	1,730	adj glides	standard metal
		18 x 30	24 x 30	1	BVUNAR2430TPCME	1,820	2" black hard casters	standard metal
		18 x 30	24 x 30	1	BVUNAR2430TPSME	1,860	2" black soft casters	standard metal
		18 x 30	24 x 30	1	BVUNAR2430TPPME	1,860	2" premium hard casters	standard metal
Una V tilt adj height range with glides is 29.07-46.7" without the top Una V tilt adj height range with 2" locking casters is 31.07 - 48.7" without the top								
<b>Optional Drop Down Kit</b> (only for use with the 2" locking caster option) lowers the height range to 30.02" - 47.65" without the top <b>model number OBUNADROP \$60 list</b>								
	V fixed	18 x 30	24 x 30	1	BVUNAR2430SPGME	1,530	adj glides	standard metal
		18 x 30	24 x 30	1	BVUNAR2430SPCME	1,620	2" black hard casters	standard metal
		18 x 30	24 x 30	1	BVUNAR2430SPSME	1,660	2" black soft casters	standard metal
		18 x 30	24 x 30	1	BVUNAR2430SPPME	1,660	2" premium hard casters	standard metal
Una V adj height range with glides is 26.01-43.73" without the top Una V adj height range with 2" locking casters is 28.5 - 46.13" without the top								
<b>Optional Drop Down Kit</b> (only for use with the 2" locking caster option) lowers the height range to 27.14" - 44.17" without the top <b>model number OBUNADROP \$60 list</b>								
	H flip	18 x 30	24 x 36	1	BHUNAR2436FPGME	1,680	adj glides	standard metal
		18 x 30	24 x 36	1	BHUNAR2436FPCME	1,770	2" black hard casters	standard metal
		18 x 30	24 x 36	1	BHUNAR2436FPSME	1,820	2" black soft casters	standard metal
		18 x 30	24 x 36	1	BHUNAR2436FPPME	1,820	2" premium hard casters	standard metal
Una H flip adj height range with glides is 28.89-46.52" without the top Una H flip adj height range with 2" locking casters is 31.29 - 48.92" without the top								
<b>Optional Drop Down Kit</b> (only for use with the 2" locking caster option) lowers the height range to 30.02" - 47.65" without the top <b>model number OBUNADROP \$60 list</b>								
	H tilt	18 x 30	24 x 36	1	BHUNAR2436TPGME	1,730	adj glides	standard metal
		18 x 30	24 x 36	1	BHUNAR2436TPCME	1,820	2" black hard casters	standard metal
		18 x 30	24 x 36	1	BHUNAR2436TPSME	1,860	2" black soft casters	standard metal
		18 x 30	24 x 36	1	BHUNAR2436TPPME	1,860	2" premium hard casters	standard metal
Una H tilt adj height range with glides is 31.29-46.52" without the top Una H tilt adj height range with 2" locking casters is 31.29 - 48.92" without the top								
<b>Optional Drop Down Kit</b> (only for use with the 2" locking caster option) lowers the height range to 30.02" - 47.65" without the top <b>model number OBUNADROP \$60 list</b>								
	H fixed	18 x 30	24 x 36	1	BHUNAR2436SPGME	1,530	adj glides	standard metal
		18 x 30	24 x 36	1	BHUNAR2436SPCME	1,620	2" black hard casters	standard metal
		18 x 30	24 x 36	1	BHUNAR2436SPSME	1,660	2" black soft casters	standard metal
		18 x 30	24 x 36	1	BHUNAR2436SPPME	1,660	2" premium hard casters	standard metal
Una H adj height range with glides is 26.1-43.73" without the top Una H adj height range with 2" locking casters is 28.5 - 46.13" without the top								
<b>Optional Drop Down Kit</b> (only for use with the 2" locking caster option) lowers the height range to 27.14" - 44.77" without the top <b>model number OBUNADROP \$60 list</b>								

\*top not included

# bases



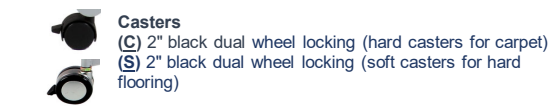





## personal workstation

### Una pneumatic adjustable height

base	base dim.	max top support	base qty	base model no.	list	glides or casters	finish	
<b>Una pneumatic height adj square column</b>								
	V fixed	18 x 30	24 x 30	1	BVUNAS2430SPGME	1,610	adj glides	standard metal
		18 x 30	24 x 30	1	BVUNAS2430SPCME	1,690	2" black hard casters	standard metal
		18 x 30	24 x 30	1	BVUNAS2430SPSME	1,740	2" black soft casters	standard metal
		18 x 30	24 x 30	1	BVUNAS2430SPPME	1,740	2" premium hard casters	standard metal
Una V adj height range with glides is 26-43.63" without the top Una V adj height range with 2" locking casters is 28.4 - 46.03" without the top								
<b>Optional Drop Down Kit</b> (only for use with the 2" locking caster option) lowers the height range to 27.13" - 44.76" without the top <b>model number OBUNADROP \$60 list</b>								
	H fixed	18 x 30	24 x 36	1	BHUNAS2436SPGME	1,610	adj glides	standard metal
		18 x 30	24 x 36	1	BHUNAS2436SPCME	1,690	2" black hard casters	standard metal
		18 x 30	24 x 36	1	BHUNAS2436SPSME	1,740	2" black soft casters	standard metal
		18 x 30	24 x 36	1	BHUNAS2436SPPME	1,740	2" premium hard casters	standard metal
Una H adj height range with glides is 26-43.63" without the top Una H adj height range with 2" locking casters is 28.4 - 46.03" without the top								
<b>Optional Drop Down Kit</b> (only for use with the 2" locking caster option) lowers the height range to 27.14" - 44.77" without the top <b>model number OBUNADROP \$60 list</b>								
<b>Una wheel barrow pneumatic height adj round column</b>								
	H flip	18 x 30	24 x 36	1	BHUNAR2436FPHME	1,790	2 adj glides / 2 casters	standard metal
		height range: 29.51" - 47.14" without the top						
	H tilt	18 x 30	24 x 36	1	BHUNAR2436TPHME	1,830	2 adj glides / 2 casters	standard metal
		height range: 29.51" - 47.14" without the top						
	H fixed	18 x 30	24 x 36	1	BHUNAR2436SPHME	1,640	2 adj glides / 2 casters	standard metal
		height range: 26.43" - 44.27" without the top						
<b>Una wheel barrow pneumatic height adj square column</b>								
	H fixed	18 x 30	24 x 36	1	BHUNAS2436SPHME	1,690	2 adj glides / 2 casters	standard metal
		height range: 26.63" - 44.26" without the top						
 <b>Casters</b> (C) 2" black dual wheel locking (hard casters for carpet) (S) 2" black dual wheel locking (soft casters for hard flooring)								
 <b>The Wheel Barrow base features 2 casters and 2</b>								
<b>Standard metal powder coat finishes for Una adjustable height bases (ME):</b> Flat Black (FB), Furniture White (FW), Metallic Silver (MS).								
Note that at least 24 x 30 top size is recommended for the <u>Una series bases</u> because the weight of the top is 22 lbs. This base has a lift range from 22 lbs to 44 lbs (including the top). If the accessories or items that will be placed on the base weigh over 22 lbs then please email <a href="mailto:service@symphontables.com">service@symphontables.com</a> for assistance.								
Additionally, if a smaller work surface than 24 x 30 is required then please email <a href="mailto:service@symphontable.com">service@symphontable.com</a> for assistance to review options on how to add weight to a smaller top to meet the 22 lb minimum requirement.								
The weight of the top and all accessories that will be used on the base shall be advised on the purchase order. If the weight is set wrong then it will cause the table to lift up too fast or not work at all. Contact <a href="mailto:service@symphontables.com">service@symphontables.com</a> for assistance.								

# bases

personal, fixed height  
Dino, Nora, Papa

base	base dim.	column	max top support	base model no.	list	finish	
<b>Dino fixed height</b>							
	rectangle	1.25" offset	12 x 18	BDDIN12018SDGME	430	standard metal	
			12 x 9 x 25.25H	18 x 12	BDDIN18012SDGME	430	standard metal
	round	1.25" offset	12 dia. x 25.25H	BDDIN18000SDGME	430	standard metal	
*Dino bases feature 1" x 3/16" soft plastic foot pads/felt pads, no adjustment							
<b>Nora fixed height</b>							
	rounded rectangle	1.5" offset	14 x 20	BDNOR142024OGME	930	standard metal	
				14 x 20	BDNOR142024OGPC	1,320	polished
	round	1.5" offset	20 rd	BDNOR20RD24OGME	930	standard metal	
				20 rd	BDNOR20RD24OGPC	1,250	polished
		1.5" centered	20 rd	BDNOR20RD24CGME	930	standard metal	
				20 rd	BDNOR20RD24CGPC	1,250	polished
	rounded square	1.5" centered	24 sq	BDNOR24RS24CGME	1,000	standard metal	
				24 sq	BDNOR24RS24CGPC	1,430	polished
bases feature a plastic glide for carpet and hard floor surfaces, no adjustment							
<b>Papa fixed height</b>							
	U	2" offset	14 x 20	BDPAPU1420OGME	930	standard metal	
	C	2" offset	18 rd	BDPAPC18RDOGME	930	standard metal	
	H	2" offset	20 sq	BDPAPH20SQOGME	930	standard metal	
	round	2" offset	20 rd	BDPAP20RD24OGME	930	standard metal	
				20 rd	BDPAP20RD24OGPC	1,250	polished
		2" centered	20 rd	BDPAP20RD24CGME	930	standard metal	
				20 rd	BDPAP20RD24CGPC	1,250	polished
*Papa bases feature a plastic glide for carpet and hard floor surfaces, no adjustment							

**(ME) Standard metal powder coat finishes (Nora)**  
Black Wrinkle (BW), Chateau Brown Wrinkle (CB), Flat Black (FB), Furniture White (FW), Inner Tone (IT), Light Tone (LT), Medium Tone (MT), Metallic Silver (MS).  
**(PC) Polished chrome finish (Nora)**











**(ME) Standard metal powder coat finishes (Dino + Polo)**  
Flat Black, Furniture White, Inner Tone, Light Tone, Medium Tone, and Metallic Silver

\*\* Note that the inner column of the Polo height adjustable base is only available in Flat Black, White or Metallic Silver. Note that Polo White is a shade off and a little creamier than Furniture White.

 **Optional Cup Holder - \$100 list**  
model number **ASCUPHLDR**

# bases

personal, adjustable height  
Nora, Papa, Polo

base	base dim.	column	max top support	base model no.	list	finish	
<b>Nora spring clip adj ht</b>							
	rounded rectangle	1.5" offset	14 x 20	BDNOR142024SOGME	1,220	standard metal	
				14 x 20	BDNOR142024SOGPC	1,610	polished
	round	1.5" offset	20 rd	BDNOR20RD24SOGME	1,220	standard metal	
				20 rd	BDNOR20RD24SOGPC	1,530	polished
		1.5" centered	20 rd	BDNOR20RD24SCGME	1,220	standard metal	
				20 rd	BDNOR20RD24SCGPC	1,530	polished
	rounded square	1.5" centered	24 sq	BDNOR24RS24SCGME	1,280	standard metal	
				24 sq	BDNOR24RS24SCGPC	1,710	polished
*Nora bases feature a plastic glide for carpet and hard floor surfaces, no adjustment							
<b>Papa spring clip adj ht</b>							
	U	2" offset	14 x 20	BDPAPU1420SOGME	1,020	standard metal	
	C	2" offset	18 rd	BDPAPC18RDSOGME	1,020	standard metal	
	H	2" offset	20 sq	BDPAPH20SQSOGME	1,020	standard metal	
	round	2" offset	20 rd	BDPAP20RD24SOGME	1,020	standard metal	
				20 rd	BDPAP20RD24SOGPC	1,330	polished
		2" centered	20 rd	BDPAP20RD24SCGME	1,020	standard metal	
				20 rd	BDPAP20RD24SCGPC	1,330	polished
*Papa bases feature a plastic glide for carpet and hard floor surfaces, no adjustment							
<b>Polo pneumatic adj ht</b>							
	rectangle	1.25" offset	12 x 18	BDPOL12018SPGME	780	standard metal	
	round	1.25" offset	18 x 12	BDPOL18012SPGME	780	standard metal	
	round	1.25" offset	18 rd	BDPOL18000SPGME	780	standard metal	
*Polo bases feature a 20.25" - 30" pneumatic adjustable height range 1" x 3/16" soft plastic foot pads/felt pads, no adjustment							

**(ME) Standard metal powder coat finishes (Nora)**  
Black Wrinkle (BW), Chateau Brown Wrinkle (CB), Flat Black (FB), Furniture White (FW), Inner Tone (IT), Light Tone (LT), Medium Tone (MT), Metallic Silver (MS).  
**(PC) Polished chrome finish (Nora)**

**(ME) Standard metal powder coat finishes (Dino + Polo)**  
Flat Black, Furniture White, Inner Tone, Light Tone, Medium Tone, and Metallic Silver

\*\* Note that the inner column of the Polo height adjustable base is only available in Flat Black, White or Metallic Silver. Note that Polo White is a shade



 **Optional Cup Holder - \$100 list**  
model number **ASCUPHLDR**

**Nora & Papa**  
**(SO)** spring clip height adjustable offset column  
**(SC)** spring clip height adjustable centered column  
height range 17" - 24"

# bases

## fixed height disc

### Bennett, Marius, Molly

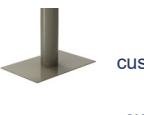
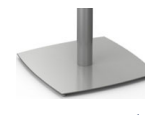

base	base dim.	column	max top support	base model no.	list	glides	finish		
	27.75"H	16 x 16	3" sq	30 x 30, 36 rd	BDBEN30030SDGME	780	adj glides	standard metal	
		20 x 20	3" sq	36 x 36, 42 rd	BDBEN36036SDGME	860	adj glides	standard metal	
		26 x 26	3" sq	42 x 42, 48 rd	BDBEN42042SDGME	1,030	adj glides	standard metal	
	40.75"H	16 x 16	3" sq	30 x 30, 36 rd	BDBEN30030SBGME	870	adj glides	standard metal	
		20 x 20	3" sq	36 x 36, 42 rd	BDBEN36036SBGME	950	adj glides	standard metal	
		26 x 26	3" sq	42 x 42, 48 rd	BDBEN42042SBGME	1,120	adj glides	standard metal	
		custom higher height (specify height)	16 x 16	3" sq	30 x 30, 36 rd	BDBEN30030SHGME	870	adj glides	standard metal
		20 x 20	3" sq	36 x 36, 42 rd	BDBEN36036SHGME	950	adj glides	standard metal	
		26 x 26	3" sq	42 x 42, 48 rd	BDBEN42042SHGME	1,120	adj glides	standard metal	
	27.75"H	16 x 16	3" rd	30 x 30, 36 rd	BDMAR30030SDGME	780	adj glides	standard metal	
		20 x 20	4" rd	36 x 36, 42 rd	BDMAR36036SDGME	860	adj glides	standard metal	
		26 x 26	4" rd	42 x 42, 48 rd	BDMAR42042SDGME	1,030	adj glides	standard metal	
		24 x 24	6" rd	48 x 48, 48 rd	BDMAR48048SDGME	1,390	adj glides	standard metal	
	40.75"H	16 x 16	3" rd	30 x 30, 36 rd	BDMAR30030SBGME	910	adj glides	standard metal	
		20 x 20	4" rd	36 x 36, 42 rd	BDMAR36036SBGME	990	adj glides	standard metal	
		26 x 26	4" rd	42 x 42, 48 rd	BDMAR42042SBGME	1,170	adj glides	standard metal	
		24 x 24	6" rd	48 x 48, 48 rd	BDMAR48048SBGME	1,750	adj glides	standard metal	
		custom higher height (specify height)	16 x 16	3" rd	30 x 30, 36 rd	BDMAR30030SHGME	910	adj glides	standard metal
20 x 20	4" rd	36 x 36, 42 rd	BDMAR36036SHGME	990	adj glides	standard metal			
26 x 26	4" rd	42 x 42, 48 rd	BDMAR42042SHGME	1,170	adj glides	standard metal			
24 x 24	6" rd	48 x 48, 48 rd	BDMAR48048SHGME	1,750	adj glides	standard metal			
custom lower height (specify height)	16 x 16	3" rd	30 x 30, 36 rd	BDMAR30030SLGME	910	adj glides	standard metal		
20 x 20	4" rd	36 x 36, 42 rd	BDMAR36036SLGME	990	adj glides	standard metal			
26 x 26	4" rd	42 x 42, 48 rd	BDMAR42042SLGME	1,170	adj glides	standard metal			
24 x 24	6" rd	48 x 48, 48 rd	BDMAR48048SLGME	1,520	adj glides	standard metal			
	27.75"H	18 x 28	6" rd	36 x 60	BDMAR36060SDGME	1,430	adj glides	standard metal	
		26 x 30	6" rd	42 x 60	BDMAR42060SDGME	1,460	adj glides	standard metal	
	40.75"H	18 x 28	6" rd	36 x 60	BDMAR36060SBGME	1,940	adj glides	standard metal	
		26 x 30	6" rd	42 x 60	BDMAR42060SBGME	2,100	adj glides	standard metal	
	custom higher height (specify height)	18 x 28	6" rd	36 x 60	BDMAR36060SHGME	1,940	adj glides	standard metal	
	24 x 28	6" rd	42 x 60	BDMAR42060SHGME	2,100	adj glides	standard metal		
custom lower height (specify height)	18 x 28	6" rd	36 x 60	BDMAR36060SLGME	1,560	adj glides	standard metal		
26 x 30	6" rd	42 x 60	BDMAR42060SLGME	1,600	adj glides	standard metal			
	27.75"H	16 x 16	3" rd	30 x 30, 36 rd	BDMOL30030SDGME	780	adj glides	standard metal	
		20 x 20	4" rd	36 x 36, 42 rd	BDMOL36036SDGME	860	adj glides	standard metal	
		26 x 26	4" rd	42 x 42, 48 rd	BDMOL42042SDGME	1,030	adj glides	standard metal	
	40.75"H	16 x 16	3" rd	30 x 30, 36 rd	BDMOL30030SBGME	870	adj glides	standard metal	
		20 x 20	4" rd	36 x 36, 42 rd	BDMOL36036SBGME	950	adj glides	standard metal	
		26 x 26	4" rd	42 x 42, 48 rd	BDMOL42042SBGME	1,120	adj glides	standard metal	
	custom higher height (specify height)	16 x 16	3" rd	30 x 30, 36 rd	BDMOL30030SHGME	870	adj glides	standard metal	
	20 x 20	4" rd	36 x 36, 42 rd	BDMOL36036SHGME	950	adj glides	standard metal		
	26 x 26	4" rd	42 x 42, 48 rd	BDMOL42042SHGME	1,120	adj glides	standard metal		
	custom lower height (specify height)	16 x 16	3" rd	30 x 30, 36 rd	BDMOL30030SLGME	870	adj glides	standard metal	
	20 x 20	4" rd	36 x 36, 42 rd	BDMOL36036SLGME	950	adj glides	standard metal		
	26 x 26	4" rd	42 x 42, 48 rd	BDMOL42042SLGME	1,120	adj glides	standard metal		

**Standard metal powder coat finishes (ME)**  
 Black Wrinkle, Chateau Brown Wrinkle, Flat Black, Furniture White, Inner Tone, Light Tone, Medium Tone and Metallic Silver

# bases

## fixed height disc

### Nantes II, Nantes C, Tondo

base	base dim.	column	max top support	base model no.	list	glides	finish		
	27.75"H	17	3" rd	24 x 24, 30 rd	BDNA224024SDGME	770	adj glides	standard metal	
		20	3" rd	30 x 30, 36 rd	BDNA230030SDGME	780	adj glides	standard metal	
		24	4" rd	36 x 36, 42 rd	BDNA236036SDGME	860	adj glides	standard metal	
		32	4" rd	42 x 42, 48 rd	BDNA242042SDGME	1,030	adj glides	standard metal	
		32*	6" rd	48 x 48, 60 rd	BDNA248048SDGME	1,780	adj glides	standard metal	
		40.75"H	17	3" rd	24 x 24, 30 rd	BDNA224024SBGME	860	adj glides	standard metal
	20	3" rd	30 x 30, 36 rd	BDNA230030SBGME	870	adj glides	standard metal		
	24	4" rd	36 x 36, 42 rd	BDNA236036SBGME	950	adj glides	standard metal		
	32	4" rd	42 x 42, 48 rd	BDNA242042SBGME	1,120	adj glides	standard metal		
	32*	6" rd	48 x 48, 60 rd	BDNA248048SBGME	1,870	adj glides	standard metal		
	custom higher height (specify height)	17	3" rd	24 x 24, 30 rd	BDNA224024SHGME	860	adj glides	standard metal	
	20	3" rd	30 x 30, 36 rd	BDNA230030SHGME	870	adj glides	standard metal		
	24	4" rd	36 x 36, 42 rd	BDNA236036SHGME	950	adj glides	standard metal		
	32	4" rd	42 x 42, 48 rd	BDNA242042SHGME	1,120	adj glides	standard metal		
	32*	6" rd	48 x 48, 60 rd	BDNA248048SHGME	1,870	adj glides	standard metal		
	custom lower height (specify height)	17	3" rd	24 x 24, 30 rd	BDNA224024SLGME	860	adj glides	standard metal	
	20	3" rd	30 x 30, 36 rd	BDNA230030SLGME	870	adj glides	standard metal		
	24	4" rd	36 x 36, 42 rd	BDNA236036SLGME	950	adj glides	standard metal		
32	4" rd	42 x 42, 48 rd	BDNA242042SLGME	1,120	adj glides	standard metal			
32*	6" rd	48 x 48, 60 rd	BDNA248048SLGME	1,870	adj glides	standard metal			
	27.75"H	20	3" rd	30 x 30, 36 rd	BDNAC30030SDGPC	1,620	adj glides	polished	
		24	4" rd	36 x 36, 42 rd	BDNAC36036SDGPC	1,720	adj glides	polished	
		32	4" rd	42 x 42, 48 rd	BDNAC42042SDGPC	1,980	adj glides	polished	
		32*	6" rd	48 x 48, 60 rd	BDNAC48048SDGPC	2,400	adj glides	polished	
		40.75"H	20	3" rd	30 x 30, 36 rd	BDNAC30030SBGPC	1,710	adj glides	polished
		24	4" rd	36 x 36, 42 rd	BDNAC36036SBGPC	1,800	adj glides	polished	
	32	4" rd	42 x 42, 48 rd	BDNAC42042SBGPC	2,070	adj glides	polished		
	32*	6" rd	48 x 48, 60 rd	BDNAC48048SBGPC	2,870	adj glides	polished		
	custom higher height (specify height)	20	3" rd	30 x 30, 36 rd	BDNAC30030SHGPC	1,710	adj glides	polished	
	24	4" rd	36 x 36, 42 rd	BDNAC36036SHGPC	1,800	adj glides	polished		
	32	4" rd	42 x 42, 48 rd	BDNAC42042SHGPC	2,070	adj glides	polished		
	32*	6" rd	48 x 48, 60 rd	BDNAC48048SHGPC	2,870	adj glides	polished		
	custom lower height (specify height)	20	3" rd	30 x 30, 36 rd	BDNAC30030SLGPC	1,710	adj glides	polished	
	24	4" rd	36 x 36, 42 rd	BDNAC36036SLGPC	1,800	adj glides	polished		
	32	4" rd	42 x 42, 48 rd	BDNAC42042SLGPC	2,070	adj glides	polished		
	32*	6" rd	48 x 48, 60 rd	BDNAC48048SLGPC	2,870	adj glides	polished		
		27.75"H	22	3" rd	30 x 30, 36 rd	BDTON30030SDGME	870	adj glides	standard metal
			26	3" rd	36 x 36, 42 rd	BDTON36036SDGME	950	adj glides	standard metal
40.75"H		22	3" rd	30 x 30, 36 rd	BDTON30030SBGME	960	adj glides	standard metal	
		26	3" rd	36 x 36, 42 rd	BDTON36036SBGME	1,030	adj glides	standard metal	
custom higher height (specify height)		22	3" rd	30 x 30, 36 rd	BDTON30030SHGME	960	adj glides	standard metal	
26		3" rd	36 x 36, 42 rd	BDTON36036SHGME	1,030	adj glides	standard metal		
custom lower height (specify height)		22	3" rd	30 x 30, 36 rd	BDTON30030SLGME	960	adj glides	standard metal	
26		3" rd	36 x 36, 42 rd	BDTON36036SLGME	1,030	adj glides	standard metal		
27.75"H		22	3" rd	30 x 30, 36 rd	BDTON30030SDGPC	1,360	adj glides	polished	
		26	3" rd	36 x 36, 42 rd	BDTON36036SDGPC	1,500	adj glides	polished	
		40.75"H	22	3" rd	30 x 30, 36 rd	BDTON30030SBGPC	1,450	adj glides	polished
			26	3" rd	36 x 36, 42 rd	BDTON36036SBGPC	1,580	adj glides	polished
	custom higher height (specify height)	22	3" rd	30 x 30, 36 rd	BDTON30030SHGPC	1,450	adj glides	polished	
	26	3" rd	36 x 36, 42 rd	BDTON36036SHGPC	1,580	adj glides	polished		
custom lower height (specify height)	22	3" rd	30 x 30, 36 rd	BDTON30030SLGPC	1,450	adj glides	polished		
26	3" rd	36 x 36, 42 rd	BDTON36036SLGPC	1,580	adj glides	polished			

\*Note that the Nantes II 32 inch disc base with 6 inch column has a cover.

\*Note that the Nantes C 32 inch disc base with 6 inch column has a cover.

**Standard metal powder coat finishes (ME)**  
 Black Wrinkle, Chateau Brown Wrinkle, Flat Black, Furniture White, Inner Tone, Light Tone, Medium Tone and Metallic Silver

**Premium polished finish for Nantes C & Tondo (PC)**

# bases

fixed height disc w/ wire management

Marius, Molly, Nantes II

base	base dim.	column	max top support	base model no.	list	glides	finish	
Marius fixed height square (round column)	27.75"H	16 x 16	3" rd	30 x 30, 36 rd	BDMAR30030PDGME	1,010	adj glides	standard metal
		20 x 20	4" rd	36 x 36, 42 rd	BDMAR36036PDGME	1,090	adj glides	standard metal
		26 x 26	4" rd	42 x 42, 48 rd	BDMAR42042PDGME	1,260	adj glides	standard metal
		24 x 24	6" rd	48 x 48, 48 rd	BDMAR48048PDGME	1,620	adj glides	standard metal
	40.75"H	16 x 16	3" rd	30 x 30, 36 rd	BDMAR30030PBGME	1,140	adj glides	standard metal
		20 x 20	4" rd	36 x 36, 42 rd	BDMAR36036PBGME	1,220	adj glides	standard metal
		26 x 26	4" rd	42 x 42, 48 rd	BDMAR42042PBGME	1,400	adj glides	standard metal
		24 x 24	6" rd	48 x 48, 48 rd	BDMAR48048PBGME	2,160	adj glides	standard metal
	custom higher height (specify height)	16 x 16	3" rd	30 x 30, 36 rd	BDMAR30030PHGME	1,140	adj glides	standard metal
		20 x 20	4" rd	36 x 36, 42 rd	BDMAR36036PHGME	1,220	adj glides	standard metal
		26 x 26	4" rd	42 x 42, 48 rd	BDMAR42042PHGME	1,400	adj glides	standard metal
		24 x 24	6" rd	48 x 48, 48 rd	BDMAR48048PHGME	2,160	adj glides	standard metal
custom lower height (specify height)	16 x 16	3" rd	30 x 30, 36 rd	BDMAR30030PLGME	1,140	adj glides	standard metal	
	20 x 20	4" rd	36 x 36, 42 rd	BDMAR36036PLGME	1,220	adj glides	standard metal	
	26 x 26	4" rd	42 x 42, 48 rd	BDMAR42042PLGME	1,400	adj glides	standard metal	
	24 x 24	6" rd	48 x 48, 48 rd	BDMAR48048PLGME	1,750	adj glides	standard metal	
Marius fixed height rectangle (round column)	27.75"H	18 x 28	6" rd	36 x 60	BDMAR36060PDGME	1,660	adj glides	standard metal
		26 x 30	6" rd	42 x 60	BDMAR42060PDGME	1,690	adj glides	standard metal
	40.75"H	18 x 28	6" rd	36 x 60	BDMAR36060PBGME	2,150	adj glides	standard metal
		26 x 30	6" rd	42 x 60	BDMAR42060PBGME	2,510	adj glides	standard metal
	custom higher height (specify height)	18 x 28	6" rd	36 x 60	BDMAR36060PHGME	2,150	adj glides	standard metal
		24 x 28	6" rd	42 x 60	BDMAR42060PHGME	2,510	adj glides	standard metal
custom lower height (specify height)	18 x 28	6" rd	36 x 60	BDMAR36060PLGME	1,790	adj glides	standard metal	
	26 x 30	6" rd	42 x 60	BDMAR42060PLGME	1,830	adj glides	standard metal	
Molly fixed height (round column)	27.75"H	16 x 16	3" rd	30 x 30, 36 rd	BDMOL30030PDGME	1,010	adj glides	standard metal
		20 x 20	4" rd	36 x 36, 42 rd	BDMOL36036PDGME	1,090	adj glides	standard metal
		26 x 26	4" rd	42 x 42, 48 rd	BDMOL42042PDGME	1,260	adj glides	standard metal
		40.75"H	16 x 16	3" rd	30 x 30, 36 rd	BDMOL30030PBGME	1,100	adj glides
	20 x 20		4" rd	36 x 36, 42 rd	BDMOL36036PBGME	1,180	adj glides	standard metal
	26 x 26		4" rd	42 x 42, 48 rd	BDMOL42042PBGME	1,350	adj glides	standard metal
	custom higher height (specify height)		16 x 16	3" rd	30 x 30, 36 rd	BDMOL30030PHGME	1,100	adj glides
		20 x 20	4" rd	36 x 36, 42 rd	BDMOL36036PHGME	1,180	adj glides	standard metal
		26 x 26	4" rd	42 x 42, 48 rd	BDMOL42042PHGME	1,350	adj glides	standard metal
		custom lower height (specify height)	16 x 16	3" rd	30 x 30, 36 rd	BDMOL30030PLGME	1,100	adj glides
	20 x 20		4" rd	36 x 36, 42 rd	BDMOL36036PLGME	1,180	adj glides	standard metal
	26 x 26		4" rd	42 x 42, 48 rd	BDMOL42042PLGME	1,350	adj glides	standard metal
Nantes II fixed height round disc. (round column)	27.75"H		17	3" rd	24 x 24, 30 rd	BDNA224024PDGME	1,000	adj glides
		20	3" rd	30 x 30, 36 rd	BDNA230030PDGME	1,010	adj glides	standard metal
		24	4" rd	36 x 36, 42 rd	BDNA236036PDGME	1,090	adj glides	standard metal
		32	4" rd	42 x 42, 48 rd	BDNA242042PDGME	1,260	adj glides	standard metal
	40.75"H	17	3" rd	24 x 24, 30 rd	BDNA224024PBGME	1,090	adj glides	standard metal
		20	3" rd	30 x 30, 36 rd	BDNA230030PBGME	1,100	adj glides	standard metal
		24	4" rd	36 x 36, 42 rd	BDNA236036PBGME	1,180	adj glides	standard metal
		32	4" rd	42 x 42, 48 rd	BDNA242042PBGME	1,350	adj glides	standard metal
	custom higher height (specify height)	17	3" rd	24 x 24, 30 rd	BDNA224024PHGME	1,090	adj glides	standard metal
		20	3" rd	30 x 30, 36 rd	BDNA230030PHGME	1,100	adj glides	standard metal
		24	4" rd	36 x 36, 42 rd	BDNA236036PHGME	1,180	adj glides	standard metal
		32	4" rd	42 x 42, 48 rd	BDNA242042PHGME	1,350	adj glides	standard metal
custom lower height (specify height)	17	3" rd	24 x 24, 30 rd	BDNA224024PLGME	1,090	adj glides	standard metal	
	20	3" rd	30 x 30, 36 rd	BDNA230030PLGME	1,100	adj glides	standard metal	
	24	4" rd	36 x 36, 42 rd	BDNA236036PLGME	1,180	adj glides	standard metal	
	32	4" rd	42 x 42, 48 rd	BDNA242042PLGME	1,350	adj glides	standard metal	

**Standard metal powder coat finishes (ME):**

Black Wrinkle, Chateau Brown Wrinkle, Flat Black, Furniture White, Inner Tone, Light Tone, Medium Tone and Metallic Silver



open top plate for 3" and 4" column  
Marius, Molly and Nantes bases



enclosed top plate for 6" column  
Marius bases

# bases

Tondo fixed ht disc w/ wire mgmt disc

Bennett, Nantes II, Tondo pneumatic height adj disc

base	base dim.	column	max top support	base model no.	list	glides	finish	
Tondo fixed height (round column)	27.75"H	22	3" rd	30 x 30, 36 rd	BDTON30030PDGME	1,720	adj glides	standard metal
		26	3" rd	36 x 36, 42 rd	BDTON36036PDGME	1,860	adj glides	standard metal
	40.75"H	22	3" rd	30 x 30, 36 rd	BDTON30030PBGME	1,800	adj glides	standard metal
		26	3" rd	36 x 36, 42 rd	BDTON36036PBGME	1,940	adj glides	standard metal
		22	3" rd	30 x 30, 36 rd	BDTON30030PHGME	1,800	adj glides	standard metal
		26	3" rd	36 x 36, 42 rd	BDTON36036PHGME	1,940	adj glides	standard metal
custom higher height (specify height)	22	3" rd	30 x 30, 36 rd	BDTON30030PLGME	1,800	adj glides	standard metal	
	26	3" rd	36 x 36, 42 rd	BDTON36036PLGME	1,940	adj glides	standard metal	



custom higher height (specify height)  
custom lower height (specify height)

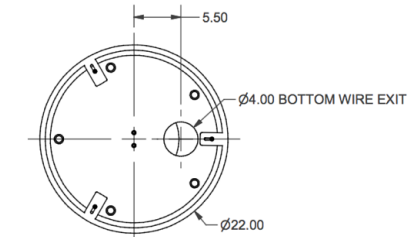
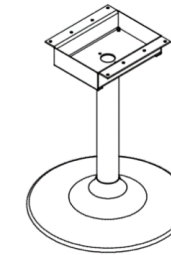

**Standard metal powder coat finishes (ME):**

Black Wrinkle (BW), Chateau Brown Wrinkle (CB), Flat Black (FB), Furniture White (FW), Inner Tone (IT), Light Tone (LT), Medium Tone (MT), Metallic Silver (MS).

**Bennett pneumatic adj ht (square column)**



16 x 16	sq	30 x 30, 36 rd	BDBEN30030SPGME	1,530	adj glides	standard metal
20 x 20	sq	36 x 36, 42 rd	BDBEN36036SPGME	1,620	adj glides	standard metal
26 x 26	sq	42 x 42, 48 rd	BDBEN42042SPGME	1,780	adj glides	standard metal

**Nantes II pneumatic adj ht (round column)**



20	rd	30 x 30, 36 rd	BDNA230030SPGME	1,470	adj glides	standard metal
24	rd	36 x 36, 42 rd	BDNA236036SPGME	1,890	adj glides	standard metal
32	rd	42 x 42, 48 rd	BDNA242042SPGME	2,070	adj glides	standard metal

Bennett & Nantes II lift capacity can be set at 33, 44, 55 or 66 lbs. for a lift range between 28 - 76 lbs. See chart for details:

**AVAILABLE LIFT CAPACITY**

Specify	Pound Equivalent	Lift Range
150N	33 lbs.	28-38 lbs.
200N	44 lbs.	34-54 lbs.
250N	55 lbs.	45-65 lbs.
300N	66 lbs.	56-76 lbs.

**Tondo pneumatic adj ht (round column)**



22	rd	30 x 30, 36 rd	BDTON30030SPGME	1,940	adj glides	standard metal
26	rd	36 x 36, 42 rd	BDTON36036SPGME	2,460	adj glides	standard metal

Tondo lift capacity can be set at 22, 33, or 44 lbs. for a lift range between 18 - 54 lbs. See chart for details:

**AVAILABLE LIFT CAPACITY**

Specify	Pound Equivalent	Lift Range
100N	22 lbs.	18-28 lbs.
150N	33 lbs.	28-38 lbs.
200N	44 lbs.	34-54 lbs.

**Pneumatic Adjustable Height Standard metal powder coat finishes (ME):**

Flat Black, Furniture White, and Metallic Silver

**Bennett, Nantes II and Tondo Pneumatic Height Adjustable Bases**

P<sub>2</sub> Glide (plastic glide guidance) or Roller (steel roller guidance) Lift height adjustment: 26.75" - 44.5" base height range (without table top) pneumatic cylinder assist with infinite stop positions, no bounce cylinder stop, and unintentional release resistant lever with cable release

The weight of the top and all accessories that will be used on the base shall be advised on the purchase order. If the weight is set wrong then it will cause the table to lift up to fast or not work at all. Contact service@symphonytables.com for assistance.

# bases

## occasional

Bennett, Keller, Marius, Molly, Moto, Nantes II, Nantes C, Ria, Tondo, Zoey

base	base dim.	column	max top support	base model no.	list	finish
Bennett (square column)	16 x 16	3" sq	30 x 30, 36 rd	BDBEN30030SLGME	870	standard metal
	20 x 20	3" sq	36 x 36, 42 rd	BDBEN36036SLGME	950	standard metal
	26 x 26	3" sq	42 x 42, 48 rd	BDBEN42042SLGME	1,120	standard metal
Keller occasional	15.25 x 15.25 x 15H	2.25"	20 rd	BXKEL2002015GME	550	standard metal
	15.25 x 15.25 x 17H	2.25"	20 rd	BXKEL2002017GME	550	standard metal
	15.25 x 15.25 x 19H	2.25"	20 rd	BXKEL2002019GME	550	standard metal
	15.25 x 15.25 x 15H	2.25"	20 rd	BXKEL2002015GPO	700	polished
	15.25 x 15.25 x 17H	2.25"	20 rd	BXKEL2002017GPO	700	polished
	15.25 x 15.25 x 19H	2.25"	20 rd	BXKEL2002019GPO	700	polished
Keller (round column)	20 x 20	2.25" rd	24 x 24, 24 rd	BXKEL24024SLGME	620	standard metal
	26 x 26	2.25" rd	30 x 30, 36 rd	BXKEL30030SLGME	680	standard metal
	33 x 33	2.25" rd	36 x 36, 42 rd	BXKEL36036SLGME	750	standard metal
	38 x 38	2.25" rd	42 x 42, 48 rd	BXKEL42042SLGME	880	standard metal
	20 x 20	2.25" rd	24 x 24, 24 rd	BXKEL24024SLGPO	770	polished
	26 x 26	2.25" rd	30 x 30, 36 rd	BXKEL30030SLGPO	830	polished
	33 x 33	2.25" rd	36 x 36, 42 rd	BXKEL36036SLGPO	900	polished
	38 x 38	2.25" rd	42 x 42, 48 rd	BXKEL42042SLGPO	1,020	polished
Marius (round column)	16 x 16	3" rd	30 x 30, 36 rd	BDMAR30030SLGME	910	standard metal
	20 x 20	4" rd	36 x 36, 42 rd	BDMAR36036SLGME	990	standard metal
	26 x 26	4" rd	42 x 42, 48 rd	BDMAR42042SLGME	1,170	standard metal
	24 x 24	6" rd	48 x 48, 48 rd	BDMAR48048SLGME	1,520	standard metal
rectangle disc	18 x 28	6" rd	36 x 60	BDMAR36060SLGME	1,560	standard metal
	26 x 30	6" rd	42 x 60	BDMAR42060SLGME	1,600	standard metal
Molly (round column)	16 x 16	3" rd	30 x 30, 36 rd	BDMOL30030SLGME	870	standard metal
	20 x 20	4" rd	36 x 36, 42 rd	BDMOL36036SLGME	950	standard metal
	26 x 26	4" rd	42 x 42, 48 rd	BDMOL42042SLGME	1,120	standard metal
Moto (square column)	22 x 22	3" sq	24 x 24, 24 rd	BXMOT24024SLGME	750	standard metal
	26 x 26	3" sq	30 x 30, 36 rd	BXMOT30030SLGME	790	standard metal
	32 x 32	3" sq	36 x 36, 42 rd	BXMOT36036SLGME	850	standard metal
	36 x 36	3" sq	42 x 42, 48 rd	BXMOT42042SLGME	870	standard metal
Nantes II (round column)	20 dia.	3" rd	30 x 30, 36 rd	BDNA230030SLGME	870	standard metal
	24 dia.	4" rd	36 x 36, 42 rd	BDNA236036SLGME	950	standard metal
	32 dia.	4" rd	42 x 42, 48 rd	BDNA242042SLGME	1,120	standard metal
Nantes C with cover (round column)	20 dia.	3" rd	30 x 30, 36 rd	BDNAC30030SLGPC	1,710	polished
	24 dia.	4" rd	36 x 36, 42 rd	BDNAC36036SLGPC	1,800	polished
	32 dia.	4" rd	42 x 42, 48 rd	BDNAC42042SLGPC	2,070	polished
Ria (round column)	20 x 20	2.25" rd	24 x 24, 24 rd	BXRIA24024SLGME	590	standard metal
	26 x 26	2.25" rd	30 x 30, 36 rd	BXRIA30030SLGME	640	standard metal
	33 x 33	2.25" rd	36 x 36, 42 rd	BXRIA36036SLGME	720	standard metal
	38 x 38	2.25" rd	42 x 42, 48 rd	BXRIA42042SLGME	840	standard metal
	20 x 20	2.25" rd	24 x 24, 24 rd	BXRIA24024SLGPO	690	polished
	26 x 26	2.25" rd	30 x 30, 36 rd	BXRIA30030SLGPO	730	polished
33 x 33	2.25" rd	36 x 36, 42 rd	BXRIA36036SLGPO	810	polished	
38 x 38	2.25" rd	42 x 42, 48 rd	BXRIA42042SLGPO	920	polished	
Tondo	22 dia.	3" rd	30 x 30, 36 rd	BDTON30030SLGME	960	standard metal
	26 dia.	3" rd	36 x 36, 42 rd	BDTON36036SLGME	1,030	standard metal
	22 dia.	3" rd	30 x 30, 36 rd	BDTON30030SLGPC	1,450	polished
	26 dia.	3" rd	36 x 36, 42 rd	BDTON36036SLGPC	1,580	polished
Zoey	21 x 21	n/a	24 x 24, 24 rd	BXZOE24024SLGME	720	standard metal
	27 x 27	n/a	30 x 30, 36 rd	BXZOE30030SLGME	750	standard metal
	33 x 33	n/a	36 x 36, 42 rd	BXZOE36036SLGME	780	standard metal

L Specify custom lower base height. Note that a standard PVEA PVC edge top will add 1.25" to the overall height of the table

### Examples:

16.75" base height + 1.25" top thickness = 18" overall table height  
18.75" base height + 1.25" top thickness = 20" overall table height  
22.75" base height + 1.25" top thickness = 24" overall table height

### (ME) Standard metal powder coat finishes :

Black Wrinkle (BW), Chateau Brown Wrinkle (CB), Flat Black (FB), Furniture White (FW), Inner Tone (IT), Light Tone (LT), Medium Tone (MT), Metallic Silver (MS).

### (PC) Polished chrome finish (Nantes / Tondo)

### (PO) Polished aluminum / chrome finish (Keller / Ria)

# bases

## occasional

Nora

base	base dim.	column	max top support	base model no.	list	finish	
Nora occasional	round	14 dia. x 15H	1.5" centered	20 rd	BDNOR20RD15CGME	910	standard metal
		14 dia. x 17H	1.5" centered	20 rd	BDNOR20RD17CGME	910	standard metal
		14 dia. x 19H	1.5" centered	20 rd	BDNOR20RD19CGME	910	standard metal
		14 dia. x 21H	1.5" centered	20 rd	BDNOR20RD21CGME	910	standard metal
		18 dia. x 15H	1.5" centered	30 rd	BDNOR30RD15CGME	1,050	standard metal
	18 dia. x 17H	1.5" centered	30 rd	BDNOR30RD17CGME	1,050	standard metal	
	18 dia. x 19H	1.5" centered	30 rd	BDNOR30RD19CGME	1,050	standard metal	
	18 dia. x 21H	1.5" centered	30 rd	BDNOR30RD21CGME	1,050	standard metal	
	23 dia. x 15H	3" centered	42 rd	BDNOR42RD15CGME	1,150	standard metal	
	23 dia. x 17H	3" centered	42 rd	BDNOR42RD17CGME	1,150	standard metal	
	23 dia. x 19H	3" centered	42 rd	BDNOR42RD19CGME	1,150	standard metal	
	23 dia. x 21H	3" centered	42 rd	BDNOR42RD21CGME	1,150	standard metal	
	rounded square	14 dia. x 15H	1.5" centered	20 rd	BDNOR20RD15CGPC	1,200	polished
		14 dia. x 17H	1.5" centered	20 rd	BDNOR20RD17CGPC	1,200	polished
		14 dia. x 19H	1.5" centered	20 rd	BDNOR20RD19CGPC	1,200	polished
14 dia. x 21H		1.5" centered	20 rd	BDNOR20RD21CGPC	1,200	polished	
18 dia. x 15H		1.5" centered	30 rd	BDNOR30RD15CGPC	1,380	polished	
18 dia. x 17H		1.5" centered	30 rd	BDNOR30RD17CGPC	1,380	polished	
18 dia. x 19H		1.5" centered	30 rd	BDNOR30RD19CGPC	1,380	polished	
18 dia. x 21H		1.5" centered	30 rd	BDNOR30RD21CGPC	1,380	polished	
23 dia. x 15H		3" centered	42 rd	BDNOR42RD15CGPC	1,630	polished	
23 dia. x 17H		3" centered	42 rd	BDNOR42RD17CGPC	1,630	polished	
rounded rectangle	23 dia. x 19H	3" centered	42 rd	BDNOR42RD19CGPC	1,630	polished	
	23 dia. x 21H	3" centered	42 rd	BDNOR42RD21CGPC	1,630	polished	
	15.5 x 15.5 x 15H	1.5" centered	24 sq	BDNOR24RS15CGME	970	standard metal	
	15.5 x 15.5 x 17H	1.5" centered	24 sq	BDNOR24RS17CGME	970	standard metal	
	15.5 x 15.5 x 19H	1.5" centered	24 sq	BDNOR24RS19CGME	970	standard metal	
	15.5 x 15.5 x 21H	1.5" centered	24 sq	BDNOR24RS21CGME	970	standard metal	
	18 x 18 x 15H	3" centered	36 sq	BDNOR36RS15CGME	1,050	standard metal	
	18 x 18 x 17H	3" centered	36 sq	BDNOR36RS17CGME	1,050	standard metal	
	18 x 18 x 19H	3" centered	36 sq	BDNOR36RS19CGME	1,050	standard metal	
	18 x 18 x 21H	3" centered	36 sq	BDNOR36RS21CGME	1,050	standard metal	

### (ME) Standard metal powder coat finishes (Nora)

Black Wrinkle (BW), Chateau Brown Wrinkle (CB), Flat Black (FB), Furniture White (FW), Inner Tone (IT), Light Tone (LT), Medium Tone (MT), Metallic Silver (MS).

### (PC) Polished chrome finish (Nora round bases only)





### FIXED BASE HEIGHT + 1.25" THICK TOP DIMENSIONS

#### Examples:

15" base height + 1.25" top thickness = 16.25" overall table height  
17" base height + 1.25" top thickness = 18.25" overall table height  
19" base height + 1.25" top thickness = 20.25" overall table height  
21" base height + 1.25" top thickness = 22.25" overall table height



bases  
conference sets  
Bassa

base	base dim.	qty	max top support	base set model no.	list	finish	
<b>Bassa</b>							
rectangular frame 	solid metal panel	18 x 6 x 27.75	2 36 x 96	BFBAS36096REGSM	3,980	standard metal	
	18 x 6 x 27.75	3 36 x 144	BFBAS36144REGSM	5,960	standard metal		
	18 x 6 x 27.75	4 36 x 192	BFBAS36192REGSM	7,950	standard metal		
	24 x 6 x 27.75	2 48 x 96	BFBAS48096REGSM	4,070	standard metal		
	24 x 6 x 27.75	3 48 x 144	BFBAS48144REGSM	6,130	standard metal		
	24 x 6 x 27.75	4 48 x 192	BFBAS48192REGSM	8,170	standard metal		
	34 x 6 x 27.75	2 60 x 96	BFBAS60096REGSM	4,330	standard metal		
	34 x 6 x 27.75	3 60 x 144	BFBAS60144REGSM	6,520	standard metal		
	34 x 6 x 27.75	4 60 x 192	BFBAS60192REGSM	8,700	standard metal		
	perforated metal panel 	perforated metal panel	18 x 6 x 27.75	2 36 x 96	BFBAS36096REGPM	4,040	standard metal
		18 x 6 x 27.75	3 36 x 144	BFBAS36144REGPM	6,070	standard metal	
		18 x 6 x 27.75	4 36 x 192	BFBAS36192REGPM	8,090	standard metal	
		24 x 6 x 27.75	2 48 x 96	BFBAS48096REGPM	4,140	standard metal	
		24 x 6 x 27.75	3 48 x 144	BFBAS48144REGPM	6,200	standard metal	
		24 x 6 x 27.75	4 48 x 192	BFBAS48192REGPM	8,270	standard metal	
34 x 6 x 27.75		2 60 x 96	BFBAS60096REGPM	4,620	standard metal		
34 x 6 x 27.75		3 60 x 144	BFBAS60144REGPM	6,920	standard metal		
34 x 6 x 27.75		4 60 x 192	BFBAS60192REGPM	9,220	standard metal		
<b>Bassa</b>							
curved frame 	solid metal panel	20 x 6 x 27.75	2 36 x 96	BFBAS36096CUGSM	3,970	standard metal	
	20 x 6 x 27.75	3 36 x 144	BFBAS36144CUGSM	5,950	standard metal		
	20 x 6 x 27.75	4 36 x 192	BFBAS36192CUGSM	7,930	standard metal		
	26 x 6 x 27.75	2 48 x 96	BFBAS48096CUGSM	4,050	standard metal		
	26 x 6 x 27.75	3 48 x 144	BFBAS48144CUGSM	6,080	standard metal		
	26 x 6 x 27.75	4 48 x 192	BFBAS48192CUGSM	8,110	standard metal		
	36 x 6 x 27.75	2 60 x 96	BFBAS60096CUGSM	4,520	standard metal		
	36 x 6 x 27.75	3 60 x 144	BFBAS60144CUGSM	6,780	standard metal		
	36 x 6 x 27.75	4 60 x 192	BFBAS60192CUGSM	9,030	standard metal		
	perforated metal panel 	perforated metal panel	20 x 6 x 27.75	2 36 x 96	BFBAS36096CUGPM	4,020	standard metal
		20 x 6 x 27.75	3 36 x 144	BFBAS36144CUGPM	6,030	standard metal	
		20 x 6 x 27.75	4 36 x 192	BFBAS36192CUGPM	8,030	standard metal	
		26 x 6 x 27.75	2 48 x 96	BFBAS48096CUGPM	4,110	standard metal	
		26 x 6 x 27.75	3 48 x 144	BFBAS48144CUGPM	6,170	standard metal	
		26 x 6 x 27.75	4 48 x 192	BFBAS48192CUGPM	8,220	standard metal	
36 x 6 x 27.75		2 60 x 96	BFBAS60096CUGPM	4,510	standard metal		
36 x 6 x 27.75		3 60 x 144	BFBAS60144CUGPM	6,780	standard metal		
36 x 6 x 27.75		4 60 x 192	BFBAS60192CUGPM	9,030	standard metal		

**(ME) Standard metal powder coat finishes (Bassa)**

Flat Black (FB), Furniture White (FW), Inner Tone (IT), Light Tone (LT), Medium Tone (MT), Metallic Silver (MS).

\*laminated panels are available for Bassa, email [service@symphonytables.com](mailto:service@symphonytables.com) for pricing

bases  
conference sets  
Lastra

base	base dim.	qty	max top support	base set model no.	list	laminata grade
Lastra 6" rectangle 	27.75"H 18 x 6	2	42 x 96	BLLAR420962DGL1	1,570	1
		3	42 x 144	BLLAR421443DGL1	2,360	1
		4	42 x 192	BLLAR421924DGL1	3,140	1
	18 x 6	2	42 x 96	BLLAR420962DGL2	1,830	2
		3	42 x 144	BLLAR421443DGL2	2,740	2
		4	42 x 192	BLLAR421924DGL2	3,660	2
	24 x 6	2	48 x 96	BLLAR480962DGL1	1,800	1
		3	48 x 144	BLLAR481443DGL1	2,700	1
		4	48 x 192	BLLAR481924DGL1	3,600	1
	24 x 6	2	48 x 96	BLLAR480962DGL2	2,100	2
		3	48 x 144	BLLAR481443DGL2	3,150	2
		4	48 x 192	BLLAR481924DGL2	4,190	2
	30 x 6	2	60 x 96	BLLAR600962DGL1	2,100	1
		3	60 x 144	BLLAR601443DGL1	3,160	1
		4	60 x 192	BLLAR601924DGL1	4,210	1
	30 x 6	2	60 x 96	BLLAR600962DGL2	2,460	2
		3	60 x 144	BLLAR601443DGL2	3,700	2
		4	60 x 192	BLLAR601924DGL2	4,920	2

base	base dim.	qty	max top support	base set model no.	list	laminata grade
Lastra 12" rectangle 	27.75"H 18 x 12	2	42 x 108	BLLAR421082DGL1	1,910	1
		3	42 x 156	BLLAR421563DGL1	2,870	1
		4	42 x 228	BLLAR422284DGL1	3,830	1
	18 x 12	2	42 x 108	BLLAR421082DGL2	2,240	2
		3	42 x 156	BLLAR421563DGL2	3,360	2
		4	42 x 228	BLLAR422284DGL2	4,480	2
	24 x 12	2	48 x 108	BLLAR481082DGL1	2,150	1
		3	48 x 156	BLLAR481563DGL1	3,220	1
		4	48 x 228	BLLAR482284DGL1	4,300	1
	24 x 12	2	48 x 108	BLLAR481082DGL2	2,510	2
		3	48 x 156	BLLAR481563DGL2	3,770	2
		4	48 x 228	BLLAR482284DGL2	5,030	2
	30 x 12	2	60 x 108	BLLAR601082DGL1	2,480	1
		3	60 x 156	BLLAR601563DGL1	3,720	1
		4	60 x 228	BLLAR602284DGL1	4,960	1
	30 x 12	2	60 x 108	BLLAR601082DGL2	2,900	2
		3	60 x 156	BLLAR601563DGL2	4,350	2
		4	60 x 228	BLLAR602284DGL2	5,800	2

base	base dim.	qty	max top support	base set model no.	list	laminata grade
Lastra square 	27.75"H 18 x 18	2	42 x 120	BLLAS42120D2GL1	2,270	1
		3	42 x 192	BLLAS42192D3GL1	3,400	1
		2	42 x 120	BLLAS42120D2GL2	2,670	2
		3	42 x 192	BLLAS42192D3GL2	4,000	2
		2	48 x 132	BLLAS48132D2GL1	2,420	1
		3	48 x 204	BLLAS48204D3GL1	3,630	1
	24 x 24	2	48 x 132	BLLAS48132D2GL2	2,830	2
		3	48 x 204	BLLAS48204D3GL2	4,240	2
		2	60 x 144	BLLAS60144D2GL1	2,810	1
		3	60 x 216	BLLAS60216D3GL1	4,220	1
		2	60 x 144	BLLAS60144D2GL2	3,290	2
		3	60 x 216	BLLAS60216D3GL2	4,940	2

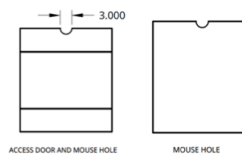



**Lastra hinged access door option:**  
14.75"H hinged access door (1) for a seated height base, model # OBLASDH129 - \$190 list each

\*Lastra wire management mouse holes come on BOTH SIDES at the top / center of all bases in the set unless the base is specified with no wire management mouse holes, please indicate that you do not want mouse holes on one or both sides of the base in **bold face ALL CAPS** on your PO.

\* Lastra rectangle and square interior base dimensions are 1.5" less than the "W x D" dimension listed above for each base  
\* the bottom of the Lastra base is open to the floor

bases  
conference sets  
Lastra

base	base dim.	qty	max top support	base set model no.	list	laminata grade
Lastra 6" rectangle 	40.75"H 18 x 6	2	42 x 96	BLLAR420962HGL1	1,910	1
		3	42 x 144	BLLAR421443HGL1	2,870	1
		4	42 x 192	BLLAR421924HGL1	3,840	1
	18 x 6	2	42 x 96	BLLAR420962HGL2	2,260	2
		3	42 x 144	BLLAR421443HGL2	3,390	2
		4	42 x 192	BLLAR421924HGL2	4,510	2
	24 x 6	2	48 x 96	BLLAR480962HGL1	2,210	1
		3	48 x 144	BLLAR481443HGL1	3,130	1
		4	48 x 192	BLLAR481924HGL1	4,180	1
	24 x 6	2	48 x 96	BLLAR480962HGL2	2,440	2
		3	48 x 144	BLLAR481443HGL2	3,660	2
		4	48 x 192	BLLAR481924HGL2	4,880	2
	30 x 6	2	60 x 96	BLLAR600962HGL1	2,430	1
		3	60 x 144	BLLAR601443HGL1	3,650	1
		4	60 x 192	BLLAR601924HGL1	4,870	1
	30 x 6	2	60 x 96	BLLAR600962HGL2	2,850	2
		3	60 x 144	BLLAR601443HGL2	4,270	2
		4	60 x 192	BLLAR601924HGL2	5,690	2

base	base dim.	qty	max top support	base set model no.	list	laminata grade
Lastra 12" rectangle 	40.75"H 18 x 12	2	42 x 108	BLLAR421082HGL1	2,260	1
		3	42 x 156	BLLAR421563HGL1	3,380	1
		4	42 x 228	BLLAR422284HGL1	4,500	1
	18 x 12	2	42 x 108	BLLAR421082HGL2	2,660	2
		3	42 x 156	BLLAR421563HGL2	3,990	2
		4	42 x 228	BLLAR422284HGL2	5,320	2
	24 x 12	2	48 x 108	BLLAR481082HGL1	2,660	1
		3	48 x 156	BLLAR481563HGL1	3,990	1
		4	48 x 228	BLLAR482284HGL1	5,320	1
	24 x 12	2	48 x 108	BLLAR481082HGL2	3,140	2
		3	48 x 156	BLLAR481563HGL2	4,720	2
		4	48 x 228	BLLAR482284HGL2	6,280	2
	30 x 12	2	60 x 108	BLLAR601082HGL1	3,400	1
		3	60 x 156	BLLAR601563HGL1	5,090	1
		4	60 x 228	BLLAR602284HGL1	6,800	1
	30 x 12	2	60 x 108	BLLAR601082HGL2	4,020	2
		3	60 x 156	BLLAR601563HGL2	6,030	2
		4	60 x 228	BLLAR602284HGL2	8,020	2

base	base dim.	qty	max top support	base set model no.	list	laminata grade
Lastra square 	40.75"H 18 x 18	2	42 x 120	BLLAS42120H2GL1	2,520	1
		3	42 x 192	BLLAS42192H3GL1	3,780	1
		2	42 x 120	BLLAS42120H2GL2	2,970	2
		3	42 x 192	BLLAS42192H3GL2	4,450	2
		2	48 x 132	BLLAS48132H2GL1	2,630	1
		3	48 x 204	BLLAS48204H3GL1	3,950	1
	24 x 24	2	48 x 132	BLLAS48132H2GL2	3,090	2
		3	48 x 204	BLLAS48204H3GL2	4,630	2
		2	60 x 144	BLLAS60144H2GL1	3,280	1
		3	60 x 216	BLLAS60216H3GL1	4,920	1
		2	60 x 144	BLLAS60144H2GL2	3,850	2
		3	60 x 216	BLLAS60216H3GL2	5,780	2

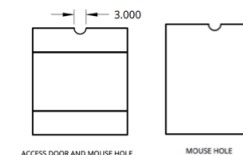

**Lastra hinged access door option:**  
15.75"H hinged access door (1) for a standing height base, model # OBLASDH142 - \$210 list each

\*Lastra wire management mouse holes come on BOTH SIDES at the top / center of all bases in the set unless the base is specified with no wire management mouse holes, please indicate that you do not want mouse holes on one or both sides of the base in **bold face ALL CAPS** on your PO.

\* Lastra rectangle and square interior base dimensions are 1.5" less than the "W x D" dimension listed above for each base  
\* the bottom of the Lastra base is open to the floor

bases  
conference sets  
Tambo cylinder

base	base dim.	qty	max top support	base set model no.	list	lamine grade	
Tambo cylinder 	27.75"H	2	42 x 120	BLTAM42120D2GL1	2,240	1	
		3	42 x 192	BLTAM42192D3GL1	3,380	1	
		2	42 x 120	BLTAM42120D2GL2	2,440	2	
		3	42 x 192	BLTAM42192D3GL2	3,690	2	
		2	48 x 132	BLTAM48132D2GL1	2,960	1	
		3	48 x 204	BLTAM48204D3GL1	4,430	1	
		2	48 x 132	BLTAM48132D2GL2	3,220	2	
		3	48 x 204	BLTAM48204D3GL2	4,840	2	
		2	60 x 144	BLTAM60144D2GL1	3,510	1	
		3	60 x 216	BLTAM60216D3GL1	5,250	1	
		2	60 x 144	BLTAM60144D2GL2	3,820	2	
		3	60 x 216	BLTAM60216D3GL2	5,730	2	
		40.75"H	2	42 x 120	BLTAM42120H2GL1	2,650	1
			3	42 x 192	BLTAM42192H3GL1	3,980	1
			2	42 x 120	BLTAM42120H2GL2	2,880	2
			3	42 x 192	BLTAM42192H3GL2	4,330	2
			2	48 x 132	BLTAM48132H2GL1	3,480	1
			3	48 x 204	BLTAM48204H3GL1	5,210	1
2	48 x 132		BLTAM48132H2GL2	3,800	2		
3	48 x 204		BLTAM48204H3GL2	5,690	2		
2	60 x 144		BLTAM60144H2GL1	4,130	1		
3	60 x 216		BLTAM60216H3GL1	6,180	1		
2	60 x 144		BLTAM60144H2GL2	4,490	2		
3	60 x 216		BLTAM60216H3GL2	6,730	2		

**Tambo laminate base options:**

10 x 10 side hinged curved access door for a cylinder base, model # **OBLTAMWMD** - \$830 list per door  
50 LB ballast bag (14x24x3H plastic rip stop material bag filled with small pebbles/stones), model # **OBLTAMBAL** - \$230 list per bag

\* Tambo cylinder bases have 4 metal top plates to mount the base to the top, there is a 10.5" hole centered at the top of the base and a 9.5" hole centered at the bottom of the base. Tambo bases do not come with wire management mouse holes.

# bases

## under table media

base	base length	qty	base model no.	list	laminate grade		
6" under table media	27.75"H	36	1	AMW360628FUT1	1,310	1	
		42	1	AMW420628FUT1	1,770	1	
		48	1	AMW480628FUT1	1,820	1	
		54	1	AMW540628FUT1	2,130	1	
		60	1	AMW600628FUT1	2,180	1	
		36	1	AMW360628FUT2	1,540	2	
	42	1	AMW420628FUT2	2,080	2		
	48	1	AMW480628FUT2	2,130	2		
	54	1	AMW540628FUT2	2,500	2		
	60	1	AMW600628FUT2	2,550	2		
	34.75"H	COUNTER HEIGHT	36	1	AMW360635FUT1	1,670	1
			42	1	AMW420635FUT1	2,240	1
48			1	AMW480635FUT1	2,290	1	
54			1	AMW540635FUT1	2,680	1	
60			1	AMW600635FUT1	2,730	1	
36			1	AMW360635FUT2	1,970	2	
42		1	AMW420635FUT2	2,640	2		
48		1	AMW480635FUT2	2,690	2		
54		1	AMW540635FUT2	3,150	2		
60		1	AMW600635FUT2	3,190	2		
40.75"H		STANDING HEIGHT	36	1	AMW360641FUT1	2,120	1
			42	1	AMW420641FUT1	2,830	1
	48		1	AMW480641FUT1	2,880	1	
	54		1	AMW540641FUT1	3,360	1	
	60		1	AMW600641FUT1	3,410	1	
	36		1	AMW360641FUT2	2,490	2	
	42	1	AMW420641FUT2	3,340	2		
	48	1	AMW480641FUT2	3,380	2		
	54	1	AMW540641FUT2	3,950	2		
	60	1	AMW600641FUT2	4,000	2		

Please specify a back option:



SOLID BACK

model number **OMWSOBK - \$0 list**

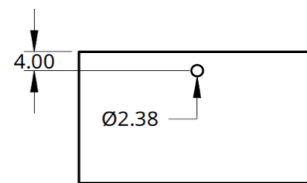

BACK WITH (1) GROMMET

model number **OMWGR1BK - \$30 list**

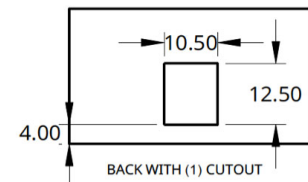

BACK WITH (1) CUTOUT

model number **OMWCO1BK - \$50 list**

\*Note that top will be modified to fit the base if it is a tapering top. The wall end of the top will be 6" rectangle and then the top will start to taper.

# bases

## under table media

base	base length	qty	base model no.	list	laminate grade		
12" under table media	27.75"H	36	1	AMW361228FUT1	1,410	1	
		42	1	AMW421228FUT1	1,940	1	
		48	1	AMW481228FUT1	1,990	1	
		54	1	AMW541228FUT1	2,380	1	
		60	1	AMW601228FUT1	2,430	1	
		36	1	AMW361228FUT2	1,660	2	
	42	1	AMW421228FUT2	2,290	2		
	48	1	AMW481228FUT2	2,330	2		
	54	1	AMW541228FUT2	2,800	2		
	60	1	AMW601228FUT2	2,840	2		
	34.75"H	COUNTER HEIGHT	36	1	AMW361235FUT1	1,800	1
			42	1	AMW421235FUT1	2,460	1
48			1	AMW481235FUT1	2,500	1	
54			1	AMW541235FUT1	2,990	1	
60			1	AMW601235FUT1	3,040	1	
36			1	AMW361235FUT2	2,110	2	
42		1	AMW421235FUT2	2,900	2		
48		1	AMW481235FUT2	2,940	2		
54		1	AMW541235FUT2	3,520	2		
60		1	AMW601235FUT2	3,570	2		
40.75"H		STANDING HEIGHT	36	1	AMW361241FUT1	2,270	1
			42	1	AMW421241FUT1	3,100	1
	48		1	AMW481241FUT1	3,150	1	
	54		1	AMW541241FUT1	3,760	1	
	60		1	AMW601241FUT1	3,800	1	
	36		1	AMW361241FUT2	2,680	2	
	42	1	AMW421241FUT2	3,660	2		
	48	1	AMW481241FUT2	3,710	2		
	54	1	AMW541241FUT2	4,430	2		
	60	1	AMW601241FUT2	4,480	2		

Please specify a back option:



SOLID BACK

model number **OMWSOBK - \$0 list**

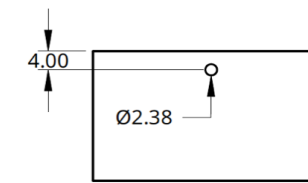

BACK WITH (1) GROMMET

model number **OMWGR1BK - \$30 list**

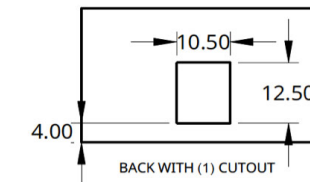

BACK WITH (1) CUTOUT

model number **OMWCO1BK - \$50 list**

\*Note that top will be modified to fit the base if it is a tapering top. The wall end of the top will be 6" rectangle and then the top will start to taper.

# Media Wall

## 6" deep

media wall	SEATED HEIGHT MEDIA WALL FRONT	72"H	wall length	qty	wall model no.	list	laminate grade
6" deep media wall		72"H	36	1	AMW360672FWM1	2,610	1
			42	1	AMW420672FWM1	3,160	1
			48	1	AMW480672FWM1	3,260	1
			54	1	AMW540672FWM1	3,890	1
			60	1	AMW600672FWM1	3,980	1
		84"H	36	1	AMW360684FWM1	3,120	1
			42	1	AMW420684FWM1	3,780	1
			48	1	AMW480684FWM1	3,870	1
			54	1	AMW540684FWM1	4,760	1
			60	1	AMW600684FWM1	4,850	1
			36	1	AMW360684FWM2	3,600	2
			42	1	AMW420684FWM2	4,370	2
			48	1	AMW480684FWM2	4,470	2
			54	1	AMW540684FWM2	5,490	2
			60	1	AMW600684FWM2	5,580	2

# Media Wall

## 12" deep

media wall	SEATED HEIGHT MEDIA WALL FRONT	72"H	wall length	qty	wall model no.	list	laminate grade
12" deep media wall		72"H	36	1	AMW361272FWM1	3,590	1
			42	1	AMW421272FWM1	4,370	1
			48	1	AMW481272FWM1	4,470	1
			54	1	AMW541272FWM1	5,300	1
			60	1	AMW601272FWM1	5,390	1
		84"H	36	1	AMW361284FWM1	4,330	1
			42	1	AMW421284FWM1	5,270	1
			48	1	AMW481284FWM1	5,360	1
			54	1	AMW541284FWM1	6,580	1
			60	1	AMW601284FWM1	6,670	1
			36	1	AMW361284FWM2	5,050	2
			42	1	AMW421284FWM2	6,170	2
			48	1	AMW481284FWM2	6,260	2
			54	1	AMW541284FWM2	7,670	2
			60	1	AMW601284FWM2	7,760	2

Please specify a back option:

SOLID BACK  
model number **OMWSOBK** - \$0 list

BACK WITH GROMMETS UPPER/LOWER  
model number **OMWGR2BK** - \$70 list

BACK WITH CUTOUT  
model number **OMWCO1BK** - \$60 list

STANDARD GROMMETS 2.38" GROMMET COVERS PROVIDED

75 PANEL THICKNESS

12.00

2.00

4.00

BRACES SUPPORT THE BASE OF THE MEDIA WALL PLACEMENT BASED ON WALL SIZE

ADJUSTABLE LEVELERS FOR WALL LEVELING (x6)

POST LAMINATED ENDS















10.42x12.42 ACCESS DOOR

FINGER PULL

HEAVY DUTY L BRACKETS SUPPLIED FOR ATTACHING THE WORK SURFACE TO THE MEDIA WALL

# bases

metal single base to use at the other end of a table with a under table media base or media wall









base	27.75"H	base dim.	qty	top depth	max top length when used with media wall	single base model no.	list	finish
Keller single column T		26 x 27.75H	1	36	72	BTKEL36000SDGME	480	standard metal
		33 x 27.75H	1	42	72	BTKEL42000SDGME	570	standard metal
		38 x 27.75H	1	48	72	BTKEL48000SDGME	640	standard metal
Keller single column T		26 x 27.75H	1	36	72	BTKEL36000SDGPO	570	polished
		33 x 27.75H	1	42	72	BTKEL42000SDGPO	660	polished
		38 x 27.75H	1	48	72	BTKEL48000SDGPO	750	polished
custom higher height (specify height)		26	1	36	72	BTKEL36000SHGME	550	standard metal
		33	1	42	72	BTKEL42000SHGME	640	standard metal
		38	1	48	72	BTKEL48000SHGME	710	standard metal
Keller double column T		26 x 27.75H	1	36	72	BTKEL36000SHGPO	660	polished
		33	1	42	72	BTKEL42000SHGPO	750	polished
		38	1	48	72	BTKEL48000SHGPO	830	polished
Keller double column T		34 x 27.75H	1	48	72	BTKEL480002DGME	590	standard metal
		40 x 27.75H	1	60	72	BTKEL600002DGME	640	standard metal
		34 x 27.75H	1	48	72	BTKEL480002DGPO	790	polished
custom higher height (specify height)		40 x 27.75H	1	60	72	BTKEL600002DGPO	850	polished
		34	1	48	72	BTKEL480002HGME	730	standard metal
		40	1	60	72	BTKEL600002HGME	780	standard metal
Ria single column T		34	1	48	72	BTKEL480002HGPO	970	polished
		40	1	60	72	BTKEL600002HGPO	1,020	polished
		26 x 27.75H	1	36	72	BTRIA36000SDGME	350	standard metal
Ria single column T		33 x 27.75H	1	42	72	BTRIA42000SDGME	370	standard metal
		38 x 27.75H	1	48	72	BTRIA48000SDGME	410	standard metal
		26 x 27.75H	1	36	72	BTRIA36000SDGPO	450	polished
custom higher height (specify height)		33 x 27.75H	1	42	72	BTRIA42000SDGPO	460	polished
		38 x 27.75H	1	48	72	BTRIA48000SDGPO	510	polished
		26	1	36	72	BTRIA36000SHGME	420	standard metal
Ria double column T		33	1	42	72	BTRIA42000SHGME	430	standard metal
		38	1	48	72	BTRIA48000SHGME	480	standard metal
		26	1	36	72	BTRIA36000SHGPO	530	polished
Ria double column T		33	1	42	72	BTRIA42000SHGPO	550	polished
		38	1	48	72	BTRIA48000SHGPO	600	polished
		34 x 27.75H	1	48	72	BTRIA480002DGME	550	standard metal
custom higher height (specify height)		40 x 27.75H	1	60	72	BTRIA600002DGME	600	standard metal
		34 x 27.75H	1	48	72	BTRIA480002DGPO	760	polished
		40 x 27.75H	1	60	72	BTRIA600002DGPO	800	polished
Ria double column T		34	1	48	72	BTRIA480002HGME	690	standard metal
		40	1	60	72	BTRIA600002HGME	730	standard metal
		34	1	48	72	BTRIA480002HGPO	930	polished
Ria double column T		40	1	60	72	BTRIA600002HGPO	970	polished

**(ME) Standard metal powder coat finishes :**  
Flat Black (FB), Furniture White (FW), Inner Tone (IT), Light Tone (LT), Medium Tone (MT), Metallic Silver (MS).

**(PO) polished aluminum / chrome finish option (Ria or Keller)**

# bases

metal single base to use at the other end of a table with a under table media base or media wall

base	base dim.	qty	top depth	max top length when used with media wall	single base model no.	list	finish		
Bassa rectangular frame		solid metal panel	18 x 6 x 27.75	1	36	72	BFBAS36000REGSM	1,980	standard metal
		perforated metal panel	24 x 6 x 27.75	1	48	72	BFBAS48000REGSM	2,050	standard metal
			34 x 6 x 27.75	1	60	72	BFBAS60000REGSM	2,180	standard metal
Bassa rectangular frame		perforated metal panel	18 x 6 x 27.75	1	36	72	BFBAS36000REGPM	2,020	standard metal
			24 x 6 x 27.75	1	48	72	BFBAS48000REGPM	2,070	standard metal
		34 x 6 x 27.75	1	60	72	BFBAS60000REGPM	2,310	standard metal	
Bassa curved frame		solid metal panel	20 x 6 x 27.75	1	36	72	BFBAS36000CUGSM	1,980	standard metal
		perforated metal panel	26 x 6 x 27.75	1	48	72	BFBAS48000CUGSM	2,040	standard metal
			36 x 6 x 27.75	1	60	72	BFBAS60000CUGSM	2,260	standard metal
Bassa curved frame		perforated metal panel	20 x 6 x 27.75	1	36	72	BFBAS36000CUGPM	2,010	standard metal
			26 x 6 x 27.75	1	48	72	BFBAS48000CUGPM	2,060	standard metal
		36 x 6 x 27.75	1	60	72	BFBAS60000CUGPM	2,260	standard metal	
Moto 3" single column T		27.75"H	26 x 27.75H	1	36	72	BTMOT36000SDGME	450	standard metal
		custom higher height (specify height)	26	1	36	72	BTMOT36000SHGME	530	standard metal
Moto 3" double column T		27.75"H	26 x 27.75H	1	36	72	BTMOT360002DGME	630	standard metal
		custom higher height (specify height)	32 x 27.75H	1	42	72	BTMOT420002DGME	660	standard metal
			36 x 27.75H	1	48	72	BTMOT480002DGME	720	standard metal
Moto 3" double column T		custom higher height (specify height)	26	1	36	72	BTMOT360002HGME	780	standard metal
			32	1	42	72	BTMOT420002HGME	810	standard metal
		36	1	48	72	BTMOT480002HGME	870	standard metal	
Zoey single column T		27.75"H	27 x 27.75H	1	36	72	BTZOE36000SDGME	320	standard metal
		33 x 27.75H	1	42	72	BTZOE42000SDGME	340	standard metal	
Zoey double column T		27.75"H	38 x 27.75H	1	48	72	BTZOE480002DGME	650	standard metal
		47 x 27.75H	1	60	72	BTZOE600002DGME	720	standard metal	



**(ME) Standard metal powder coat finishes :**  
Flat Black (FB), Furniture White (FW), Inner Tone (IT), Light Tone (LT), Medium Tone (MT), Metallic Silver (MS).

\* Laminate panels are available for Bassa, email service@symphonytables.com for pricing.

# bases

single laminate conference or media base

Lastra

base	base dim. W x D x H	qty	top depth	max top length when used with media wall	single base model no.	list	laminate grade	
Lastra 6" rectangle 	27.75"H	18 x 6 x 27.75	1	42	72	BLLAR4206D1GL1	790	1
		24 x 6 x 27.75	1	48	72	BLLAR4806D1GL1	900	1
		30 x 6 x 27.75	1	60	72	BLLAR6006D1GL1	1,060	1
		18 x 6 x 27.75	1	42	72	BLLAR4206D1GL2	910	2
		24 x 6 x 27.75	1	48	72	BLLAR4806D1GL2	1,050	2
		30 x 6 x 27.75	1	60	72	BLLAR6006D1GL2	1,230	2
	40.75"H	18 x 6 x 40.75	1	42	72	BLLAR4206H1GL1	960	1
		24 x 6 x 40.75	1	48	72	BLLAR4806H1GL1	1,100	1
		30 x 6 x 40.75	1	60	72	BLLAR6006H1GL1	1,220	1
		18 x 6 x 40.75	1	42	72	BLLAR4206H1GL2	1,130	2
		24 x 6 x 40.75	1	48	72	BLLAR4806H1GL2	1,220	2
		30 x 6 x 40.75	1	60	72	BLLAR6006H1GL2	1,420	2
Lastra 12" rectangle	27.75"H	18 x 12 x 27.75	1	42	84	BLLAR4212D1GL1	960	1
		24 x 12 x 27.75	1	48	84	BLLAR4812D1GL1	1,070	1
		30 x 12 x 27.75	1	60	84	BLLAR6012D1GL1	1,240	1
		18 x 12 x 27.75	1	42	84	BLLAR4212D1GL2	1,120	2
		24 x 12 x 27.75	1	48	84	BLLAR4812D1GL2	1,260	2
		30 x 12 x 27.75	1	60	84	BLLAR6012D1GL2	1,450	2
	40.75"H	18 x 12 x 40.75	1	42	84	BLLAR4212H1GL1	1,130	1
		24 x 12 x 40.75	1	48	84	BLLAR4812H1GL1	1,330	1
		30 x 12 x 40.75	1	60	84	BLLAR6012H1GL1	1,690	1
		18 x 12 x 40.75	1	42	84	BLLAR4212H1GL2	1,330	2
		24 x 12 x 40.75	1	48	84	BLLAR4812H1GL2	1,570	2
		30 x 12 x 40.75	1	60	84	BLLAR6012H1GL2	2,010	2
Lastra square 	27.75"H	18 x 18 x 27.75	1	36	84	BLLAS36036D1GL1	1,160	1
		20 x 20 x 27.75	1	42	84	BLLAS42042D1GL1	1,180	1
		24 x 24 x 27.75	1	48	90	BLLAS48048D1GL1	1,210	1
		30 x 30 x 27.75	1	54	96	BLLAS54054D1GL1	1,410	1
		36 x 36 x 27.75	1	60	102	BLLAS60060D1GL1	1,600	1
		18 x 18 x 27.75	1	36	72	BLLAS36036D1GL2	1,350	2
	40.75"H	20 x 20 x 40.75	1	36	72	BLLAS36036H1GL1	1,300	1
		24 x 24 x 40.75	1	42	78	BLLAS42042H1GL1	1,320	1
		30 x 30 x 40.75	1	48	84	BLLAS48048H1GL1	1,640	1
		36 x 36 x 40.75	1	54	90	BLLAS54054H1GL1	1,930	1
		18 x 18 x 40.75	1	30	72	BLLAS30030H1GL1	1,260	1
		20 x 20 x 40.75	1	36	72	BLLAS36036H1GL1	1,300	1
	40.75"H	24 x 24 x 40.75	1	42	78	BLLAS42042H1GL1	1,320	1
		30 x 30 x 40.75	1	48	84	BLLAS48048H1GL1	1,640	1
		36 x 36 x 40.75	1	54	90	BLLAS54054H1GL1	1,930	1
		18 x 18 x 40.75	1	30	72	BLLAS30030H1GL2	1,490	2
		20 x 20 x 40.75	1	36	72	BLLAS36036H1GL2	1,520	2
		24 x 24 x 40.75	1	42	78	BLLAS42042H1GL2	1,540	2
40.75"H	30 x 30 x 40.75	1	48	84	BLLAS48048H1GL2	1,930	2	
	36 x 36 x 40.75	1	54	90	BLLAS54054H1GL2	2,270	2	

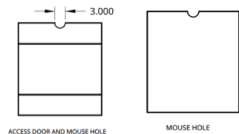

**Lastra hinged access door option:**

14.75"H hinged access door (1) for a seated height base, model # **OBLASDH129** - \$190 list each  
 15.75"H hinged access door (1) for a standing height base, model # **OBLASDH142** - \$210 list each

Lastra wire management mouse holes come on BOTH SIDES at the top / center of all bases in the set unless the base is specified with no wire management mouse holes, please indicate that you do not want mouse holes on one or both sides of the base in **bold face ALL CAPS** on your PO.

\* Lastra rectangle and square interior base dimensions are 1.5" less than the "W x D" dimension listed for each base  
 \*\* the bottom of the Lastra base is open to the floor

# bases

single laminate conference or media base

Tambo

T base	base dim. W x D x H	qty	top depth	max top length when used with media wall	single base model no.	list	laminate grade	
Tambo cylinder 	27.75"H	18 dia. x 27.75	1	36	84	BLTAM36036D1GL1	1,130	1
		20 dia. x 27.75	1	42	84	BLTAM42042D1GL1	1,340	1
		24 dia. x 27.75	1	48	90	BLTAM48048D1GL1	1,470	1
		30 dia. x 27.75	1	54	96	BLTAM54054D1GL1	1,750	1
		36 dia. x 27.75	1	60	102	BLTAM60060D1GL1	2,330	1
		18 dia. x 27.75	1	36	84	BLTAM36036D1GL2	1,220	2
	40.75"H	20 dia. x 27.75	1	42	84	BLTAM42042D1GL2	1,460	2
		24 dia. x 27.75	1	48	90	BLTAM48048D1GL2	1,620	2
		30 dia. x 27.75	1	54	96	BLTAM54054D1GL2	1,910	2
		36 dia. x 27.75	1	60	102	BLTAM60060D1GL2	2,540	2
		18 dia. x 40.75	1	30	72	BLTAM30030H1GL1	1,330	1
		20 dia. x 40.75	1	36	72	BLTAM36036H1GL1	1,570	1
24 dia. x 40.75		1	42	78	BLTAM42042H1GL1	1,740	1	
30 dia. x 40.75		1	48	84	BLTAM48048H1GL1	2,060	1	
36 dia. x 40.75		1	54	90	BLTAM54054H1GL1	2,730	1	
18 dia. x 40.75		1	30	72	BLTAM30030H1GL2	1,450	2	
20 dia. x 40.75		1	36	72	BLTAM36036H1GL2	1,730	2	
24 dia. x 40.75		1	42	78	BLTAM42042H1GL2	1,900	2	
30 dia. x 40.75	1	48	84	BLTAM48048H1GL2	2,240	2		
36 dia. x 40.75	1	54	90	BLTAM54054H1GL2	2,980	2		

**Tambo laminate base options:**





10 x 10 side hinged curved access door for a cylinder base, model # **OBLTAMWMD** - \$830 list per door  
 50 LB ballast bag (14x24x3H plastic rip stop material bag filled with small pebbles/stones), model # **OBLTAMBAL** - \$230 list per bag

\* Tambo cylinder bases have 4 metal top plates to mount the base to the top, there is a 10.5" hole centered at the top of the base and a 9.5" hole centered at the bottom of the base. Tambo bases do not come with wire management mouse holes.

# bases

media, fixed and flip nest V

Keller

base	base dim.	max top support	base qty	base set model no.	list	glide/caster	finish	
<b>Keller media base with perforated metal panels</b>								
	27.75"H	51 x 51	48 x 60, 54 sq, 60 rd	1	BMKEL540544DGME	2,810	adj glides	standard metal
		56 x 56	60 x 72, 60 sq, 72 rd	1	BMKEL600604DGME	2,850	adj glides	standard metal
	40.75"H	51 x 51	48 x 60, 54 sq, 60 rd	1	BMKEL540544BGME	3,360	adj glides	standard metal
		56 x 56	60 x 72, 60 sq, 72 rd	1	BMKEL600604BGME	3,390	adj glides	standard metal
<b>Keller fixed V base set (no stretcher)</b>								
	27.75"H	17.5	24 x 60	2	BVKEL24060SDGME	730	adj glides	standard metal
		23	30 x 60	2	BVKEL30060SDGME	760	adj glides	standard metal
		17.5	24 x 60	2	BVKEL24060SDCME	810	2" black hard casters	standard metal
		23	30 x 60	2	BVKEL30060SDCME	840	2" black hard casters	standard metal
		17.5	24 x 60	2	BVKEL24060SDSME	850	2" black soft casters	standard metal
		23	30 x 60	2	BVKEL30060SDSME	880	2" black soft casters	standard metal
		17.5	24 x 60	2	BVKEL24060SDGPO	940	adj glides	polished
		23	30 x 60	2	BVKEL30060SDGPO	980	adj glides	polished
		17.5	24 x 60	2	BVKEL24060SDCPO	1,020	2" black hard casters	polished
		23	30 x 60	2	BVKEL30060SDCPO	1,060	2" black hard casters	polished
		17.5	24 x 60	2	BVKEL24060SDSPO	1,060	2" black soft casters	polished
		23	30 x 60	2	BVKEL30060SDSPO	1,100	2" black soft casters	polished
<b>Keller flip nest V base set (no stretcher)</b>								
	27.75"H	17.5	24 x 60	2	BVKEL24060NEGME	1,170	adj glides	standard metal
		23	30 x 60	2	BVKEL30060NEGME	1,230	adj glides	standard metal
		17.5	24 x 60	2	BVKEL24060NECME	1,250	2" black hard casters	standard metal
		23	30 x 60	2	BVKEL30060NECME	1,310	2" black hard casters	standard metal
		17.5	24 x 60	2	BVKEL24060NESME	1,290	2" black soft casters	standard metal
		23	30 x 60	2	BVKEL30060NESME	1,350	2" black soft casters	standard metal
		17.5	24 x 60	2	BVKEL24060NEGPO	1,390	adj glides	polished
		23	30 x 60	2	BVKEL30060NEGPO	1,450	adj glides	polished
		17.5	24 x 60	2	BVKEL24060NECPO	1,470	2" black hard casters	polished
		23	30 x 60	2	BVKEL30060NECPO	1,530	2" black hard casters	polished
		17.5	24 x 60	2	BVKEL24060NESPO	1,510	2" black soft casters	polished
		23	30 x 60	2	BVKEL30060NESPO	1,570	2" black soft casters	polished



**C casters**  
2" black dual wheel locking hard casters (for carpet)

**S casters**  
2" black dual wheel locking soft casters (for hard floors)

**Standard metal powder coat finishes (ME)**  
Black Wrinkle, Chateau Brown Wrinkle, Flat Black, Furniture White, Inner Tone, Light Tone, Medium Tone and Metallic Silver

**Premium Polished Finishes (PO)**  
polished aluminum/steel  
\*polished finish is not available for Keller or Ria Media bases with perforated metal panels

The Keller & Ria Media bases feature a 10.5 x 10.5" enclosure with the perforated metal panels.

### Media Table Wall Support Bracket

Shall be used in peninsula applications for top sizes up to 48 x 60 for the 51 x 51 base or tops up to 60 x 72 with the 56 x 56 inch Ria or Keller Media base. Wall bracket must be secured to the wall studs with 5/16 diameter screws, dealer/installer shall provide the hardware.  
Finish is Furniture White





Use the 33-7/8" long bracket for tops that are 42" - 48" where the top connects to the wall, model #OBMWB48, \$350 list each

Use the 50" long bracket for tops that are 54" - 60" where the top connects to the wall, model #OBMWB60, \$450 list each

# bases

media, fixed and flip nest V

Ria

base	base dim.	max top support	base qty	base set model no.	list	glide/caster	finish	
<b>Ria media base with perforated metal panels</b>								
	27.75"H	51 x 51	48 x 60, 54 sq, 60 rd	1	BMRIA540544DGME	2,770	adj glides	standard metal
		56 x 56	60 x 72, 60 sq, 72 rd	1	BMRIA600604DGME	2,810	adj glides	standard metal
	40.75"H	51 x 51	48 x 60, 54 sq, 60 rd	1	BMRIA540544BGME	3,320	adj glides	standard metal
		56 x 56	60 x 72, 60 sq, 72 rd	1	BMRIA600604BGME	3,360	adj glides	standard metal
<b>Ria fixed V base set (no stretcher)</b>								
	27.75"H	17.5	24 x 60	2	BVRIA24060SDGME	690	adj glides	standard metal
		23	30 x 60	2	BVRIA30060SDGME	730	adj glides	standard metal
		17.5	24 x 60	2	BVRIA24060SDCME	770	2" black hard casters	standard metal
		23	30 x 60	2	BVRIA30060SDCME	810	2" black hard casters	standard metal
		17.5	24 x 60	2	BVRIA24060SDSME	810	2" black soft casters	standard metal
		23	30 x 60	2	BVRIA30060SDSME	850	2" black soft casters	standard metal
		17.5	24 x 60	2	BVRIA24060SDGPO	910	adj glides	polished
		23	30 x 60	2	BVRIA30060SDGPO	940	adj glides	polished
		17.5	24 x 60	2	BVRIA24060SDCPO	990	2" black hard casters	polished
		23	30 x 60	2	BVRIA30060SDCPO	1,020	2" black hard casters	polished
		17.5	24 x 60	2	BVRIA24060SDSPO	1,030	2" black soft casters	polished
		23	30 x 60	2	BVRIA30060SDSPO	1,060	2" black soft casters	polished
<b>Ria flip nest V base set (no stretcher)</b>								
	27.75"H	17.5	24 x 60	2	BVRIA24060NEGME	1,140	adj glides	standard metal
		23	30 x 60	2	BVRIA30060NEGME	1,200	adj glides	standard metal
		17.5	24 x 60	2	BVRIA24060NECME	1,220	2" black hard casters	standard metal
		23	30 x 60	2	BVRIA30060NECME	1,280	2" black hard casters	standard metal
		17.5	24 x 60	2	BVRIA24060NESME	1,260	2" black soft casters	standard metal
		23	30 x 60	2	BVRIA30060NESME	1,320	2" black soft casters	standard metal
		17.5	24 x 60	2	BVRIA24060NEGPO	1,340	adj glides	polished
		23	30 x 60	2	BVRIA30060NEGPO	1,390	adj glides	polished
		17.5	24 x 60	2	BVRIA24060NECPO	1,420	2" black hard casters	polished
		23	30 x 60	2	BVRIA30060NECPO	1,470	2" black hard casters	polished
		17.5	24 x 60	2	BVRIA24060NESPO	1,460	2" black soft casters	polished
		23	30 x 60	2	BVRIA30060NESPO	1,510	2" black soft casters	polished



**C casters**  
2" black dual wheel locking hard casters (for carpet)

**S casters**  
2" black dual wheel locking soft casters (for hard floors)

**Standard metal powder coat finishes (ME)**  
Black Wrinkle, Chateau Brown Wrinkle, Flat Black, Furniture White, Inner Tone, Light Tone, Medium Tone and Metallic Silver

**Premium Polished Finishes (PO)**  
polished aluminum/steel  
\*polished finish is not available for Keller or Ria Media bases with perforated metal panels

The Keller & Ria Media bases feature a 10.5 x 10.5" enclosure with the perforated metal panels.

### Media Table Wall Support Bracket

Shall be used in peninsula applications for top sizes up to 48 x 60 for the 51 x 51 base or tops up to 60 x 72 with the 56 x 56 inch Ria or Keller Media base. Wall bracket must be secured to the wall studs with 5/16 diameter screws, dealer/installer shall provide the hardware.  
Finish is Furniture White

Use the 33-7/8" long bracket for tops that are 42" - 48" where the top connects to the wall, model #OBMWB48, \$350 list each

Use the 50" long bracket for tops that are 54" - 60" where the top connects to the wall, model #OBMWB60, \$450 list each



# bases

## Keller Y with stretcher

For complete model number:

1. Insert height selection :

D dining height 27.75"H- see below chart for pricing

H custom higher height (specify height) - see below chart for pricing

L custom lower height (specify height) - see below chart for pricing

base	base qty + dim.	stretcher	max top support	base set model no.	<u>D</u> dining height list	<u>H</u> custom taller ht or <u>L</u> custom lower ht	glides or casters	finish
Keller Y with stretcher for use with a rectangular top								
	(2) 17.5	(1) 40	24 x 60	BYKEL224060S	G ME	1,030	1,210	adj glides standard metal
	(2) 23	(1) 40	30 x 60	BYKEL230060S	G ME	1,070	1,250	adj glides standard metal
	(2) 29	(1) 34	36 x 60	BYKEL236060S	G ME	1,230	1,410	adj glides standard metal
	(2) 33.5	(1) 34	48 x 60	BYKEL248060S	G ME	1,380	1,560	adj glides standard metal
	(2) 17.5	(1) 50	24 x 72	BYKEL224072S	G ME	1,080	1,260	adj glides standard metal
	(2) 23	(1) 50	30 x 72	BYKEL230072S	G ME	1,110	1,290	adj glides standard metal
	(2) 29	(1) 40	36 x 72	BYKEL236072S	G ME	1,240	1,420	adj glides standard metal
	(2) 33.5	(1) 40	48 x 72	BYKEL248072S	G ME	1,390	1,570	adj glides standard metal
	(2) 29	(1) 50	36 x 84	BYKEL236084S	G ME	1,310	1,490	adj glides standard metal
	(2) 33.5	(1) 50	48 x 84	BYKEL248084S	G ME	1,460	1,640	adj glides standard metal
	(2) 29	(1) 58	36 x 96	BYKEL236096S	G ME	1,340	1,520	adj glides standard metal
	(2) 33.5	(1) 58	48 x 96	BYKEL248096S	G ME	1,490	1,670	adj glides standard metal
	(2) 17.5	(1) 40	24 x 60	BYKEL224060S	C ME	1,110	1,290	2" black hard casters standard metal
	(2) 23	(1) 40	30 x 60	BYKEL230060S	C ME	1,150	1,330	2" black hard casters standard metal
	(2) 29	(1) 34	36 x 60	BYKEL236060S	C ME	1,310	1,490	2" black hard casters standard metal
	(2) 33.5	(1) 34	48 x 60	BYKEL248060S	C ME	1,460	1,640	2" black hard casters standard metal
	(2) 17.5	(1) 50	24 x 72	BYKEL224072S	C ME	1,160	1,340	2" black hard casters standard metal
	(2) 23	(1) 50	30 x 72	BYKEL230072S	C ME	1,190	1,370	2" black hard casters standard metal
	(2) 29	(1) 40	36 x 72	BYKEL236072S	C ME	1,320	1,500	2" black hard casters standard metal
	(2) 33.5	(1) 40	48 x 72	BYKEL248072S	C ME	1,470	1,650	2" black hard casters standard metal
	(2) 29	(1) 50	36 x 84	BYKEL236084S	C ME	1,390	1,570	2" black hard casters standard metal
	(2) 33.5	(1) 50	48 x 84	BYKEL248084S	C ME	1,540	1,720	2" black hard casters standard metal
	(2) 29	(1) 58	36 x 96	BYKEL236096S	C ME	1,420	1,600	2" black hard casters standard metal
	(2) 33.5	(1) 58	48 x 96	BYKEL248096S	C ME	1,570	1,750	2" black hard casters standard metal
	(2) 17.5	(1) 40	24 x 60	BYKEL224060S	S ME	1,150	1,330	2" black soft casters standard metal
	(2) 23	(1) 40	30 x 60	BYKEL230060S	S ME	1,190	1,370	2" black soft casters standard metal
	(2) 29	(1) 34	36 x 60	BYKEL236060S	S ME	1,350	1,530	2" black soft casters standard metal
	(2) 33.5	(1) 34	48 x 60	BYKEL248060S	S ME	1,500	1,680	2" black soft casters standard metal
	(2) 17.5	(1) 50	24 x 72	BYKEL224072S	S ME	1,200	1,380	2" black soft casters standard metal
	(2) 23	(1) 50	30 x 72	BYKEL230072S	S ME	1,230	1,410	2" black soft casters standard metal
	(2) 29	(1) 40	36 x 72	BYKEL236072S	S ME	1,360	1,540	2" black soft casters standard metal
	(2) 33.5	(1) 40	48 x 72	BYKEL248072S	S ME	1,510	1,690	2" black soft casters standard metal
	(2) 29	(1) 50	36 x 84	BYKEL236084S	S ME	1,430	1,610	2" black soft casters standard metal
	(2) 33.5	(1) 50	48 x 84	BYKEL248084S	S ME	1,580	1,760	2" black soft casters standard metal
	(2) 29	(1) 58	36 x 96	BYKEL236096S	S ME	1,460	1,640	2" black soft casters standard metal
	(2) 33.5	(1) 58	48 x 96	BYKEL248096S	S ME	1,610	1,790	2" black soft casters standard metal
Keller Y with stretcher for use with a boat, half arced rectangle, half boat, bullet or racetrack top								
	(2) 33.5	(1) 34	48 x 72	BYKEL348072S	G ME	1,380	1,560	adj glides standard metal
	(2) 33.5	(1) 40	48 x 84	BYKEL348084S	G ME	1,390	1,570	adj glides standard metal
	(2) 33.5	(1) 50	48 x 96	BYKEL348096S	G ME	1,460	1,640	adj glides standard metal
	(2) 33.5	(1) 34	48 x 72	BYKEL348072S	C ME	1,460	1,640	2" black hard casters standard metal
	(2) 33.5	(1) 40	48 x 84	BYKEL348084S	C ME	1,470	1,650	2" black hard casters standard metal
	(2) 33.5	(1) 50	48 x 96	BYKEL348096S	C ME	1,540	1,720	2" black hard casters standard metal
	(2) 33.5	(1) 34	48 x 72	BYKEL348072S	S ME	1,500	1,680	2" black soft casters standard metal
	(2) 33.5	(1) 40	48 x 84	BYKEL348084S	S ME	1,510	1,690	2" black soft casters standard metal
	(2) 33.5	(1) 50	48 x 96	BYKEL348096S	S ME	1,580	1,760	2" black soft casters standard metal
Keller Y with stretcher for use with an oval top								
	(2) 33.5	(1) 34	48 x 84	BYKEL448084S	G ME	1,380	1,560	adj glides standard metal
	(2) 33.5	(1) 40	48 x 96	BYKEL448096S	G ME	1,390	1,570	adj glides standard metal
	(2) 33.5	(1) 34	48 x 84	BYKEL448084S	C ME	1,460	1,640	2" black hard casters standard metal
	(2) 33.5	(1) 40	48 x 96	BYKEL448096S	C ME	1,470	1,650	2" black hard casters standard metal
	(2) 33.5	(1) 34	48 x 84	BYKEL448084S	S ME	1,500	1,680	2" black soft casters standard metal
	(2) 33.5	(1) 40	48 x 96	BYKEL448096S	S ME	1,510	1,690	2" black soft casters standard metal

**C casters**

2" black dual wheel locking hard casters (for carpet)

**Standard metal powder coat finishes (ME)**

Black Wrinkle, Chateau Brown Wrinkle, Flat Black, Furniture White, Inner Tone, Light Tone, Medium Tone and Metallic Silver

**S casters**

2" black dual wheel locking soft casters (for hard floors)

**Premium Polished Finishes (PO)**

polished aluminum/steel



# bases

## Keller Y base with stretcher

For complete model number:

1. Insert height selection :

D dining height 27.75"H- see below chart for pricing

H custom higher height (specify height) - see below chart for pricing

L custom lower height (specify height) - see below chart for pricing

base	base qty + dim.	stretcher	max top support	base set model no.	<u>D</u> dining height list	<u>H</u> custom taller ht or <u>L</u> custom lower ht	glides or casters	finish
Keller Y with stretcher for use with a rectangular top								
	(2) 17.5	(1) 40	24 x 60	BYKEL224060S	G PO	1,350	1,530	adj glides polished
	(2) 23	(1) 40	30 x 60	BYKEL230060S	G PO	1,380	1,560	adj glides polished
	(2) 29	(1) 34	36 x 60	BYKEL236060S	G PO	1,540	1,720	adj glides polished
	(2) 33.5	(1) 34	48 x 60	BYKEL248060S	G PO	1,690	1,870	adj glides polished
	(2) 17.5	(1) 50	24 x 72	BYKEL224072S	G PO	1,400	1,580	adj glides polished
	(2) 23	(1) 50	30 x 72	BYKEL230072S	G PO	1,430	1,610	adj glides polished
	(2) 29	(1) 40	36 x 72	BYKEL236072S	G PO	1,560	1,740	adj glides polished
	(2) 33.5	(1) 40	48 x 72	BYKEL248072S	G PO	1,710	1,890	adj glides polished
	(2) 29	(1) 50	36 x 84	BYKEL236084S	G PO	1,630	1,810	adj glides polished
	(2) 33.5	(1) 50	48 x 84	BYKEL248084S	G PO	1,780	1,960	adj glides polished
	(2) 29	(1) 58	36 x 96	BYKEL236096S	G PO	1,670	1,850	adj glides polished
	(2) 33.5	(1) 58	48 x 96	BYKEL248096S	G PO	1,820	2,000	adj glides polished
	(2) 17.5	(1) 40	24 x 60	BYKEL224060S	C PO	1,430	1,610	2" black hard casters polished
	(2) 23	(1) 40	30 x 60	BYKEL230060S	C PO	1,460	1,640	2" black hard casters polished
	(2) 29	(1) 34	36 x 60	BYKEL236060S	C PO	1,620	1,800	2" black hard casters polished
	(2) 33.5	(1) 34	48 x 60	BYKEL248060S	C PO	1,770	1,950	2" black hard casters polished
	(2) 17.5	(1) 50	24 x 72	BYKEL224072S	C PO	1,480	1,660	2" black hard casters polished
	(2) 23	(1) 50	30 x 72	BYKEL230072S	C PO	1,510	1,690	2" black hard casters polished
	(2) 29	(1) 40	36 x 72	BYKEL236072S	C PO	1,640	1,820	2" black hard casters polished
	(2) 33.5	(1) 40	48 x 72	BYKEL248072S	C PO	1,790	1,970	2" black hard casters polished
	(2) 29	(1) 50	36 x 84	BYKEL236084S	C PO	1,710	1,890	2" black hard casters polished
	(2) 33.5	(1) 50	48 x 84	BYKEL248084S	C PO	1,860	2,040	2" black hard casters polished
	(2) 29	(1) 58	36 x 96	BYKEL236096S	C PO	1,750	1,930	2" black hard casters polished
	(2) 33.5	(1) 58	48 x 96	BYKEL248096S	C PO	1,900	2,080	2" black hard casters polished
	(2) 17.5	(1) 40	24 x 60	BYKEL224060S	S PO	1,470	1,650	2" black soft casters polished
	(2) 23	(1) 40	30 x 60	BYKEL230060S	S PO	1,500	1,680	2" black soft casters polished
	(2) 29	(1) 34	36 x 60	BYKEL236060S	S PO	1,660	1,840	2" black soft casters polished
	(2) 33.5	(1) 34	48 x 60	BYKEL248060S	S PO	1,810	1,990	2" black soft casters polished
	(2) 17.5	(1) 50	24 x 72	BYKEL224072S	S PO	1,520	1,700	2" black soft casters polished
	(2) 23	(1) 50	30 x 72	BYKEL230072S	S PO	1,550	1,730	2" black soft casters polished
	(2) 29	(1) 40	36 x 72	BYKEL236072S	S PO	1,680	1,860	2" black soft casters polished
	(2) 33.5	(1) 40	48 x 72	BYKEL248072S	S PO	1,830	2,010	2" black soft casters polished
	(2) 29	(1) 50	36 x 84	BYKEL236084S	S PO	1,750	1,930	2" black soft casters polished
	(2) 33.5	(1) 50	48 x 84	BYKEL248084S	S PO	1,900	2,080	2" black soft casters polished
	(2) 29	(1) 58	36 x 96	BYKEL236096S	S PO	1,790	1,970	2" black soft casters polished
	(2) 33.5	(1) 58	48 x 96	BYKEL248096S	S PO	1,940	2,120	2" black soft casters polished
Keller Y with stretcher for use with a boat, half boat, bullet or racetrack top								
	(2) 33.5	(1) 34	48 x 72	BYKEL348072S	G PO	1,690	1,870	adj glides polished
	(2) 33.5	(1) 40	48 x 84	BYKEL348084S	G PO	1,730	1,910	adj glides polished
	(2) 33.5	(1) 50	48 x 96	BYKEL348096S	G PO	1,780	1,960	adj glides polished
	(2) 33.5	(1) 34	48 x 72	BYKEL348072S	C PO	1,770	1,950	2" black hard casters polished
	(2) 33.5	(1) 40	48 x 84	BYKEL348084S	C PO	1,810	1,990	2" black hard casters polished
	(2) 33.5	(1) 50	48 x 96	BYKEL348096S	C PO	1,860	2,040	2" black hard casters polished
	(2) 33.5	(1) 34	48 x 72	BYKEL348072S	S PO	1,810	1,990	2" black soft casters polished
	(2) 33.5	(1) 40	48 x 84	BYKEL348084S	S PO	1,850	2,030	2" black soft casters polished
	(2) 33.5	(1) 50	48 x 96	BYKEL348096S	S PO	1,900	2,080	2" black soft casters polished
Keller Y with stretcher for use with an oval top								
	(2) 33.5	(1) 34	48 x 84	BYKEL448084S	G PO	1,700	1,880	adj glides polished
	(2) 33.5	(1) 40	48 x 96	BYKEL448096S	G PO	1,770	1,950	adj glides polished
	(2) 33.5	(1) 34	48 x 84	BYKEL448084S	C PO	1,780	1,960	2" black hard casters polished
	(2) 33.5	(1) 40	48 x 96	BYKEL448096S	C PO	1,850	2,030	2" black hard casters polished
	(2) 33.5	(1) 34	48 x 84	BYKEL448084S	S PO	1,820	2,000	2" black soft casters polished
	(2) 33.5	(1) 40	48 x 96	BYKEL448096S	S PO	1,890	2,070	2" black soft casters polished

**C casters**

2" black dual wheel locking hard

# bases

## Keller YY bases with stretchers

For complete model number:

1. Insert height selection :

D dining height 27.75"H- see below chart for pricing

H custom higher height (specify height) - see below chart for pricing

L custom lower height (specify height) - see below chart for pricing

base	base qty + dim.	stretchers	max top support	base set model no.	<u>D</u> dining height list	<u>H</u> custom taller ht or <u>L</u> custom lower ht list	glides or casters	finish	
Keller YY with stretchers for use with a boat, bullet media, half arced rectangle, half boat, or rectangle top									
	(2) 32 YY	(2) 34	42-48 x 72	BYKEL548072S	G ME	2,020	2,320	adj glides	standard metal
	(2) 38 YY	(2) 34	54-60 x 72	BYKEL560072S	G ME	2,080	2,380	adj glides	standard metal
	(2) 32 YY	(2) 40	42-48 x 84	BYKEL548084S	G ME	2,050	2,350	adj glides	standard metal
	(2) 38 YY	(2) 40	54-60 x 84	BYKEL560084S	G ME	2,100	2,400	adj glides	standard metal
	(2) 32 YY	(2) 50	42-48 x 96	BYKEL548096S	G ME	2,130	2,430	adj glides	standard metal
	(2) 38 YY	(2) 50	54-60 x 96	BYKEL560096S	G ME	2,190	2,490	adj glides	standard metal
	(2) 32 YY	(2) 34	42-48 x 72	BYKEL548072S	C ME	2,100	2,400	2" black hard casters	standard metal
	(2) 38 YY	(2) 34	54-60 x 72	BYKEL560072S	C ME	2,160	2,460	2" black hard casters	standard metal
	(2) 32 YY	(2) 40	42-48 x 84	BYKEL548084S	C ME	2,130	2,430	2" black hard casters	standard metal
	(2) 38 YY	(2) 40	54-60 x 84	BYKEL560084S	C ME	2,180	2,480	2" black hard casters	standard metal
(2) 32 YY	(2) 50	42-48 x 96	BYKEL548096S	C ME	2,210	2,510	2" black hard casters	standard metal	
(2) 38 YY	(2) 50	54-60 x 96	BYKEL560096S	C ME	2,270	2,570	2" black hard casters	standard metal	
(2) 32 YY	(2) 34	42-48 x 72	BYKEL548072S	S ME	2,140	2,440	2" black soft casters	standard metal	
(2) 38 YY	(2) 34	54-60 x 72	BYKEL560072S	S ME	2,200	2,500	2" black soft casters	standard metal	
(2) 32 YY	(2) 40	42-48 x 84	BYKEL548084S	S ME	2,170	2,470	2" black soft casters	standard metal	
(2) 38 YY	(2) 40	54-60 x 84	BYKEL560084S	S ME	2,220	2,520	2" black soft casters	standard metal	
(2) 32 YY	(2) 50	42-48 x 96	BYKEL548096S	S ME	2,250	2,550	2" black soft casters	standard metal	
(2) 38 YY	(2) 50	54-60 x 96	BYKEL560096S	S ME	2,310	2,610	2" black soft casters	standard metal	
Keller YY with stretchers for use with a racetrack top									
(2) 32 YY	(2) 34	42-48 x 72	BYKEL648072S	G ME	2,020	2,320	adj glides	standard metal	
(2) 32 YY	(2) 40	42-48 x 84	BYKEL648084S	G ME	2,050	2,350	adj glides	standard metal	
(2) 38 YY	(2) 40	54-60 x 84	BYKEL660084S	G ME	2,100	2,400	adj glides	standard metal	
(2) 32 YY	(2) 50	42-48 x 96	BYKEL648096S	G ME	2,130	2,430	adj glides	standard metal	
(2) 38 YY	(2) 50	54-60 x 96	BYKEL660096S	G ME	2,190	2,490	adj glides	standard metal	
(2) 32 YY	(2) 34	42-48 x 72	BYKEL648072S	C ME	2,100	2,400	2" black hard casters	standard metal	
(2) 32 YY	(2) 40	42-48 x 84	BYKEL648084S	C ME	2,130	2,430	2" black hard casters	standard metal	
(2) 38 YY	(2) 40	54-60 x 84	BYKEL660084S	C ME	2,180	2,480	2" black hard casters	standard metal	
(2) 32 YY	(2) 50	42-48 x 96	BYKEL648096S	C ME	2,210	2,510	2" black hard casters	standard metal	
(2) 38 YY	(2) 50	54-60 x 96	BYKEL660096S	C ME	2,270	2,570	2" black hard casters	standard metal	
(2) 32 YY	(2) 34	42-48 x 72	BYKEL648072S	S ME	2,140	2,440	2" black soft casters	standard metal	
(2) 32 YY	(2) 40	42-48 x 84	BYKEL648084S	S ME	2,170	2,470	2" black soft casters	standard metal	
(2) 38 YY	(2) 40	54-60 x 84	BYKEL660084S	S ME	2,220	2,520	2" black soft casters	standard metal	
(2) 32 YY	(2) 50	42-48 x 96	BYKEL648096S	S ME	2,250	2,550	2" black soft casters	standard metal	
(2) 38 YY	(2) 50	54-60 x 96	BYKEL660096S	S ME	2,310	2,610	2" black soft casters	standard metal	
Keller YY with stretchers for use with an oval top									
(2) 32 YY	(2) 34	48 x 84	BYKEL748084S	G ME	2,020	2,320	adj glides	standard metal	
(2) 38 YY	(2) 34	54-60 x 84	BYKEL760084S	G ME	2,080	2,380	adj glides	standard metal	
(2) 32 YY	(2) 40	42-48 x 96	BYKEL748096S	G ME	2,050	2,350	adj glides	standard metal	
(2) 38 YY	(2) 40	54-60 x 96	BYKEL760096S	G ME	2,100	2,400	adj glides	standard metal	
(2) 32 YY	(2) 34	48 x 84	BYKEL748084S	C ME	2,100	2,400	2" black hard casters	standard metal	
(2) 38 YY	(2) 34	54-60 x 84	BYKEL760084S	C ME	2,160	2,460	2" black hard casters	standard metal	
(2) 32 YY	(2) 40	42-48 x 96	BYKEL748096S	C ME	2,130	2,430	2" black hard casters	standard metal	
(2) 38 YY	(2) 40	54-60 x 96	BYKEL760096S	C ME	2,180	2,480	2" black hard casters	standard metal	
(2) 32 YY	(2) 34	48 x 84	BYKEL748084S	S ME	2,140	2,440	2" black soft casters	standard metal	
(2) 38 YY	(2) 34	54-60 x 84	BYKEL760084S	S ME	2,200	2,500	2" black soft casters	standard metal	
(2) 32 YY	(2) 40	42-48 x 96	BYKEL748096S	S ME	2,170	2,470	2" black soft casters	standard metal	
(2) 38 YY	(2) 40	54-60 x 96	BYKEL760096S	S ME	2,220	2,520	2" black soft casters	standard metal	

Standard metal powder coat finishes (ME)

Black Wrinkle, Chateau Brown Wrinkle, Flat Black, Furniture White, Inner Tone, Light Tone, Medium Tone and Metallic Silver

Premium Polished Finishes (PO)

polished aluminum/steel

Note that the YY bases with 34 inch stretchers will not fit under a 54 x 72 or 60 x 72 racetrack top. Contact service@symphonytables.com for custom stretcher pricing.

The Keller YY bases with stretchers for the KEL5 category for boat, bullet media, half arced rectangle, half boat or rectangle tops will fit under trapezoid media tops with the exception of 42" deep tops with a 30" small end, increase the small end to 32 inches and the bases will fit. This is a non-standard top shape for us so please notate this clearly on your order.

# bases

## Keller YY bases with stretchers

For complete model number:

1. Insert height selection :

D dining height 27.75"H- see below chart for pricing

H custom higher height (specify height) - see below chart for pricing

L custom lower height (specify height) - see below chart for pricing

base	base qty + dim.	stretchers	max top support	base set model no.	<u>D</u> dining height list	<u>H</u> custom taller ht or <u>L</u> custom lower ht list	glides or casters	finish	
Keller YY with stretchers for use with a boat, bullet media, half arced rectangle, half boat, or rectangle top									
	(2) 32 YY	(2) 34	42-48 x 72	BYKEL548072S	G PO	2,450	2,800	adj glides	polished
	(2) 38 YY	(2) 34	54-60 x 72	BYKEL560072S	G PO	2,510	2,860	adj glides	polished
	(2) 32 YY	(2) 40	42-48 x 84	BYKEL548084S	G PO	2,480	2,830	adj glides	polished
	(2) 38 YY	(2) 40	54-60 x 84	BYKEL560084S	G PO	2,530	2,880	adj glides	polished
	(2) 32 YY	(2) 50	42-48 x 96	BYKEL548096S	G PO	2,560	2,910	adj glides	polished
	(2) 38 YY	(2) 50	54-60 x 96	BYKEL560096S	G PO	2,620	2,970	adj glides	polished
	(2) 32 YY	(2) 34	42-48 x 72	BYKEL548072S	C PO	2,530	2,880	2" black hard casters	polished
	(2) 38 YY	(2) 34	54-60 x 72	BYKEL560072S	C PO	2,590	2,940	2" black hard casters	polished
	(2) 32 YY	(2) 40	42-48 x 84	BYKEL548084S	C PO	2,560	2,910	2" black hard casters	polished
	(2) 38 YY	(2) 40	54-60 x 84	BYKEL560084S	C PO	2,610	2,960	2" black hard casters	polished
(2) 32 YY	(2) 50	42-48 x 96	BYKEL548096S	C PO	2,640	2,990	2" black hard casters	polished	
(2) 38 YY	(2) 50	54-60 x 96	BYKEL560096S	C PO	2,700	3,050	2" black hard casters	polished	
(2) 32 YY	(2) 34	42-48 x 72	BYKEL548072S	S PO	2,570	2,920	2" black soft casters	polished	
(2) 38 YY	(2) 34	54-60 x 72	BYKEL560072S	S PO	2,630	2,980	2" black soft casters	polished	
(2) 32 YY	(2) 40	42-48 x 84	BYKEL548084S	S PO	2,600	2,950	2" black soft casters	polished	
(2) 38 YY	(2) 40	54-60 x 84	BYKEL560084S	S PO	2,650	3,000	2" black soft casters	polished	
(2) 32 YY	(2) 50	42-48 x 96	BYKEL548096S	S PO	2,680	3,030	2" black soft casters	polished	
(2) 38 YY	(2) 50	54-60 x 96	BYKEL560096S	S PO	2,740	3,090	2" black soft casters	polished	
Keller YY with stretchers for use with a racetrack top									
(2) 32 YY	(2) 34	42-48 x 72	BYKEL648072S	G PO	2,450	2,800	adj glides	polished	
(2) 32 YY	(2) 40	42-48 x 84	BYKEL648084S	G PO	2,480	2,830	adj glides	polished	
(2) 38 YY	(2) 40	54-60 x 84	BYKEL660084S	G PO	2,530	2,880	adj glides	polished	
(2) 32 YY	(2) 50	42-48 x 96	BYKEL648096S	G PO	2,560	2,910	adj glides	polished	
(2) 38 YY	(2) 50	54-60 x 96	BYKEL660096S	G PO	2,620	2,970	adj glides	polished	
(2) 32 YY	(2) 34	42-48 x 72	BYKEL648072S	C PO	2,530	2,880	2" black hard casters	polished	
(2) 32 YY	(2) 40	42-48 x 84	BYKEL648084S	C PO	2,560	2,910	2" black hard casters	polished	
(2) 38 YY	(2) 40	54-60 x 84	BYKEL660084S	C PO	2,610	2,960	2" black hard casters	polished	
(2) 32 YY	(2) 50	42-48 x 96	BYKEL648096S	C PO	2,640	2,990	2" black hard casters	polished	
(2) 38 YY	(2) 50	54-60 x 96	BYKEL660096S	C PO	2,700	3,050	2" black hard casters	polished	
(2) 32 YY	(2) 34	42-48 x 72	BYKEL648072S	S PO	2,570	2,920	2" black soft casters	polished	
(2) 32 YY	(2) 40	42-48 x 84	BYKEL648084S	S PO	2,600	2,950	2" black soft casters	polished	
(2) 38 YY	(2) 40	54-60 x 84	BYKEL660084S	S PO	2,650	3,000	2" black soft casters	polished	
(2) 32 YY	(2) 50	42-48 x 96	BYKEL648096S	S PO	2,680	3,030	2" black soft casters	polished	
(2) 38 YY	(2) 50	54-60 x 96	BYKEL660096S	S PO	2,740	3,090	2" black soft casters	polished	
Keller YY with stretchers for use with an oval top									
(2) 32 YY	(2) 34	48 x 84	BYKEL748084S	G PO	2,450	2,800	adj glides	polished	
(2) 38 YY	(2) 34	54-60 x 84	BYKEL760084S	G PO	2,510	2,860	adj glides	polished	
(2) 32 YY	(2) 40	42-48 x 96	BYKEL748096S	G PO	2,480	2,830	adj glides	polished	
(2) 38 YY	(2) 40	54-60 x 96	BYKEL760096S	G PO	2,530	2,880	adj glides	polished	
(2) 32 YY	(2) 34	48 x 84	BYKEL748084S	C PO	2,530	2,880	2" black hard casters	polished	
(2) 38 YY	(2) 34	54-60 x 84	BYKEL760084S	C PO	2,590	2,940	2" black hard casters	polished	
(2) 32 YY	(2) 40	42-48 x 96	BYKEL748096S	C PO	2,560	2,910	2" black hard casters	polished	
(2) 38 YY	(2) 40	54-60 x 96	BYKEL760096S	C PO	2,610	2,960	2" black hard casters	polished	
(2) 32 YY	(2) 34	48 x 84	BYKEL748084S	S PO	2,570	2,920	2" black soft casters	polished	
(2) 38 YY	(2) 34	54-60 x 84	BYKEL760084S	S PO	2,630	2,980	2" black soft casters	polished	
(2) 32 YY	(2) 40	42-48 x 96	BYKEL748096S	S PO	2,600	2,950	2" black soft casters	polished	
(2) 38 YY	(2) 40	54-60 x 96	BYKEL760096S	S PO	2,650	3,000	2" black soft casters	polished	

Standard metal powder coat finishes (ME)

Black Wrinkle, Chateau Brown Wrinkle, Flat Black, Furniture White, Inner Tone, Light Tone, Medium Tone and Metallic Silver

Premium Polished Finishes (PO)



polished aluminum/steel

Note that the YY bases with 34 inch stretchers will not fit under a 54 x 72 or 60 x 72 racetrack top. Contact service@symphonytables.com for custom stretcher pricing.

The Keller YY bases with stretchers for the KEL5 category for boat, bullet media, half arced rectangle, half boat or rectangle tops will fit under trapezoid media tops with the exception of 42" deep tops with a 30" small end, increase the small end to 32 inches and the bases will fit. This is a non-standard top shape for us so please notate this clearly on your order.

# bases

## Keller YY + TT base(s) with stretchers

base	base qty + dim.	stretchers	max top support	base set model no.	list	glides	finish
Keller YY w/ TT base(s) and stretchers for use with a rectangular top (see chart on the opposite page for other shapes) (27.75"H)							
	(2) 32YY (1) 34TT	(4) 34	42-48 x 108	BYKEL848108S D G ME	3,230	adj glides	standard metal
	(2) 38YY (1) 40TT	(4) 34	54-60 x 108	BYKEL860108S D G ME	3,310	adj glides	standard metal
	(2) 32YY (1) 34TT	(4) 40	42-48 x 120	BYKEL848120S D G ME	3,270	adj glides	standard metal
	(2) 38YY (1) 40TT	(4) 40	54-60 x 120	BYKEL860120S D G ME	3,360	adj glides	standard metal
	(2) 32YY (1) 34TT	(4) 50	42-48 x 132-144	BYKEL848144S D G ME	3,450	adj glides	standard metal
	(2) 38YY (1) 40TT	(4) 50	54-60 x 132-144	BYKEL860144S D G ME	3,530	adj glides	standard metal
	(2) 32YY (1) 34TT	(4) 34	42-48 x 108	BYKEL848108S D G PO	4,240	adj glides	polished
	(2) 38YY (1) 40TT	(4) 34	54-60 x 108	BYKEL860108S D G PO	4,320	adj glides	polished
	(2) 32YY (1) 34TT	(4) 40	42-48 x 120	BYKEL848120S D G PO	4,300	adj glides	polished
	(2) 38YY (1) 40TT	(4) 40	54-60 x 120	BYKEL860120S D G PO	4,380	adj glides	polished
	(2) 32YY (1) 34TT	(4) 50	42-48 x 132-144	BYKEL848144S D G PO	4,500	adj glides	polished
	(2) 38YY (1) 40TT	(4) 50	54-60 x 132-144	BYKEL860144S D G PO	4,580	adj glides	polished
	(2) 32YY (2) 34TT	(6) 40	42-48 x 156-168	BYKEL848168S D G ME	4,460	adj glides	standard metal
	(2) 38YY (2) 40TT	(6) 40	54-60 x 156-168	BYKEL860168S D G ME	4,570	adj glides	standard metal
	(2) 32YY (2) 34TT	(6) 50	42-48 x 192	BYKEL848192S D G ME	4,720	adj glides	standard metal
	(2) 38YY (2) 40TT	(6) 50	54-60 x 192	BYKEL860192S D G ME	4,820	adj glides	standard metal
	(2) 32YY (2) 34TT	(6) 40	42-48 x 156-168	BYKEL848168S D G PO	5,890	adj glides	polished
	(2) 38YY (2) 40TT	(6) 40	54-60 x 156-168	BYKEL860168S D G PO	6,000	adj glides	polished
(2) 32YY (2) 34TT	(6) 50	42-48 x 192	BYKEL848192S D G PO	6,180	adj glides	polished	
(2) 38YY (2) 40TT	(6) 50	54-60 x 192	BYKEL860192S D G PO	6,290	adj glides	polished	

\* tops are not included in the pricing on this page. The chart shall be utilized as a reference for which bases will fit under the top sizes.

**Standard metal powder coat finishes (ME)**

Black Wrinkle, Chateau Brown Wrinkle, Flat Black, Furniture White, Inner Tone, Light Tone, Medium Tone and Metallic Silver







**Premium Polished Finishes (PO)**

polished aluminum/steel

# bases

## Keller YY + TT base(s) with stretchers

The base sizes for the model #'s in the same row on the opposite page will fit the top shapes/sizes indicated in the below chart:

							
	boat	bullet media	half arc rectangle	half boat	racetrack	trapezoid media	oval
42-48x108	42-48x108	42-48x108	42-48x108	48x108	42-48x108	48x108	48x132
54-60x108	-	-	54-60x108	54-60x108	-	54-60x108	60x132
42-48x120	42-48x120	42-48x120	42-48x120	48x120	42-48x120	48x120	48x144-156
54-60x120	-	-	54-60x120	54-60x120	-	54-60x120	60x144-156
48x132, 42-48x144	42-48x144	42-48x144	42-48x132-144	48x132-144	42-48x144	48x144	48x168
54-60x132-144	54-60x144	54-60x144	54-60x144	54-60x132-144	54-60x144	54-60x132-144	60x168
42-48x108	42-48x108	42-48x108	42-48x108	48x108	42-48x108	48x108	48x132
54-60x108	-	-	54-60x108	54-60x108	-	54-60x108	60x132
42-48x120	42-48x120	42-48x120	42-48x120	48x120	42-48x120	48x120	48x144-156
54-60x120	-	-	54-60x120	54-60x120	-	54-60x120	60x144-156
48x132, 42-48x144	42-48x144	42-48x144	42-48x132-144	48x132-144	42-48x144	48x144	48x168
54-60x132-144	54-60x144	54-60x144	54-60x144	54-60x132-144	54-60x144	54-60x132-144	60x168
48x156, 42-48x168	42-48x156-168	42-48x156-168	42-48x156-168	48x156-168	42-48x168	48x156-168	-
54-60x156-168	54-60x168	54-60x168	54-60x156-168	54-60x156-168	54-60x168	54-60x156-168	60x192
48x180, 48x192	42-48x192	42-48x192	42-48x192	48x180-192	42-48x192	42-48x192	-
54-60x192	54-60x192	54-60x192	54-60x192	54-60x192	-	54-60x192	-
48x156, 42-48x168	42-48x156-168	42-48x156-168	42-48x156-168	48x156-168	42-48x168	48x156-168	-
54-60x156-168	54-60x168	54-60x168	54-60x156-168	54-60x156-168	54-60x168	54-60x156-168	60x192
48x180, 48x192	42-48x192	42-48x192	42-48x192	48x180-192	42-48x192	42-48x192	-
54-60x192	54-60x192	54-60x192	54-60x192	54-60x192	-	54-60x192	-

# bases

## Ria Y with stretcher

For complete model number:

1. Insert height selection :

D dining height 27.75"H- see below chart for pricing

H custom higher height (specify height) - see below chart for pricing

L custom lower height (specify height) - see below chart for pricing

base	base qty + dim.	stretcher	max top support	base set model no.	<u>D</u> dining height list	<u>H</u> custom taller ht or <u>L</u> custom lower ht	glides or casters	finish	
Ria Y with stretcher for use with a rectangular top									
	(2) 17.5	(1) 40	24 x 60	BYRIA224060S	G ME	950	1,130	adj glides	standard metal
	(2) 23	(1) 40	30 x 60	BYRIA230060S	G ME	990	1,170	adj glides	standard metal
	(2) 29	(1) 34	36 x 60	BYRIA236060S	G ME	1,150	1,330	adj glides	standard metal
	(2) 33.5	(1) 34	48 x 60	BYRIA248060S	G ME	1,300	1,480	adj glides	standard metal
	(2) 17.5	(1) 50	24 x 72	BYRIA224072S	G ME	980	1,160	adj glides	standard metal
	(2) 23	(1) 50	30 x 72	BYRIA230072S	G ME	1,010	1,190	adj glides	standard metal
	(2) 29	(1) 40	36 x 72	BYRIA236072S	G ME	1,160	1,340	adj glides	standard metal
	(2) 33.5	(1) 40	48 x 72	BYRIA248072S	G ME	1,310	1,490	adj glides	standard metal
	(2) 29	(1) 50	36 x 84	BYRIA236084S	G ME	1,210	1,390	adj glides	standard metal
	(2) 33.5	(1) 50	48 x 84	BYRIA248084S	G ME	1,360	1,540	adj glides	standard metal
	(2) 29	(1) 58	36 x 96	BYRIA236096S	G ME	1,250	1,430	adj glides	standard metal
	(2) 33.5	(1) 58	48 x 96	BYRIA248096S	G ME	1,410	1,590	adj glides	standard metal
	(2) 17.5	(1) 40	24 x 60	BYRIA224060S	C ME	1,030	1,210	2" black hard casters	standard metal
	(2) 23	(1) 40	30 x 60	BYRIA230060S	C ME	1,070	1,250	2" black hard casters	standard metal
	(2) 29	(1) 34	36 x 60	BYRIA236060S	C ME	1,230	1,410	2" black hard casters	standard metal
	(2) 33.5	(1) 34	48 x 60	BYRIA248060S	C ME	1,380	1,560	2" black hard casters	standard metal
	(2) 17.5	(1) 50	24 x 72	BYRIA224072S	C ME	1,060	1,240	2" black hard casters	standard metal
	(2) 23	(1) 50	30 x 72	BYRIA230072S	C ME	1,090	1,270	2" black hard casters	standard metal
	(2) 29	(1) 40	36 x 72	BYRIA236072S	C ME	1,240	1,420	2" black hard casters	standard metal
	(2) 33.5	(1) 40	48 x 72	BYRIA248072S	C ME	1,390	1,570	2" black hard casters	standard metal
	(2) 29	(1) 50	36 x 84	BYRIA236084S	C ME	1,290	1,470	2" black hard casters	standard metal
	(2) 33.5	(1) 50	48 x 84	BYRIA248084S	C ME	1,440	1,620	2" black hard casters	standard metal
	(2) 29	(1) 58	36 x 96	BYRIA236096S	C ME	1,330	1,510	2" black hard casters	standard metal
	(2) 33.5	(1) 58	48 x 96	BYRIA248096S	C ME	1,490	1,670	2" black hard casters	standard metal
	(2) 17.5	(1) 40	24 x 60	BYRIA224060S	S ME	1,070	1,250	2" black soft casters	standard metal
	(2) 23	(1) 40	30 x 60	BYRIA230060S	S ME	1,110	1,290	2" black soft casters	standard metal
	(2) 29	(1) 34	36 x 60	BYRIA236060S	S ME	1,270	1,450	2" black soft casters	standard metal
	(2) 33.5	(1) 34	48 x 60	BYRIA248060S	S ME	1,420	1,600	2" black soft casters	standard metal
	(2) 17.5	(1) 50	24 x 72	BYRIA224072S	S ME	1,100	1,280	2" black soft casters	standard metal
	(2) 23	(1) 50	30 x 72	BYRIA230072S	S ME	1,130	1,310	2" black soft casters	standard metal
	(2) 29	(1) 40	36 x 72	BYRIA236072S	S ME	1,280	1,460	2" black soft casters	standard metal
	(2) 33.5	(1) 40	48 x 72	BYRIA248072S	S ME	1,430	1,610	2" black soft casters	standard metal
	(2) 29	(1) 50	36 x 84	BYRIA236084S	S ME	1,330	1,510	2" black soft casters	standard metal
	(2) 33.5	(1) 50	48 x 84	BYRIA248084S	S ME	1,480	1,660	2" black soft casters	standard metal
	(2) 29	(1) 58	36 x 96	BYRIA236096S	S ME	1,370	1,550	2" black soft casters	standard metal
	(2) 33.5	(1) 58	48 x 96	BYRIA248096S	S ME	1,530	1,710	2" black soft casters	standard metal
Ria Y with stretcher for use with a boat, half arced rectangle, half boat, bullet or racetrack top									
	(2) 33.5	(1) 34	48 x 72	BYRIA348072S	G ME	1,300	1,480	adj glides	standard metal
	(2) 33.5	(1) 40	48 x 84	BYRIA348084S	G ME	1,330	1,510	adj glides	standard metal
	(2) 33.5	(1) 50	48 x 96	BYRIA348096S	G ME	1,360	1,540	adj glides	standard metal
	(2) 33.5	(1) 34	48 x 72	BYRIA348072S	C ME	1,380	1,560	2" black hard casters	standard metal
	(2) 33.5	(1) 40	48 x 84	BYRIA348084S	C ME	1,410	1,590	2" black hard casters	standard metal
	(2) 33.5	(1) 50	48 x 96	BYRIA348096S	C ME	1,440	1,620	2" black hard casters	standard metal
	(2) 33.5	(1) 34	48 x 72	BYRIA348072S	S ME	1,420	1,600	2" black soft casters	standard metal
	(2) 33.5	(1) 40	48 x 84	BYRIA348084S	S ME	1,450	1,630	2" black soft casters	standard metal
	(2) 33.5	(1) 50	48 x 96	BYRIA348096S	S ME	1,480	1,660	2" black soft casters	standard metal
Ria Y with stretcher for use with an oval top									
	(2) 33.5	(1) 34	48 x 84	BYRIA448084S	G ME	1,300	1,480	adj glides	standard metal
	(2) 33.5	(1) 40	48 x 96	BYRIA448096S	G ME	1,330	1,510	adj glides	standard metal
	(2) 33.5	(1) 34	48 x 84	BYRIA448084S	C ME	1,380	1,560	2" black hard casters	standard metal
	(2) 33.5	(1) 40	48 x 96	BYRIA448096S	C ME	1,410	1,590	2" black hard casters	standard metal
	(2) 33.5	(1) 34	48 x 84	BYRIA448084S	S ME	1,420	1,600	2" black soft casters	standard metal
	(2) 33.5	(1) 40	48 x 96	BYRIA448096S	S ME	1,450	1,630	2" black soft casters	standard metal

**C casters**

2" black dual wheel locking hard casters (for carpet)



**S casters**

2" black dual wheel locking soft casters (for hard floors)

**Standard metal powder coat finishes (ME)**

Black Wrinkle, Chateau Brown Wrinkle, Flat Black, Furniture White, Inner Tone, Light Tone, Medium Tone and Metallic Silver

**Premium Polished Finishes (PO)**

polished aluminum/steel

# bases

## Ria Y base with stretcher

For complete model number:

1. Insert height selection :

D dining height 27.75"H- see below chart for pricing

H custom higher height (specify height) - see below chart for pricing



L custom lower height (specify height) - see below chart for pricing

base	base qty + dim.	stretcher	max top support	base set model no.	<u>D</u> dining height list	<u>H</u> custom taller ht or <u>L</u> custom lower ht	glides or casters	finish	
Ria Y with stretcher for use with a rectangular top									
	(2) 17.5	(1) 40	24 x 60	BYRIA224060S	G PO	1,240	1,420	adj glides	polished
	(2) 23	(1) 40	30 x 60	BYRIA230060S	G PO	1,280	1,460	adj glides	polished
	(2) 29	(1) 34	36 x 60	BYRIA236060S	G PO	1,430	1,610	adj glides	polished
	(2) 33.5	(1) 34	48 x 60	BYRIA248060S	G PO	1,590	1,770	adj glides	polished
	(2) 17.5	(1) 50	24 x 72	BYRIA224072S	G PO	1,280	1,460	adj glides	polished
	(2) 23	(1) 50	30 x 72	BYRIA230072S	G PO	1,310	1,490	adj glides	polished
	(2) 29	(1) 40	36 x 72	BYRIA236072S	G PO	1,450	1,630	adj glides	polished
	(2) 33.5	(1) 40	48 x 72	BYRIA248072S	G PO	1,600	1,780	adj glides	polished
	(2) 29	(1) 50	36 x 84	BYRIA236084S	G PO	1,510	1,690	adj glides	polished
	(2) 33.5	(1) 50	48 x 84	BYRIA248084S	G PO	1,660	1,840	adj glides	polished
	(2) 29	(1) 58	36 x 96	BYRIA236096S	G PO	1,760	1,940	adj glides	polished
	(2) 33.5	(1) 58	48 x 96	BYRIA248096S	G PO	1,910	2,090	adj glides	polished
	(2) 17.5	(1) 40	24 x 60	BYRIA224060S	C PO	1,320	1,500	2" black hard casters	polished
	(2) 23	(1) 40	30 x 60	BYRIA230060S	C PO	1,360	1,540	2" black hard casters	polished
	(2) 29	(1) 34	36 x 60	BYRIA236060S	C PO	1,510	1,690	2" black hard casters	polished
	(2) 33.5	(1) 34	48 x 60	BYRIA248060S	C PO	1,670	1,850	2" black hard casters	polished
	(2) 17.5	(1) 50	24 x 72	BYRIA224072S	C PO	1,360	1,540	2" black hard casters	polished
	(2) 23	(1) 50	30 x 72	BYRIA230072S	C PO	1,390	1,570	2" black hard casters	polished
	(2) 29	(1) 40	36 x 72	BYRIA236072S	C PO	1,530	1,710	2" black hard casters	polished
	(2) 33.5	(1) 40	48 x 72	BYRIA248072S	C PO	1,680	1,860	2" black hard casters	polished
	(2) 29	(1) 50	36 x 84	BYRIA236084S	C PO	1,590	1,770	2" black hard casters	polished
	(2) 33.5	(1) 50	48 x 84	BYRIA248084S	C PO	1,740	1,920	2" black hard casters	polished
	(2) 29	(1) 58	36 x 96	BYRIA236096S	C PO	1,840	2,020	2" black hard casters	polished
	(2) 33.5	(1) 58	48 x 96	BYRIA248096S	C PO	1,990	2,170	2" black hard casters	polished
	(2) 17.5	(1) 40	24 x 60	BYRIA224060S	S PO	1,360	1,540	2" black soft casters	polished
	(2) 23	(1) 40	30 x 60	BYRIA230060S	S PO	1,400	1,580	2" black soft casters	polished
	(2) 29	(1) 34	36 x 60	BYRIA236060S	S PO	1,550	1,730	2" black soft casters	polished
	(2) 33.5	(1) 34	48 x 60	BYRIA248060S	S PO	1,710	1,890	2" black soft casters	polished
	(2) 17.5	(1) 50	24 x 72	BYRIA224072S	S PO	1,400	1,580	2" black soft casters	polished
	(2) 23	(1) 50	30 x 72	BYRIA230072S	S PO	1,430	1,610	2" black soft casters	polished
	(2) 29	(1) 40	36 x 72	BYRIA236072S	S PO	1,570	1,750	2" black soft casters	polished
	(2) 33.5	(1) 40	48 x 72	BYRIA248072S	S PO	1,720	1,900	2" black soft casters	polished
	(2) 29	(1) 50	36 x 84	BYRIA236084S	S PO	1,630	1,810	2" black soft casters	polished
	(2) 33.5	(1) 50	48 x 84	BYRIA248084S	S PO	1,780	1,960	2" black soft casters	polished
	(2) 29	(1) 58	36 x 96	BYRIA236096S	S PO	1,880	2,060	2" black soft casters	polished
	(2) 33.5	(1) 58	48 x 96	BYRIA248096S	S PO	2,030	2,210	2" black soft casters	polished
Ria Y with stretcher for use with a boat, half boat, bullet or racetrack top									
	(2) 33.5	(1) 34	48 x 72	BYRIA348072S	G PO	1,590	1,770	adj glides	polished
	(2) 33.5	(1) 40	48 x 84	BYRIA348084S	G PO	1,630	1,810	adj glides	polished
	(2) 33.5	(1) 50	48 x 96	BYRIA348096S	G PO	1,660	1,840	adj glides	polished
	(2) 33.5	(1) 34	48 x 72	BYRIA348072S	C PO	1,670	1,850	2" black hard casters	polished
	(2) 33.5	(1) 40	48 x 84	BYRIA348084S	C PO	1,710	1,890	2" black hard casters	polished
	(2) 33.5	(1) 50	48 x 96	BYRIA348096S	C PO	1,740	1,920	2" black hard casters	polished
	(2) 33.5	(1) 34	48 x 72	BYRIA348072S	S PO	1,710	1,890	2" black soft casters	polished
	(2) 33.5	(1) 40	48 x 84	BYRIA348084S	S PO	1,750	1,930	2" black soft casters	polished
	(2) 33.5	(1) 50	48 x 96	BYRIA348096S	S PO	1,780	1,960	2" black soft casters	polished
Ria Y with stretcher for use with an oval top									
	(2) 33.5	(1) 34	48 x 84	BYRIA448084S	G PO	1,590	1,770	adj glides	polished
	(2) 33.5	(1) 40	48 x 96	BYRIA448096S	G PO	1,630	1,810	adj glides	

# bases

## Ria YY bases with stretchers

For complete model number:  
 1. Insert height selection :  
 D dining height 27.75"H- see below chart for pricing  
 H custom higher height (specify height) - see below chart for pricing  
 L custom lower height (specify height) - see below chart for pricing

base	base qty + dim.	stretchers	max top support	base set model no.	D dining height list	H custom taller ht or L custom lower ht list	glides or casters	finish		
Ria YY with stretchers for use with a boat, bullet media, half arced rectangle, half boat, or rectangle top										
	(2) 32 YY	(2) 34	42-48 x 72	BYRIA548072S	G ME	1,860	2,160	adj glides	standard metal	
	(2) 38 YY	(2) 34	54-60 x 72	BYRIA560072S	G ME	1,910	2,210	adj glides	standard metal	
	(2) 32 YY	(2) 40	42-48 x 84	BYRIA548084S	G ME	1,880	2,180	adj glides	standard metal	
	(2) 38 YY	(2) 40	54-60 x 84	BYRIA560084S	G ME	1,940	2,240	adj glides	standard metal	
	(2) 32 YY	(2) 50	42-48 x 96	BYRIA548096S	G ME	1,940	2,240	adj glides	standard metal	
	(2) 38 YY	(2) 50	54-60 x 96	BYRIA560096S	G ME	1,990	2,290	adj glides	standard metal	
	(2) 32 YY	(2) 34	42-48 x 72	BYRIA548072S	C ME	1,940	2,240	2" black hard casters	standard metal	
	(2) 38 YY	(2) 34	54-60 x 72	BYRIA560072S	C ME	1,990	2,290	2" black hard casters	standard metal	
	(2) 32 YY	(2) 40	42-48 x 84	BYRIA548084S	C ME	1,960	2,260	2" black hard casters	standard metal	
	(2) 38 YY	(2) 40	54-60 x 84	BYRIA560084S	C ME	2,020	2,320	2" black hard casters	standard metal	
	(2) 32 YY	(2) 50	42-48 x 96	BYRIA548096S	C ME	2,020	2,320	2" black hard casters	standard metal	
	(2) 38 YY	(2) 50	54-60 x 96	BYRIA560096S	C ME	2,070	2,370	2" black hard casters	standard metal	
	(2) 32 YY	(2) 34	42-48 x 72	BYRIA548072S	S ME	1,980	2,280	2" black soft casters	standard metal	
	(2) 38 YY	(2) 34	54-60 x 72	BYRIA560072S	S ME	2,030	2,330	2" black soft casters	standard metal	
	(2) 32 YY	(2) 40	42-48 x 84	BYRIA548084S	S ME	2,000	2,300	2" black soft casters	standard metal	
	(2) 38 YY	(2) 40	54-60 x 84	BYRIA560084S	S ME	2,060	2,360	2" black soft casters	standard metal	
	(2) 32 YY	(2) 50	42-48 x 96	BYRIA548096S	S ME	2,060	2,360	2" black soft casters	standard metal	
	(2) 38 YY	(2) 50	54-60 x 96	BYRIA560096S	S ME	2,110	2,410	2" black soft casters	standard metal	
Ria YY with stretchers for use with a racetrack top										
	(2) 32 YY	(2) 34	42-48 x 72	BYRIA648072S	G ME	1,860	2,160	adj glides	standard metal	
	(2) 32 YY	(2) 40	42-48 x 84	BYRIA648084S	G ME	1,880	2,180	adj glides	standard metal	
	(2) 38 YY	(2) 40	54-60 x 84	BYRIA660084S	G ME	1,940	2,240	adj glides	standard metal	
	(2) 32 YY	(2) 50	42-48 x 96	BYRIA648096S	G ME	1,940	2,240	adj glides	standard metal	
	(2) 38 YY	(2) 50	54-60 x 96	BYRIA660096S	G ME	1,990	2,290	adj glides	standard metal	
	(2) 32 YY	(2) 34	42-48 x 72	BYRIA648072S	C ME	1,940	2,240	2" black hard casters	standard metal	
	(2) 32 YY	(2) 40	42-48 x 84	BYRIA648084S	C ME	1,960	2,260	2" black hard casters	standard metal	
	(2) 38 YY	(2) 40	54-60 x 84	BYRIA660084S	C ME	2,020	2,320	2" black hard casters	standard metal	
	(2) 32 YY	(2) 50	42-48 x 96	BYRIA648096S	C ME	2,020	2,320	2" black hard casters	standard metal	
	(2) 38 YY	(2) 50	54-60 x 96	BYRIA660096S	C ME	2,070	2,370	2" black hard casters	standard metal	
	(2) 32 YY	(2) 34	42-48 x 72	BYRIA648072S	S ME	1,980	2,280	2" black soft casters	standard metal	
	(2) 32 YY	(2) 40	42-48 x 84	BYRIA648084S	S ME	2,000	2,300	2" black soft casters	standard metal	
	(2) 38 YY	(2) 40	54-60 x 84	BYRIA660084S	S ME	2,060	2,360	2" black soft casters	standard metal	
	(2) 32 YY	(2) 50	42-48 x 96	BYRIA648096S	S ME	2,060	2,360	2" black soft casters	standard metal	
	(2) 38 YY	(2) 50	54-60 x 96	BYRIA660096S	S ME	2,110	2,410	2" black soft casters	standard metal	
	Ria YY with stretchers for use with an oval top									
		(2) 32 YY	(2) 34	48 x 84	BYRIA748084S	G ME	1,860	2,160	adj glides	standard metal
		(2) 38 YY	(2) 34	54-60 x 84	BYRIA760084S	G ME	1,910	2,210	adj glides	standard metal
(2) 32 YY		(2) 40	42-48 x 96	BYRIA748096S	G ME	1,880	2,180	adj glides	standard metal	
(2) 38 YY		(2) 40	54-60 x 96	BYRIA760096S	G ME	1,940	2,240	adj glides	standard metal	
(2) 32 YY		(2) 34	48 x 84	BYRIA748084S	C ME	1,940	2,240	2" black hard casters	standard metal	
(2) 38 YY		(2) 34	54-60 x 84	BYRIA760084S	C ME	1,990	2,290	2" black hard casters	standard metal	
(2) 32 YY		(2) 40	42-48 x 96	BYRIA748096S	C ME	1,960	2,260	2" black hard casters	standard metal	
(2) 38 YY		(2) 40	54-60 x 96	BYRIA760096S	C ME	2,020	2,320	2" black hard casters	standard metal	
(2) 32 YY		(2) 34	48 x 84	BYRIA748084S	S ME	1,980	2,280	2" black soft casters	standard metal	
(2) 38 YY		(2) 34	54-60 x 84	BYRIA760084S	S ME	2,030	2,330	2" black soft casters	standard metal	
(2) 32 YY		(2) 40	42-48 x 96	BYRIA748096S	S ME	2,000	2,300	2" black soft casters	standard metal	
(2) 38 YY		(2) 40	54-60 x 96	BYRIA760096S	S ME	2,060	2,360	2" black soft casters	standard metal	

Standard metal powder coat finishes (ME)  
 Black Wrinkle, Chateau Brown Wrinkle, Flat Black, Furniture White, Inner Tone, Light Tone, Medium Tone and Metallic Silver

Premium Polished Finishes (PO)  
 polished aluminum/steel



Note that the YY bases with 34 inch stretchers will not fit under a 54 x 72 or 60 x 72 racetrack top. Contact service@symphonytables.com for custom stretcher pricing.

The Ria YY bases with stretchers for the RIA5 category for boat, bullet media, half arced rectangle, half boat or rectangle tops will fit under trapezoid media tops with the exception of 42" deep tops with a 30" small end, increase the small end to 32 inches and the bases will fit. This is a non-standard top shape for us so please notate this clearly on your order.

# bases

## Ria YY bases with stretchers

For complete model number:  
 1. Insert height selection :  
 D dining height 27.75"H- see below chart for pricing  
 H custom higher height (specify height) - see below chart for pricing  
 L custom lower height (specify height) - see below chart for pricing

base	base qty + dim.	stretchers	max top support	base set model no.	D dining height list	H custom taller ht or L custom lower ht list	glides or casters	finish		
Ria YY with stretchers for use with a boat, bullet media, half arced rectangle, half boat, or rectangle top										
	(2) 32 YY	(2) 34	42-48 x 72	BYRIA548072S	G PO	2,440	2,790	adj glides	polished	
	(2) 38 YY	(2) 34	54-60 x 72	BYRIA560072S	G PO	2,500	2,850	adj glides	polished	
	(2) 32 YY	(2) 40	42-48 x 84	BYRIA548084S	G PO	2,480	2,830	adj glides	polished	
	(2) 38 YY	(2) 40	54-60 x 84	BYRIA560084S	G PO	2,530	2,880	adj glides	polished	
	(2) 32 YY	(2) 50	42-48 x 96	BYRIA548096S	G PO	2,540	2,890	adj glides	polished	
	(2) 38 YY	(2) 50	54-60 x 96	BYRIA560096S	G PO	2,600	2,950	adj glides	polished	
	(2) 32 YY	(2) 34	42-48 x 72	BYRIA548072S	C PO	2,520	2,870	2" black hard casters	polished	
	(2) 38 YY	(2) 34	54-60 x 72	BYRIA560072S	C PO	2,580	2,930	2" black hard casters	polished	
	(2) 32 YY	(2) 40	42-48 x 84	BYRIA548084S	C PO	2,560	2,910	2" black hard casters	polished	
	(2) 38 YY	(2) 40	54-60 x 84	BYRIA560084S	C PO	2,610	2,960	2" black hard casters	polished	
	(2) 32 YY	(2) 50	42-48 x 96	BYRIA548096S	C PO	2,620	2,970	2" black hard casters	polished	
	(2) 38 YY	(2) 50	54-60 x 96	BYRIA560096S	C PO	2,680	3,030	2" black hard casters	polished	
	(2) 32 YY	(2) 34	42-48 x 72	BYRIA548072S	S PO	2,560	2,910	2" black soft casters	polished	
	(2) 38 YY	(2) 34	54-60 x 72	BYRIA560072S	S PO	2,620	2,970	2" black soft casters	polished	
	(2) 32 YY	(2) 40	42-48 x 84	BYRIA548084S	S PO	2,600	2,950	2" black soft casters	polished	
	(2) 38 YY	(2) 40	54-60 x 84	BYRIA560084S	S PO	2,650	3,000	2" black soft casters	polished	
	(2) 32 YY	(2) 50	42-48 x 96	BYRIA548096S	S PO	2,660	3,010	2" black soft casters	polished	
	(2) 38 YY	(2) 50	54-60 x 96	BYRIA560096S	S PO	2,720	3,070	2" black soft casters	polished	
Ria YY with stretchers for use with a racetrack top										
	(2) 32 YY	(2) 34	42-48 x 72	BYRIA648072S	G PO	2,440	2,790	adj glides	polished	
	(2) 32 YY	(2) 40	42-48 x 84	BYRIA648084S	G PO	2,480	2,830	adj glides	polished	
	(2) 38 YY	(2) 40	54-60 x 84	BYRIA660084S	G PO	2,530	2,880	adj glides	polished	
	(2) 32 YY	(2) 50	42-48 x 96	BYRIA648096S	G PO	2,540	2,890	adj glides	polished	
	(2) 38 YY	(2) 50	54-60 x 96	BYRIA660096S	G PO	2,600	2,950	adj glides	polished	
	(2) 32 YY	(2) 34	42-48 x 72	BYRIA648072S	C PO	2,520	2,870	2" black hard casters	polished	
	(2) 32 YY	(2) 40	42-48 x 84	BYRIA648084S	C PO	2,560	2,910	2" black hard casters	polished	
	(2) 38 YY	(2) 40	54-60 x 84	BYRIA660084S	C PO	2,610	2,960	2" black hard casters	polished	
	(2) 32 YY	(2) 50	42-48 x 96	BYRIA648096S	C PO	2,620	2,970	2" black hard casters	polished	
	(2) 38 YY	(2) 50	54-60 x 96	BYRIA660096S	C PO	2,680	3,030	2" black hard casters	polished	
	(2) 32 YY	(2) 34	42-48 x 72	BYRIA648072S	S PO	2,560	2,910	2" black soft casters	polished	
	(2) 32 YY	(2) 40	42-48 x 84	BYRIA648084S	S PO	2,600	2,950	2" black soft casters	polished	
	(2) 38 YY	(2) 40	54-60 x 84	BYRIA660084S	S PO	2,650	3,000	2" black soft casters	polished	
	(2) 32 YY	(2) 50	42-48 x 96	BYRIA648096S	S PO	2,660	3,010	2" black soft casters	polished	
	(2) 38 YY	(2) 50	54-60 x 96	BYRIA660096S	S PO	2,720	3,070	2" black soft casters	polished	
	Ria YY with stretchers for use with an oval top									
		(2) 32 YY	(2) 34	48 x 84	BYRIA748084S	G PO	2,440	2,790	adj glides	polished
		(2) 38 YY	(2) 34	54-60 x 84	BYRIA760084S	G PO	2,500	2,850	adj glides	polished
(2) 32 YY		(2) 40	42-48 x 96	BYRIA748096S	G PO	2,480	2,830	adj glides	polished	
(2) 38 YY		(2) 40	54-60 x 96	BYRIA760096S	G PO	2,530	2,880	adj glides	polished	
(2) 32 YY		(2) 34	48 x 84	BYRIA748084S	C PO	2,520	2,870	2" black hard casters	polished	
(2) 38 YY		(2) 34	54-60 x 84	BYRIA760084S	C PO	2,580	2,930	2" black hard casters	polished	
(2) 32 YY		(2) 40	42-48 x 96	BYRIA748096S	C PO	2,560	2,910	2" black hard casters	polished	
(2) 38 YY		(2) 40	54-60 x 96	BYRIA760096S	C PO	2,610	2,960	2" black hard casters	polished	
(2) 32 YY		(2) 34	48 x 84	BYRIA748084S	S PO	2,560	2,910	2" black soft casters	polished	
(2) 38 YY		(2) 34	54-60 x 84	BYRIA760084S	S PO	2,620	2,970	2" black soft casters	polished	
(2) 32 YY		(2) 40	42-48 x 96	BYRIA748096S	S PO	2,600	2,950	2" black soft casters	polished	
(2) 38 YY		(2) 40	54-60 x 96	BYRIA760096S	S PO	2,650	3,000	2" black soft casters	polished	

Standard metal powder coat finishes (ME)  
 Black Wrinkle, Chateau Brown Wrinkle, Flat Black, Furniture White, Inner Tone, Light Tone, Medium Tone and Metallic Silver











Premium Polished Finishes (PO)  
 polished aluminum/steel

Note that the YY bases with 34 inch stretchers will not fit under a 54 x 72 or 60 x 72 racetrack top. Contact service@symphonytables.com for custom stretcher pricing.

The Ria YY bases with stretchers for the RIA5 category for boat, bullet media, half arced rectangle, half boat or rectangle tops will fit under trapezoid media tops with the exception of 42" deep tops with a 30" small end, increase the small end to 32 inches and the bases will fit. This is a non-standard top shape for us so please notate this clearly on your order.

# bases

## Ria YY + TT base(s) with stretchers

base	base qty + dim.	stretchers	max top support	base set model no.	list	glides	finish
Ria YY w/ TT base(s) and stretchers for use with a rectangular top (see chart on the opposite page for other shapes) (27.75"H)							
	(2) 32YY (1) 34TT	(4) 34	42-48 x 108	BYRIA848108S D G ME	2,940	adj glides	standard metal
	(2) 38YY (1) 40TT	(4) 34	54-60 x 108	BYRIA860108S D G ME	3,010	adj glides	standard metal
	(2) 32YY (1) 34TT	(4) 40	42-48 x 120	BYRIA848120S D G ME	2,980	adj glides	standard metal
	(2) 38YY (1) 40TT	(4) 40	54-60 x 120	BYRIA860120S D G ME	3,060	adj glides	standard metal
	(2) 32YY (1) 34TT	(4) 50	42-48 x 132-144	BYRIA848144S D G ME	3,090	adj glides	standard metal
	(2) 38YY (1) 40TT	(4) 50	54-60 x 132-144	BYRIA860144S D G ME	3,170	adj glides	standard metal
	(2) 32YY (1) 34TT	(4) 34	42-48 x 108	BYRIA848108S D G PO	3,910	adj glides	polished
	(2) 38YY (1) 40TT	(4) 34	54-60 x 108	BYRIA860108S D G PO	3,980	adj glides	polished
	(2) 32YY (1) 34TT	(4) 40	42-48 x 120	BYRIA848120S D G PO	3,970	adj glides	polished
	(2) 38YY (1) 40TT	(4) 40	54-60 x 120	BYRIA860120S D G PO	4,040	adj glides	polished
	(2) 32YY (1) 34TT	(4) 50	42-48 x 132-144	BYRIA848144S D G PO	4,100	adj glides	polished
	(2) 38YY (1) 40TT	(4) 50	54-60 x 132-144	BYRIA860144S D G PO	4,180	adj glides	polished
	(2) 32YY (2) 34TT	(6) 40	42-48 x 156-168	BYRIA848168S D G ME	3,550	adj glides	standard metal
	(2) 38YY (2) 40TT	(6) 40	54-60 x 156-168	BYRIA860168S D G ME	3,630	adj glides	standard metal
	(2) 32YY (2) 34TT	(6) 50	42-48 x 192	BYRIA848192S D G ME	3,720	adj glides	standard metal
	(2) 38YY (2) 40TT	(6) 50	54-60 x 192	BYRIA860192S D G ME	3,790	adj glides	standard metal
	(2) 32YY (2) 34TT	(6) 40	42-48 x 156-168	BYRIA848168S D G PO	4,250	adj glides	polished
	(2) 38YY (2) 40TT	(6) 40	54-60 x 156-168	BYRIA860168S D G PO	4,330	adj glides	polished
	(2) 32YY (2) 34TT	(6) 50	42-48 x 192	BYRIA848192S D G PO	4,400	adj glides	polished
	(2) 38YY (2) 40TT	(6) 50	54-60 x 192	BYRIA860192S D G PO	4,470	adj glides	polished

\* tops are not included in the pricing on this page. The chart shall be utilized as a reference for which bases will fit under the top sizes.

**Standard metal powder coat finishes (ME)**

Black Wrinkle, Chateau Brown Wrinkle, Flat Black, Furniture White, Inner Tone, Light Tone, Medium Tone and Metallic Silver







**Premium Polished Finishes (PO)**

polished aluminum/steel

# bases

## Ria YY + TT base(s) with stretchers

The base sizes for the model #'s in the same row on the opposite page will fit the top shapes/sizes indicated in the below chart:

							
	boat	bullet media	half arc rectangle	half boat	racetrack	trapezoid media	oval
42-48x108	42-48x108	42-48x108	42-48x108	48x108	42-48x108	48x108	48x132
54-60x108	-	-	54-60x108	54-60x108	-	54-60x108	60x132
42-48x120	42-48x120	42-48x120	42-48x120	48x120	42-48x120	48x120	48x144-156
54-60x120	-	-	54-60x120	54-60x120	-	54-60x120	60x144-156
48x132, 42-48x144	42-48x144	42-48x144	42-48x132-144	48x132-144	42-48x144	48x144	48x168
54-60x132-144	54-60x144	54-60x144	54-60x144	54-60x132-144	54-60x144	54-60x132-144	60x168
42-48x108	42-48x108	42-48x108	42-48x108	48x108	42-48x108	48x108	48x132
54-60x108	-	-	54-60x108	54-60x108	-	54-60x108	60x132
42-48x120	42-48x120	42-48x120	42-48x120	48x120	42-48x120	48x120	48x144-156
54-60x120	-	-	54-60x120	54-60x120	-	54-60x120	60x144-156
48x132, 42-48x144	42-48x144	42-48x144	42-48x132-144	48x132-144	42-48x144	48x144	48x168
54-60x132-144	54-60x144	54-60x144	54-60x144	54-60x132-144	54-60x144	54-60x132-144	60x168
48x156, 42-48x168	42-48x156-168	42-48x156-168	42-48x156-168	48x156-168	42-48x168	48x156-168	-
54-60x156-168	54-60x168	54-60x168	54-60x156-168	54-60x156-168	54-60x168	54-60x156-168	60x192
48x180, 48x192	42-48x192	42-48x192	42-48x192	48x180-192	42-48x192	42-48x192	-
54-60x192	54-60x192	54-60x192	54-60x192	54-60x192	-	54-60x192	-
48x156, 42-48x168	42-48x156-168	42-48x156-168	42-48x156-168	48x156-168	42-48x168	48x156-168	-
54-60x156-168	54-60x168	54-60x168	54-60x156-168	54-60x156-168	54-60x168	54-60x156-168	60x192
48x180, 48x192	42-48x192	42-48x192	42-48x192	48x180-192	42-48x192	42-48x192	-
54-60x192	54-60x192	54-60x192	54-60x192	54-60x192	-	54-60x192	-

# bases

## Zoey conference bases

For complete model number:

1. Insert height selection :

D dining height 27.75"H- see below chart for pricing

B bar height 40.75"H - see below chart for pricing

version	end base qty + dim.	middle base qty + dim.	stretcher(s)	max top support	base set model no.	dining height <u>D</u> 27.75H list	bar height <u>B</u> 40.75H list
Zoey Y base with stretcher(s) for use with a <b>rectangle top</b> (top is not included in the price)							
single stretcher	(2) 19	n/a	(1) 16	24 x 48	BYZO224048RES _ G ME	1,080	n/a
	(2) 19	n/a	(1) 29	24 x 60	BYZO224060RES _ G ME	1,100	1,280
	(2) 19	n/a	(1) 39	24 x 72	BYZO224072RES _ G ME	1,130	1,300
	(2) 24	n/a	(1) 12	30 x 48	BYZO230048RES _ G ME	1,090	1,250
	(2) 24	n/a	(1) 24	30 x 60	BYZO230060RES _ G ME	1,130	1,290
	(2) 24	n/a	(1) 35	30 x 72	BYZO230072RES _ G ME	1,140	1,310
	(2) 24	n/a	(1) 24	36 x 60	BYZO236060RES _ G ME	1,280	1,440
	(2) 24	n/a	(1) 29	36 x 66	BYZO236066RES _ G ME	1,290	1,450
	(2) 24	n/a	(1) 35	36 x 72	BYZO236072RES _ G ME	1,300	1,460
	(2) 24	n/a	(1) 47	36 x 84	BYZO236084RES _ G ME	1,350	1,510
double stretcher	(2) 24	n/a	(1) 58	36 x 96	BYZO236096RES _ G ME	1,400	1,570
	(2) 24	n/a	(1) 24	42 x 60	BYZO242060RES _ G ME	1,280	1,440
	(2) 24	n/a	(1) 35	42 x 72	BYZO242072RES _ G ME	1,300	1,460
	(2) 24	n/a	(1) 47	42 x 84	BYZO242084RES _ G ME	1,350	1,510
	(2) 24	n/a	(1) 58	42 x 96	BYZO242096RES _ G ME	1,400	1,570
	(2) 35	n/a	(2) 24	48 x 60	BYZO248060RED _ G ME	1,900	2,010
	(2) 35	n/a	(2) 35	48 x 72	BYZO248072RED _ G ME	1,940	2,040
	(2) 35	n/a	(2) 47	48 x 84	BYZO248084RED _ G ME	2,020	2,280
	(2) 35	n/a	(2) 58	48 x 96	BYZO248096RED _ G ME	2,110	2,380
	(2) 35	(1) 38	(4) 39	48 x 120	BYZO248120RED _ G ME	3,110	n/a
double stretcher	(2) 35	(1) 38	(4) 52	48 x 144	BYZO248144RED _ G ME	3,250	n/a
	(2) 40	n/a	(2) 24	54 x 60	BYZO254060RED _ G ME	1,930	2,190
	(2) 40	n/a	(2) 35	54 x 72	BYZO254072RED _ G ME	1,960	2,220
	(2) 40	n/a	(2) 47	54 x 84	BYZO254084RED _ G ME	2,050	2,310
	(2) 40	n/a	(2) 52	54 x 96	BYZO254096RED _ G ME	2,070	2,340
	(2) 40	(1) 42	(4) 39	54 x 120	BYZO254120RED _ G ME	3,150	n/a
	(2) 40	(1) 42	(4) 52	54 x 144	BYZO254144RED _ G ME	3,280	n/a
	(2) 44	n/a	(2) 29	60 x 66	BYZO260066RED _ G ME	1,970	2,230
	(2) 44	n/a	(2) 35	60 x 72	BYZO260072RED _ G ME	1,970	2,240
	(2) 44	n/a	(2) 47	60 x 84	BYZO260084RED _ G ME	2,070	2,330
double stretcher	(2) 44	n/a	(2) 58	60 x 96	BYZO260096RED _ G ME	2,170	2,420
	(2) 44	(1) 47	(4) 39	60 x 120	BYZO260120RED _ G ME	3,180	n/a
	(2) 44	(1) 47	(4) 52	60 x 144	BYZO260144RED _ G ME	3,300	n/a

Standard metal powder coat finishes (ME)

Flat Black, Furniture White, Inner Tone, Light Tone, Medium Tone and Metallic Silver

# bases

## Zoey conference bases

For complete model number:

1. Insert height selection :

D dining height 27.75"H- see below chart for pricing

B bar height 40.75"H - see below chart for pricing

version	end base qty + dim.	middle base qty + dim.	stretcher(s)	max top support	base set model no.	dining height <u>D</u> 27.75H list	bar height <u>B</u> 40.75H list
Zoey Y base with stretcher(s) for use with a <b>Bullet Media top</b> (top is not included in the price)							
single stretcher	(2) 24	n/a	(1) 35	36 x 72	BYZO236072BUS _ G ME	1,300	1,460
	(2) 24	n/a	(1) 24	42 x 60	BYZO242060BUS _ G ME	1,280	1,440
	(2) 24	n/a	(1) 35	42 x 72	BYZO242072BUS _ G ME	1,300	1,460
	(2) 24	n/a	(1) 47	42 x 84	BYZO242084BUS _ G ME	1,350	1,510
	(2) 24	n/a	(1) 58	42 x 96	BYZO242096BUS _ G ME	1,400	1,570
double stretcher	(2) 35	n/a	(2) 24	48 x 60	BYZO248060BUD _ G ME	1,870	2,120
	(2) 35	n/a	(2) 35	48 x 72	BYZO248072BUD _ G ME	1,930	2,190
	(2) 35	n/a	(2) 47	48 x 84	BYZO248084BUD _ G ME	1,960	2,220
	(2) 35	n/a	(2) 58	48 x 96	BYZO248096BUD _ G ME	2,060	2,320
	(2) 40	n/a	(2) 24	54 x 60	BYZO254060BUD _ G ME	1,890	2,150
	(2) 40	n/a	(2) 35	54 x 72	BYZO254072BUD _ G ME	1,950	2,210
	(2) 40	n/a	(2) 47	54 x 84	BYZO254084BUD _ G ME	1,980	2,240
	(2) 40	n/a	(2) 52	54 x 96	BYZO254096BUD _ G ME	2,070	2,340
	(2) 44	n/a	(2) 29	60 x 66	BYZO260066BUD _ G ME	1,950	2,210
	(2) 44	n/a	(2) 35	60 x 72	BYZO260072BUD _ G ME	1,970	2,230
double stretcher	(2) 44	n/a	(2) 47	60 x 84	BYZO260084BUD _ G ME	1,990	2,270
	(2) 44	n/a	(2) 58	60 x 96	BYZO260096BUD _ G ME	2,090	2,350
	(2) 24	n/a	(1) 35	36 x 72	BYZO236072HAS _ G ME	1,300	1,460
	(2) 24	n/a	(1) 24	42 x 60	BYZO242060HAS _ G ME	1,280	1,440
single stretcher	(2) 24	n/a	(1) 35	42 x 72	BYZO242072HAS _ G ME	1,300	1,460
	(2) 24	n/a	(1) 47	42 x 84	BYZO242084HAS _ G ME	1,350	1,510
	(2) 35	n/a	(2) 24	48 x 60	BYZO248060HAD _ G ME	1,870	2,120
	(2) 35	n/a	(2) 35	48 x 72	BYZO248072HAD _ G ME	1,930	2,190
double stretcher	(2) 35	n/a	(2) 47	48 x 84	BYZO248084HAD _ G ME	1,960	2,220
	(2) 35	n/a	(2) 58	48 x 96	BYZO248096HAD _ G ME	2,060	2,320
	(2) 40	n/a	(2) 24	54 x 60	BYZO254060HAD _ G ME	1,890	2,150
	(2) 40	n/a	(2) 35	54 x 72	BYZO254072HAD _ G ME	1,950	2,210
	(2) 40	n/a	(2) 47	54 x 84	BYZO254084HAD _ G ME	1,980	2,240
	(2) 40	n/a	(2) 52	54 x 96	BYZO254096HAD _ G ME	2,070	2,340
	(2) 44	n/a	(2) 29	60 x 66	BYZO260066HAD _ G ME	1,950	2,210
	(2) 44	n/a	(2) 35	60 x 72	BYZO260072HAD _ G ME	1,970	2,230
	(2) 44	n/a	(2) 47	60 x 84	BYZO260084HAD _ G ME	1,990	2,270
	(2) 44	n/a	(2) 58	60 x 96	BYZO260096HAD _ G ME	2,090	2,350

Standard metal powder coat finishes (ME)





Flat Black, Furniture White, Inner Tone, Light Tone, Medium Tone and Metallic Silver

\* Zoey Conference can be used on other top shapes, email [service@symphonytables.com](mailto:service@symphonytables.com) for pricing.

# bases

## Borne & Bati post

### Canty frame

base	max top support	base description	mount plate	qty	model no.	list
<b>Borne base sets (4)</b>						
	48 x 48, 60 rd	2" dia column x 27.75"H, adj glides	4 x 4	4	BPBOR4S02RSDGME	620
	48 x 48	2" dia column cust higher ht, adj glides	4 x 4	4	BPBOR4S02RSHGME	950
	48 x 48, 60 rd	2" dia column cust shorter ht, adj glides	4 x 4	4	BPBOR4S02RSLGME	860
	48 x 48	2" dia column x 27.75"H, 2" black casters	4 x 4	4	BPBOR4S02RSDCME	720
	48 x 48	2" dia column cust higher ht, 2" black casters	4 x 4	4	BPBOR4S02RSHCME	1,050
	48 x 48	2" dia column cust shorter ht, 2" black casters	4 x 4	4	BPBOR4S02RSLCME	950
	48 x 48	2" dia column x 27.75"H, 2" silver/black casters	4 x 4	4	BPBOR4S02RSDPME	760
	48 x 48	2" dia column higher ht, 2" silver/black casters	4 x 4	4	BPBOR4S02RSHPME	1,090
	48 x 48	2" dia column shorter ht, 2" silver/black casters	4 x 4	4	BPBOR4S02RSLPME	1,000
<b>Borne single base (1)</b>						
n/a	2" dia column x 27.75"H, adj glide	4 x 4	1	BPBOR1S02RSDGME	150	
n/a	2" dia column cust higher ht, adj glide	4 x 4	1	BPBOR1S02RSHGME	240	
n/a	2" dia column cust lower ht, adj glide	4 x 4	1	BPBOR1S02RSLGME	210	
	n/a	2" dia column x 27.75"H, 2" black caster	4 x 4	1	BPBOR1S02RSDCME	180
	n/a	2" dia column cust higher ht, 2" black caster	4 x 4	1	BPBOR1S02RSHCME	260
	n/a	2" dia column cust lower ht, 2" black caster	4 x 4	1	BPBOR1S02RSLCME	240
	n/a	2" dia column x 27.75"H, 2" silver/black caster	4 x 4	1	BPBOR1S02RSDPME	190
	n/a	2" dia column cust higher ht, 2" silver/black caster	4 x 4	1	BPBOR1S02RSHPME	280
	n/a	2" dia column cust lower ht, 2" silver/black caster	4 x 4	1	BPBOR1S02RSLPME	250

### Bati single base (1)



*	3" column diameter x 27.75"H	6 x 9	1	BPBAT1S3ODSDBME	500
*	3" column diameter cust higher height	6 x 9	1	BPBAT1S3ODSHBME	630
*	3" column diameter cust shorter height	6 x 9	1	BPBAT1S3ODSLBME	570

\*Bati post legs need to be placed at least every 48". 30" max top depth.

Bati is a surface mounted post base that is bolted to the floor, the base can be centered under the top or offset. The cover for the floor plate is only available in black.

Customer shall supply (4) floor anchors or toggles per base -  
-5/16" anchors required in cement

Bati has a 2.5" wire access hole included in the floor plate.

To specify a 1.25" hole in the column use model number **OBPWWMBATI1 - \$50 list per hole**

### Canty end base set (2)



20 x 72	18 x 1 x 2 x 27.75"H	1" x 2" x 6" tabs	2	BFCAN20072SDGME	860
24 x 72	22 x 1 x 2 x 27.75"H	1" x 2" x 6" tabs	2	BFCAN24072SDGME	900
30 x 72	28 x 1 x 2 x 27.75"H	1" x 2" x 6" tabs	2	BFCAN30072SDGME	980
36 x 72	34 x 1 x 2 x 27.75"H	1" x 2" x 6" tabs	2	BFCAN36072SDGME	1,020
42 x 72	40 x 1 x 2 x 27.75"H	1" x 2" x 6" tabs	2	BFCAN42072SDGME	1,070
48 x 72	46 x 1 x 2 x 27.75"H	1" x 2" x 6" tabs	2	BFCAN48072SDGME	1,120

\*Custom shorter or taller heights are available for Canty bases with a minimum quantity of 20 bases of the same size email [service@symphonytables.com](mailto:service@symphonytables.com) for more information and pricing. Wire management holes not available for the Canty bases.

#### (ME) Standard metal powder coat finishes :

Black Wrinkle (BW), Chateau Brown Wrinkle (CB), Flat Black (FB),  
Furniture White (FW), Inner Tone (IT), Light Tone (LT), Medium Tone (MT), Metallic  
Silver (MS)

**\*Borne and Moto post legs need to be placed every 48"**

#### Corner mount plate option (Borne & Moto post bases):













Model number **OBPPCM4V** for a set of 4 post bases - **\$180 list per set**  
Model number **OBPPCM1V** for (1) post base - **\$40 list per base**

#### Wire Management hole option (Borne post bases):

Model number **OBPWWMBOR** for 1.25" dia. wire management holes at the top and bottom of a Borne post base - **\$60 list per base**

# bases

## Moto post

base	max top support	base description	mount plate	qty	model no.	list	
<b>Moto base sets (4)</b>							
	2 x 2 inch	48 x 48, 60 rd	2" sq column x 27.75"H, adj glides	6 x 6	4	BPMOT4S02SSDGME	860
		48 x 48, 60 rd	2" sq column cust higher ht, adj glides	6 x 6	4	BPMOT4S02SSHGME	1,290
		48 x 48, 60 rd	2" sq column cust lower ht, adj glides	6 x 6	4	BPMOT4S02SSLGME	1,090
	48 x 48, 60 rd	2" sq column x 27.75"H, 2" black casters	6 x 6	4	BPMOT4S02SSDCME	950	
		2" sq column cust higher ht, 2" black casters	6 x 6	4	BPMOT4S02SSHCME	1,380	
		2" sq column x cust lower ht, 2" black casters	6 x 6	4	BPMOT4S02SSLCME	1,190	
	48 x 48, 60 rd	2" sq column x 27.75"H, 2" silver/black casters	6 x 6	4	BPMOT4S02SSDPME	1,000	
		2" sq column cust higher ht, 2" silver/black casters	6 x 6	4	BPMOT4S02SSHPME	1,430	
		2" sq column cust lower ht, 2" silver/black casters	6 x 6	4	BPMOT4S02SSLPME	1,230	
<b>2.75 x 2.75 inch</b>							
	48 x 48, 60 rd	2.75" sq column x 27.75"H, adj glides	8 x 8	4	BPMOT4S03SSDGME	990	
		2.75" sq column cust higher ht, adj glides	8 x 8	4	BPMOT4S03SSHGME	1,520	
		2.75" sq column cust lower ht, adj glides	8 x 8	4	BPMOT4S03SSLGME	1,220	
	48 x 48, 60 rd	2.75" sq column x 27.75"H, 2" black casters	8 x 8	4	BPMOT4S03SSDCME	1,090	
		2.75" sq column cust higher ht, 2" black casters	8 x 8	4	BPMOT4S03SSHCME	1,620	
		2.75" sq column cust lower ht, 2" black casters	8 x 8	4	BPMOT4S03SSLCME	1,330	
	48 x 48, 60 rd	2.75" sq column x 27.75"H, 2" silver/black casters	8 x 8	4	BPMOT4S03SSDPME	1,140	
		2.75" sq column cust higher ht, 2" silver/black casters	8 x 8	4	BPMOT4S03SSHPME	1,660	
		2.75" sq column cust lower ht, 2" silver/black casters	8 x 8	4	BPMOT4S03SSLPME	1,380	
<b>Moto single base (1)</b>							
	2 x 2 inch	n/a	2" sq column x 27.75"H, adj glide	6 x 6	1	BPMOT1S02SSDGME	210
		n/a	2" sq column cust higher ht, adj glide	6 x 6	1	BPMOT1S02SSHGME	320
		n/a	2" sq column cust lower ht, adj glide	6 x 6	1	BPMOT1S02SSLGME	280
	n/a	2" sq column x 27.75"H, 2" black caster	6 x 6	1	BPMOT1S02SSDCME	240	
		2" sq column cust higher ht, 2" black caster	6 x 6	1	BPMOT1S02SSHCME	340	
		2" sq column cust lower ht, 2" black caster	6 x 6	1	BPMOT1S02SSLCME	300	
	n/a	2" sq column x 27.75"H, 2" silver/black caster	6 x 6	1	BPMOT1S02SSDPME	250	
		2" sq column cust higher ht, 2" silver/black caster	6 x 6	1	BPMOT1S02SSHPME	350	
		2" sq column cust lower ht, 2" silver/black caster	6 x 6	1	BPMOT1S02SSLPME	310	
<b>2.75 x 2.75 inch</b>							
	n/a	2.75" sq column x 27.75"H, adj glide	8 x 8	1	BPMOT1S03SSDGME	250	
		2.75" sq column cust higher ht, adj glide	8 x 8	1	BPMOT1S03SSHGME	390	
		2.75" sq column cust lower ht, adj glide	8 x 8	1	BPMOT1S03SSLGME	310	
	n/a	2.75" sq column x 27.75"H, 2" black casters	8 x 8	1	BPMOT1S03SSDCME	280	
		2.75" sq column cust higher ht, 2" black casters	8 x 8	1	BPMOT1S03SSHCME	410	
		2.75" sq column cust lower ht, 2" black casters	8 x 8	1	BPMOT1S03SSLCME	330	
	n/a	2.75" sq column x 27.75"H, 2" silver/black casters	8 x 8	1	BPMOT1S03SSDPME	290	
		2.75" sq column cust higher ht, 2" silver/black casters	8 x 8	1	BPMOT1S03SSHPME	420	
		2.75" sq column cust lower ht, 2" silver / black casters	8 x 8	1	BPMOT1S03SSLPME	340	

#### Corner mount plate option (Borne & Moto post bases):

Model number **OBPPCM4V** for a set of 4 post bases - **\$180 list per set**  
Model number **OBPPCM1V** for (1) post base - **\$40 list per base**

#### Wire Management hole option:

Model # **OBWWMOTO-1.5** for 1.5" dia. wire management mouse holes (top & bottom) for one 3" sq base column - **\$60 list per base**  
Model # **OBWWMOTO** - for 1.25" dia. wire management mouse holes (top & bottom) for one 2" sq base column - **\$60 list per base**





# bases

## Moto Frame - no stretcher

For complete custom lower height or custom higher height base model number:

1. Insert height selection:  
**SD** seated height (27.75"H)  
**SC** counter height (34.75"H)  
**SB** bar height (40.75"H)

base	outside base dimensions	top size with 1" overhang on each side	model no.	seated height (27.75"H) list	counter height (34.75"H) list	bar height (40.75"H) list	glides or casters	finish
<b>Moto Frame - no stretcher with glides</b> (2.5 x 2.5 inch tubing)								
	22 x 22	24 x 24	BFMOT24024	GME 1,400	1,500	1,580	adj glides	standard metal
	22 x 34	24 x 36	BFMOT24036	GME 1,430	1,520	1,610	adj glides	standard metal
	22 x 40	24 x 42	BFMOT24042	GME 1,440	1,530	1,630	adj glides	standard metal
	22 x 46	24 x 48	BFMOT24048	GME 1,490	1,600	1,670	adj glides	standard metal
	22 x 58	24 x 60	BFMOT24060	GME 1,500	1,610	1,690	adj glides	standard metal
	22 x 70	24 x 72	BFMOT24072	GME 1,540	1,640	1,730	adj glides	standard metal
	28 x 28	30 x 30	BFMOT30030	GME 1,430	1,520	1,610	adj glides	standard metal
	28 x 34	30 x 36	BFMOT30036	GME 1,440	1,530	1,620	adj glides	standard metal
	28 x 40	30 x 42	BFMOT30042	GME 1,450	1,540	1,630	adj glides	standard metal
	28 x 46	30 x 48	BFMOT30048	GME 1,460	1,550	1,640	adj glides	standard metal
28 x 58	30 x 60	BFMOT30060	GME 1,520	1,620	1,690	adj glides	standard metal	
28 x 70	30 x 72	BFMOT30072	GME 1,550	1,650	1,740	adj glides	standard metal	
34 x 34	36 x 36	BFMOT36036	GME 1,490	1,580	1,660	adj glides	standard metal	
34 x 40	36 x 42	BFMOT36042	GME 1,500	1,600	1,670	adj glides	standard metal	
34 x 46	36 x 48	BFMOT36048	GME 1,510	1,610	1,680	adj glides	standard metal	
34 x 58	36 x 60	BFMOT36060	GME 1,570	1,660	1,750	adj glides	standard metal	
34 x 70	36 x 72	BFMOT36072	GME 1,610	1,690	1,780	adj glides	standard metal	
40 x 40	42 x 42	BFMOT42042	GME 1,510	1,610	1,680	adj glides	standard metal	
40 x 46	42 x 48	BFMOT42048	GME 1,520	1,620	1,690	adj glides	standard metal	
40 x 58	42 x 60	BFMOT42060	GME 1,550	1,650	1,740	adj glides	standard metal	
40 x 70	42 x 72	BFMOT42072	GME 1,580	1,670	1,760	adj glides	standard metal	
46 x 46	48 x 48	BFMOT48048	GME 1,530	1,630	1,720	adj glides	standard metal	
46 x 58	48 x 60	BFMOT48060	GME 1,600	1,680	1,770	adj glides	standard metal	
46 x 70	48 x 72	BFMOT48060	GME 1,630	1,730	1,800	adj glides	standard metal	
<b>Moto Frame - no stretcher with 3.5"H industrial black locking casters</b> (2.5 x 2.5 inch tubing)								
	22 x 22	24 x 24	BFMOT24024	CME 1,640	1,740	1,830	casters	standard metal
	22 x 34	24 x 36	BFMOT24036	CME 1,670	1,760	1,850	casters	standard metal
	22 x 40	24 x 42	BFMOT24042	CME 1,680	1,770	1,870	casters	standard metal
	22 x 46	24 x 48	BFMOT24048	CME 1,730	1,840	1,910	casters	standard metal
	22 x 58	24 x 60	BFMOT24060	CME 1,740	1,850	1,940	casters	standard metal
	22 x 70	24 x 72	BFMOT24072	CME 1,780	1,880	1,970	casters	standard metal
	28 x 28	30 x 30	BFMOT30030	CME 1,670	1,760	1,850	casters	standard metal
	28 x 34	30 x 36	BFMOT30036	CME 1,680	1,770	1,860	casters	standard metal
	28 x 40	30 x 42	BFMOT30042	CME 1,690	1,780	1,870	casters	standard metal
	28 x 46	30 x 48	BFMOT30048	CME 1,710	1,790	1,880	casters	standard metal
28 x 58	30 x 60	BFMOT30060	CME 1,760	1,860	1,940	casters	standard metal	
28 x 70	30 x 72	BFMOT30072	CME 1,790	1,890	1,980	casters	standard metal	
34 x 34	36 x 36	BFMOT36036	CME 1,730	1,830	1,900	casters	standard metal	
34 x 40	36 x 42	BFMOT36042	CME 1,740	1,840	1,910	casters	standard metal	
34 x 46	36 x 48	BFMOT36048	CME 1,750	1,850	1,930	casters	standard metal	
34 x 58	36 x 60	BFMOT36060	CME 1,820	1,900	1,990	casters	standard metal	
34 x 70	36 x 72	BFMOT36072	CME 1,850	1,940	2,020	casters	standard metal	
40 x 40	42 x 42	BFMOT42042	CME 1,750	1,850	1,930	casters	standard metal	
40 x 46	42 x 48	BFMOT42048	CME 1,760	1,860	1,940	casters	standard metal	
40 x 58	42 x 60	BFMOT42060	CME 1,790	1,890	1,980	casters	standard metal	
40 x 70	42 x 72	BFMOT42072	CME 1,830	1,910	2,000	casters	standard metal	
46 x 46	48 x 48	BFMOT48048	CME 1,770	1,870	1,960	casters	standard metal	
46 x 58	48 x 60	BFMOT48060	CME 1,840	1,930	2,010	casters	standard metal	
46 x 70	48 x 72	BFMOT48060	CME 1,870	1,970	2,050	casters	standard metal	

**(ME) Standard metal powder coat finishes :**  
 Black Wrinkle (BW), Chateau Brown Wrinkle (CB), Flat Black (FB), Furniture White (FW), Inner Tone (IT), Light Tone (LT), Medium Tone (MT), Inner Tone (IT), Light Tone (LT), Medium Tone (MT), Metallic Silver (MS).





**Moto magnetic wire manager for a rectangular or square column:**  
 Model number **OBWMM18** - \$120 list per base  
 (wire management holes in the column are not available for the Moto Frame bases with 2.5 x 2.5 inch tubing)

# bases

## Moto II Frame - no stretcher

For complete custom lower height or custom higher height base model number:

1. Insert height selection:  
**SD** seated height (27.75"H)  
**SC** counter height (34.75"H)  
**SB** bar height (40.75"H)

base	outside base dimensions	top size with 1.5" overhang on each side	model no.	seated height (27.75"H) list	counter height (34.75"H) list	bar height (40.75"H) list	glides or casters	finish
<b>Moto II Frame - no stretcher with glides</b> (2 x 2 inch tubing)								
	21 x 21	24 x 24	BFMO224024	GME 1,190	1,290	1,370	adj glides	standard metal
	21 x 27	24 x 30	BFMO224030	GME 1,210	1,310	1,390	adj glides	standard metal
	21 x 33	24 x 36	BFMO224036	GME 1,220	1,330	1,400	adj glides	standard metal
	21 x 39	24 x 42	BFMO224042	GME 1,240	1,340	1,410	adj glides	standard metal
	21 x 45	24 x 48	BFMO224048	GME 1,270	1,370	1,440	adj glides	standard metal
	21 x 51	24 x 54	BFMO224054	GME 1,280	1,380	1,460	adj glides	standard metal
	21 x 57	24 x 60	BFMO224060	GME 1,290	1,390	1,470	adj glides	standard metal
	21 x 63	24 x 66	BFMO224066	GME 1,300	1,410	1,480	adj glides	standard metal
	21 x 69	24 x 72	BFMO224072	GME 1,320	1,430	1,500	adj glides	standard metal
	27 x 27	30 x 30	BFMO230030	GME 1,230	1,340	1,410	adj glides	standard metal
27 x 33	30 x 36	BFMO230036	GME 1,240	1,350	1,420	adj glides	standard metal	
27 x 39	30 x 42	BFMO230042	GME 1,260	1,360	1,440	adj glides	standard metal	
27 x 45	30 x 48	BFMO230048	GME 1,290	1,390	1,470	adj glides	standard metal	
27 x 51	30 x 54	BFMO230054	GME 1,310	1,410	1,480	adj glides	standard metal	
27 x 57	30 x 60	BFMO230060	GME 1,320	1,430	1,500	adj glides	standard metal	
27 x 63	30 x 66	BFMO230066	GME 1,340	1,450	1,520	adj glides	standard metal	
27 x 69	30 x 72	BFMO230072	GME 1,350	1,460	1,530	adj glides	standard metal	
33 x 33	36 x 36	BFMO236036	GME 1,280	1,390	1,460	adj glides	standard metal	
33 x 39	36 x 42	BFMO236042	GME 1,300	1,410	1,470	adj glides	standard metal	
33 x 45	36 x 48	BFMO236048	GME 1,310	1,420	1,490	adj glides	standard metal	
33 x 57	36 x 60	BFMO236060	GME 1,360	1,460	1,530	adj glides	standard metal	
33 x 63	36 x 66	BFMO236066	GME 1,370	1,480	1,550	adj glides	standard metal	
33 x 69	36 x 72	BFMO236072	GME 1,390	1,490	1,570	adj glides	standard metal	
<b>Moto II Frame - no stretcher with 3.5" industrial black locking casters</b> (2 x 2 inch tubing)								
	21 x 21	24 x 24	BFMO224024	CME 1,610	1,710	1,790	casters	standard metal
	21 x 27	24 x 30	BFMO224030	CME 1,630	1,730	1,810	casters	standard metal
	21 x 33	24 x 36	BFMO224036	CME 1,640	1,750	1,820	casters	standard metal
	21 x 39	24 x 42	BFMO224042	CME 1,660	1,760	1,830	casters	standard metal
	21 x 45	24 x 48	BFMO224048	CME 1,690	1,790	1,860	casters	standard metal
	21 x 51	24 x 54	BFMO224054	CME 1,700	1,800	1,880	casters	standard metal
	21 x 57	24 x 60	BFMO224060	CME 1,710	1,810	1,890	casters	standard metal
	21 x 63	24 x 66	BFMO224066	CME 1,720	1,830	1,900	casters	standard metal
	21 x 69	24 x 72	BFMO224072	CME 1,740	1,850	1,920	casters	standard metal
	27 x 27	30 x 30	BFMO230030	CME 1,650	1,760	1,830	casters	standard metal
27 x 33	30 x 36	BFMO230036	CME 1,660	1,770	1,840	casters	standard metal	
27 x 39	30 x 42	BFMO230042	CME 1,680	1,780	1,860	casters	standard metal	
27 x 45	30 x 48	BFMO230048	CME 1,710	1,810	1,890	casters	standard metal	
27 x 51	30 x 54	BFMO230054	CME 1,730	1,830	1,900	casters	standard metal	
27 x 57	30 x 60	BFMO230060	CME 1,740	1,850	1,920	casters	standard metal	
27 x 63	30 x 66	BFMO230066	CME 1,760	1,870	1,940	casters	standard metal	
27 x 69	30 x 72	BFMO230072	CME 1,770	1,880	1,950	casters	standard metal	
33 x 33	36 x 36	BFMO236036	CME 1,700	1,810	1,880	casters	standard metal	
33 x 39	36 x 42	BFMO236042	CME 1,720	1,830	1,890	casters	standard metal	
33 x 45	36 x 48	BFMO236048	CME 1,730	1,840	1,910	casters	standard metal	
33 x 57	36 x 60	BFMO236060	CME 1,780	1,880	1,950	casters	standard metal	
33 x 63	36 x 66	BFMO236066	CME 1,790	1,900	1,970	casters	standard metal	
33 x 69	36 x 72	BFMO236072	CME 1,810	1,910	1,990	casters	standard metal	

**(ME) Standard metal powder coat finishes :**  
 Black Wrinkle (BW), Chateau Brown Wrinkle (CB), Flat Black (FB), Furniture White (FW), Inner Tone (IT), Light Tone (LT), Medium Tone (MT), Inner Tone (IT), Light Tone (LT), Medium Tone (MT), Metallic Silver (MS).



**Wire Management hole option:**  
 Model number **OBWMMOTO** for 1.25" dia. wire management holes at the top and bottom of a Moto II Frame base - \$60 list per base  
 (not available on the Moto Frame 2.5 x 2.5 inch tubing base)

# bases

## Moto Frame - single stretcher

For complete custom lower height or custom higher height base model number:

1. Insert height selection:  
**SD** seated height (27.75"H)  
**SC** counter height (34.75"H)  
**SB** bar height (40.75"H)

base	outside base dimensions	top size with 1.5" overhang on each side	model no.	seated height (27.75"H) list	counter height (34.75"H) list	bar height (40.75"H) list	glides or casters	finish	
<b>Moto II Frame - single stretcher with glides (2 x 2 inch tubing)</b>									
	21 x 27	24 x 30	BFMO324030 ___ GME	1,590	1,690	1,760	adj glides	standard metal	
	21 x 33	24 x 36	BFMO324036 ___ GME	1,600	1,710	1,780	adj glides	standard metal	
	21 x 39	24 x 42	BFMO324042 ___ GME	1,620	1,730	1,800	adj glides	standard metal	
	21 x 45	24 x 48	BFMO324048 ___ GME	1,660	1,770	1,840	adj glides	standard metal	
	21 x 51	24 x 54	BFMO324054 ___ GME	1,700	1,810	1,880	adj glides	standard metal	
	21 x 57	24 x 60	BFMO324060 ___ GME	1,710	1,810	1,890	adj glides	standard metal	
	21 x 63	24 x 66	BFMO324066 ___ GME	1,730	1,840	1,910	adj glides	standard metal	
	21 x 69	24 x 72	BFMO324072 ___ GME	1,750	1,860	1,930	adj glides	standard metal	
	21 x 81	24 x 84	BFMO324084 ___ GME	1,940	2,040	2,120	adj glides	standard metal	
	21 x 93	24 x 96	BFMO324096 ___ GME	2,040	2,140	2,210	adj glides	standard metal	
	27 x 33	30 x 36	BFMO330036 ___ GME	1,640	1,750	1,820	adj glides	standard metal	
	27 x 39	30 x 42	BFMO330042 ___ GME	1,660	1,760	1,840	adj glides	standard metal	
	27 x 45	30 x 48	BFMO330048 ___ GME	1,700	1,800	1,870	adj glides	standard metal	
	27 x 51	30 x 54	BFMO330054 ___ GME	1,730	1,840	1,910	adj glides	standard metal	
	27 x 57	30 x 60	BFMO330060 ___ GME	1,750	1,860	1,930	adj glides	standard metal	
	27 x 63	30 x 66	BFMO330066 ___ GME	1,780	1,890	1,960	adj glides	standard metal	
	27 x 69	30 x 72	BFMO330072 ___ GME	1,790	1,900	1,970	adj glides	standard metal	
	27 x 81	30 x 84	BFMO330084 ___ GME	1,980	2,090	2,160	adj glides	standard metal	
	27 x 93	30 x 96	BFMO330096 ___ GME	2,080	2,180	2,260	adj glides	standard metal	
		33 x 39	36 x 42	BFMO336042 ___ GME	1,710	1,820	1,880	adj glides	standard metal
33 x 45		36 x 48	BFMO336048 ___ GME	1,730	1,840	1,910	adj glides	standard metal	
33 x 57		36 x 60	BFMO336060 ___ GME	1,800	1,900	1,980	adj glides	standard metal	
33 x 63		36 x 66	BFMO336066 ___ GME	1,820	1,930	2,000	adj glides	standard metal	
33 x 69		36 x 72	BFMO336072 ___ GME	1,840	1,940	2,020	adj glides	standard metal	
33 x 81		36 x 84	BFMO336084 ___ GME	2,030	2,140	2,210	adj glides	standard metal	
33 x 93		36 x 96	BFMO336096 ___ GME	2,120	2,230	2,300	adj glides	standard metal	
<b>Moto II Frame - single stretcher with 3.5" industrial black locking casters (2 x 2 inch tubing)</b>									
		21 x 27	24 x 30	BFMO324030 ___ CME	1,980	2,080	2,160	casters	standard metal
		21 x 33	24 x 36	BFMO324036 ___ CME	2,000	2,100	2,180	casters	standard metal
	21 x 39	24 x 42	BFMO324042 ___ CME	2,020	2,120	2,190	casters	standard metal	
	21 x 45	24 x 48	BFMO324048 ___ CME	2,060	2,160	2,230	casters	standard metal	
	21 x 51	24 x 54	BFMO324054 ___ CME	2,090	2,190	2,260	casters	standard metal	
	21 x 57	24 x 60	BFMO324060 ___ CME	2,100	2,210	2,280	casters	standard metal	
	21 x 63	24 x 66	BFMO324066 ___ CME	2,120	2,230	2,300	casters	standard metal	
	21 x 69	24 x 72	BFMO324072 ___ CME	2,150	2,250	2,320	casters	standard metal	
	21 x 81	24 x 84	BFMO324084 ___ CME	2,330	2,440	2,510	casters	standard metal	
	21 x 93	24 x 96	BFMO324096 ___ CME	2,430	2,540	2,610	casters	standard metal	
	27 x 33	30 x 36	BFMO330036 ___ CME	2,030	2,140	2,210	casters	standard metal	
	27 x 39	30 x 42	BFMO330042 ___ CME	2,050	2,160	2,230	casters	standard metal	
	27 x 45	30 x 48	BFMO330048 ___ CME	2,090	2,190	2,260	casters	standard metal	
	27 x 51	30 x 54	BFMO330054 ___ CME	2,130	2,230	2,300	casters	standard metal	
	27 x 57	30 x 60	BFMO330060 ___ CME	2,150	2,250	2,330	casters	standard metal	
	27 x 63	30 x 66	BFMO330066 ___ CME	2,170	2,280	2,350	casters	standard metal	
	27 x 69	30 x 72	BFMO330072 ___ CME	2,190	2,290	2,360	casters	standard metal	
	27 x 81	30 x 84	BFMO330084 ___ CME	2,370	2,480	2,550	casters	standard metal	
	27 x 93	30 x 96	BFMO330096 ___ CME	2,470	2,580	2,650	casters	standard metal	
		33 x 39	36 x 42	BFMO336042 ___ CME	2,100	2,210	2,280	casters	standard metal
33 x 45		36 x 48	BFMO336048 ___ CME	2,120	2,230	2,300	casters	standard metal	
33 x 57		36 x 60	BFMO336060 ___ CME	2,190	2,300	2,370	casters	standard metal	
33 x 63		36 x 66	BFMO336066 ___ CME	2,210	2,320	2,390	casters	standard metal	
33 x 69		36 x 72	BFMO336072 ___ CME	2,230	2,340	2,410	casters	standard metal	
33 x 81		36 x 84	BFMO336084 ___ CME	2,420	2,530	2,600	casters	standard metal	
33 x 93		36 x 96	BFMO336096 ___ CME	2,510	2,620	2,690	casters	standard metal	

**(ME) Standard metal powder coat finishes :**  
 Black Wrinkle (BW), Chateau Brown Wrinkle (CB), Flat Black (FB), Furniture White (FW), Inner Tone (IT), Light Tone (LT), Medium Tone (MT), Metallic Silver (MS).



**Wire Management hole option:**  
 Model number **OBWMHMOTO** for 1.25" dia. wire management holes at the top and bottom of a Moto II Frame base column (1) - **\$60 list per base**

# bases

## Moto II Frame - dual stretcher

For complete custom lower height or custom higher height base model number:

1. Insert height selection:  
**SD** seated height (27.75"H)  
**SC** counter height (34.75"H)  
**SB** bar height (40.75"H)

base	outside base dimensions	top size with 1.5" overhang on each side	model no.	seated height (27.75"H) list	counter height (34.75"H) list	bar height (40.75"H) list	glides or casters	finish	
<b>Moto II Frame - dual stretcher with glides (2 x 2 inch tubing)</b>									
	39 x 39	42 x 42	BFMO342042 ___ GME	2,130	2,210	2,290	adj glides	standard metal	
	39 x 45	42 x 48	BFMO342048 ___ GME	2,150	2,240	2,310	adj glides	standard metal	
	39 x 51	42 x 54	BFMO342054 ___ GME	2,190	2,280	2,350	adj glides	standard metal	
	39 x 57	42 x 60	BFMO342060 ___ GME	2,210	2,290	2,370	adj glides	standard metal	
	39 x 63	42 x 66	BFMO342066 ___ GME	2,240	2,330	2,400	adj glides	standard metal	
	39 x 69	42 x 72	BFMO342072 ___ GME	2,290	2,370	2,450	adj glides	standard metal	
	39 x 81	42 x 84	BFMO342084 ___ GME	2,330	2,410	2,490	adj glides	standard metal	
	39 x 93	42 x 96	BFMO342096 ___ GME	2,610	2,700	2,770	adj glides	standard metal	
		45 x 45	48 x 48	BFMO348048 ___ GME	2,170	2,250	2,330	adj glides	standard metal
		45 x 57	48 x 60	BFMO348060 ___ GME	2,250	2,340	2,410	adj glides	standard metal
45 x 63		48 x 66	BFMO348066 ___ GME	2,280	2,360	2,440	adj glides	standard metal	
45 x 69		48 x 72	BFMO348072 ___ GME	2,310	2,390	2,470	adj glides	standard metal	
45 x 81		48 x 84	BFMO348084 ___ GME	2,340	2,420	2,500	adj glides	standard metal	
45 x 93		48 x 96	BFMO348096 ___ GME	2,630	2,720	2,790	adj glides	standard metal	
<b>Moto III Frame - dual stretcher with 3.5" industrial black locking casters (2 x 2 inch tubing)</b>									
		39 x 39	42 x 42	BFMO342042 ___ CME	2,520	2,610	2,690	casters	standard metal
		39 x 45	42 x 48	BFMO342048 ___ CME	2,540	2,630	2,700	casters	standard metal
		39 x 51	42 x 54	BFMO342054 ___ CME	2,590	2,670	2,750	casters	standard metal
	39 x 57	42 x 60	BFMO342060 ___ CME	2,600	2,690	2,760	casters	standard metal	
	39 x 63	42 x 66	BFMO342066 ___ CME	2,640	2,720	2,800	casters	standard metal	
	39 x 69	42 x 72	BFMO342072 ___ CME	2,680	2,770	2,840	casters	standard metal	
	39 x 81	42 x 84	BFMO342084 ___ CME	2,720	2,810	2,880	casters	standard metal	
	39 x 93	42 x 96	BFMO342096 ___ CME	3,000	3,090	3,170	casters	standard metal	
		45 x 45	48 x 48	BFMO348048 ___ CME	2,560	2,650	2,720	casters	standard metal
		45 x 57	48 x 60	BFMO348060 ___ CME	2,640	2,730	2,810	casters	standard metal
45 x 63		48 x 66	BFMO348066 ___ CME	2,670	2,760	2,840	casters	standard metal	
45 x 69		48 x 72	BFMO348072 ___ CME	2,700	2,790	2,860	casters	standard metal	
45 x 81		48 x 84	BFMO348084 ___ CME	2,730	2,820	2,890	casters	standard metal	
45 x 93		48 x 96	BFMO348096 ___ CME	3,020	3,110	3,180	casters	standard metal	

**(ME) Standard metal powder coat finishes :**  
 Black Wrinkle (BW), Chateau Brown Wrinkle (CB), Flat Black (FB), Furniture White (FW), Inner Tone (IT), Light Tone (LT), Medium Tone (MT), Metallic Silver (MS).

**Wire Management hole option:**  
 Model number **OBWMHMOTO** for 1.25" dia. wire management holes at the top and bottom of a Moto II Frame base column (1) - **\$60 list per base**

# bases

## post

### Krauss

base	angle	base description	mount plate	Qty	model no.	list for (1) post base
Krauss	22 degrees	2" x 2" x 16.75"H angled column	6 x 6	1	BPKRA12022SOGME	260
	22 degrees	2" x 2" x 27.75"H angled column	6 x 6	1	BPKRA12022SDGME	260
	22 degrees	2.75" x 2.75" x 16.75"H angled column	8 x 8	1	BPKRA13022SOGME	290
	22 degrees	2.75" x 2.75" x 27.75"H angled column	8 x 8	1	BPKRA13022SDGME	290
	30 degrees	2.75" x 2.75" x 27.75"H angled column*	8 x 8	1	BPKRA13030SDGME	290

**\*2.75" 30 degree angle base shall be used with 42" or 48" deep rectangle tops**

**(ME) Standard metal powder coat finishes :**  
 Black Wrinkle (BW), Chateau Brown Wrinkle (CB), Flat Black (FB),  
 Furniture White (FW), Inner Tone (IT), Light Tone (LT), Medium Tone (MT), Metallic Silver (MS).

\* The above pricing for the **Krauss series angled post base** is for a single base. Due to the versatility of this base, please email [service@symphonytables.com](mailto:service@symphonytables.com) to verify how many bases you will need and quantity of bases required to support your top.

Note that the height of the base as well as the degree angle of the base will determine the top size that it will support. We encourage you to contact our support team to obtain a drawing to verify that the bases will fit under the intended top size.

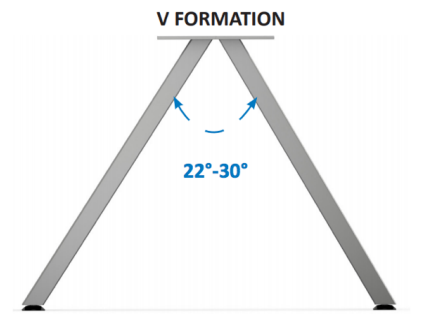

Picture above shows two column legs in V Formation. Multiple variations can be used with this column. Pricing is done per column.



rectangle table with (4) Krauss 2.00 x 2.00 legs



rectangle table with (4) Krauss 2.75 x 2.75 legs

# bases

## post

### Krauss

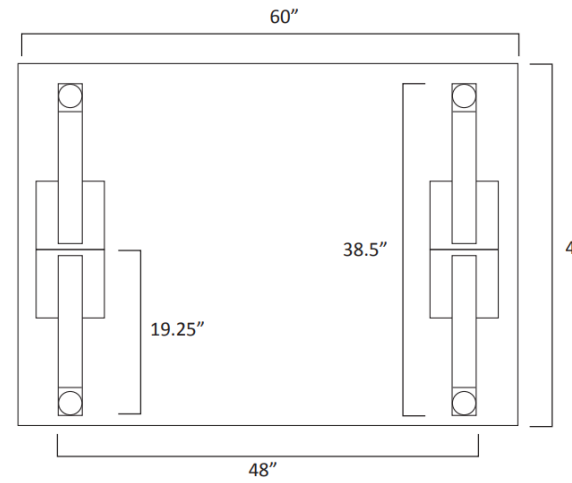

Suggested Max Top size of 42" x 60"

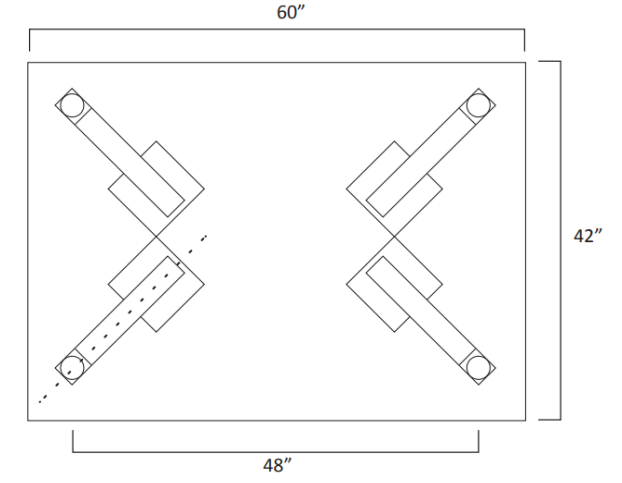

Suggested Max Top size of 42" x 60"

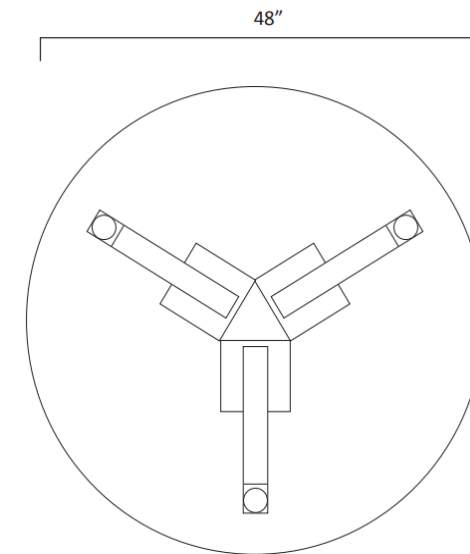

Suggested Max Top size of 48" dia.

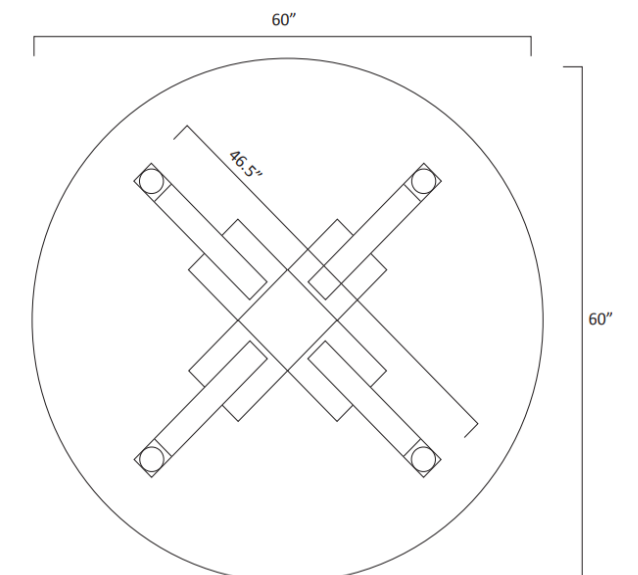

Suggested Max Top size of 60" dia.

# bases

## post

### Pyra

base	base description	base height	qty	model no.	list
Pyra	tapered angled post base with wire management in base, adj glides	27.75	4	BPPYR4STASDGME	1,030
	tapered angled post base with wire management in base, adj glides	34.75	4	BPPYR4STASCGME	1,170
	tapered angled post base with wire management in base, adj glides	40.75	4	BPPYR4STASBGME	1,320

**reference illustrations to view the minimum and maximum top sizes for each base overall base height (27.75"H, 34.75"H, 40.75"H bases)**  
**weight capacity is 200 lbs including the top for a set of 4 bases**

**(ME) Standard metal powder coat finishes :**  
 Flat Black (FB), Furniture White (FW), Inner Tone (IT), Light Tone (LT), Medium Tone (MT), Metallic Silver (MS).

**Note that the maximum table top diameter that 4 bases will hold is 60" round**

ILLUSTRATION A

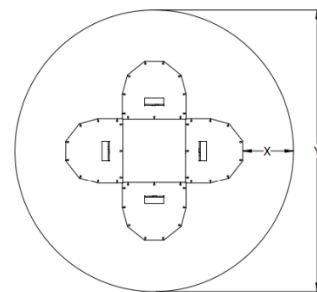

**ROUND TOP CENTER CONFIGURATION**

**42" H legs**    **36" H legs**    **29" H legs**  
 X: 8.75"    X: 6.8125"    X: 4.75"  
 Y: 48" (minimum table top size)    Y: 46" (minimum table top size)    Y: 40" (minimum table top size)

ILLUSTRATION B

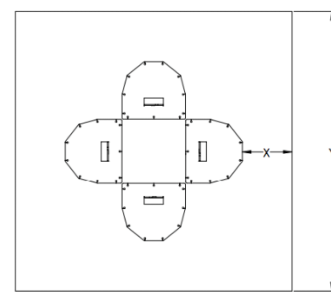

**SQUARE TOP CENTER CONFIGURATION**

**42"**    **36"**    **29"**  
 X: 8.75"    X: 6.8125"    X: 4.75"  
 Y: 48" (minimum table top size)    Y: 46" (minimum table top size)    Y: 40" (minimum table top size)



ILLUSTRATION C

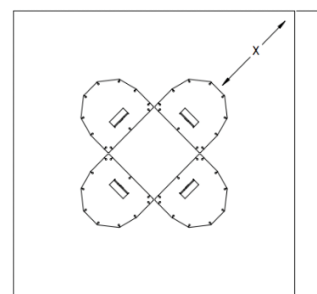

**SQUARE TOP CORNER CONFIGURATION**

**42" H legs**    **36" H legs**    **29" H legs**  
 X: 11.5"    X: 9.5"    X: 7.375"  
 Y: 38" (minimum table top size)    Y: 36" (minimum table top size)    Y: 32" (minimum table top size)

Maximum tabletop diameter is 60".

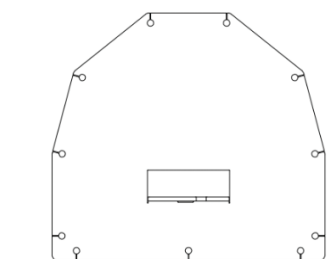

**MOUNTING PLATE**

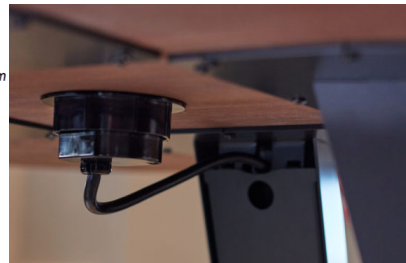

power/data  
+ wire management

\* top size range: 42 x 42 up to 60 x 60

# power supply location chart

## long ways on top

Our main focus is integrating technology into tables for learning and meeting environments. We invite you to email [service@symphonytables.com](mailto:service@symphonytables.com) for help with specifying your project. For the additional resources, please visit [www.symphonytables.com](http://www.symphonytables.com).

**Please specify the power supply location cut out on your PO:**

POWER MODULE LOCATIONS FOR UNITS RUNNING LONG WAYS ON THE TOP:

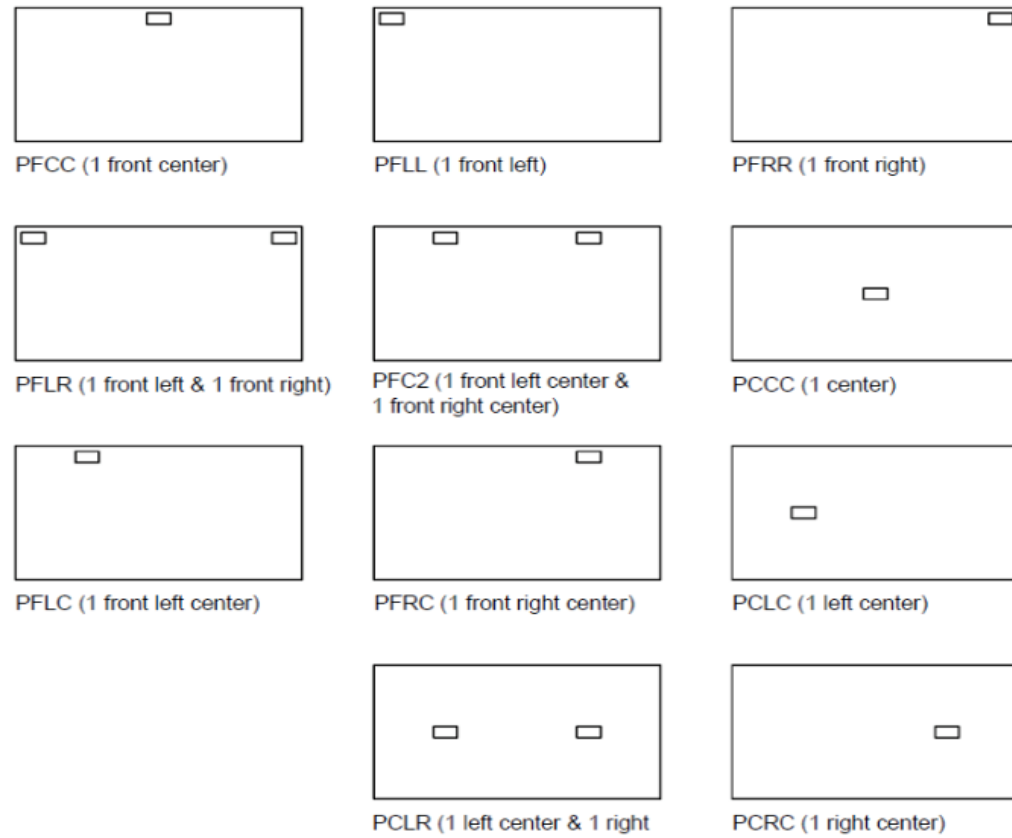

**Note that power supplies cannot be placed over metal base plates, contact [service@symphonytables.com](mailto:service@symphonytables.com) to ensure that the power supply location will work with your base placement and all of the other options / accessories specified on the table.**

# power supply location chart

## short ways on top

**Please specify the power supply location cut out on your PO:**



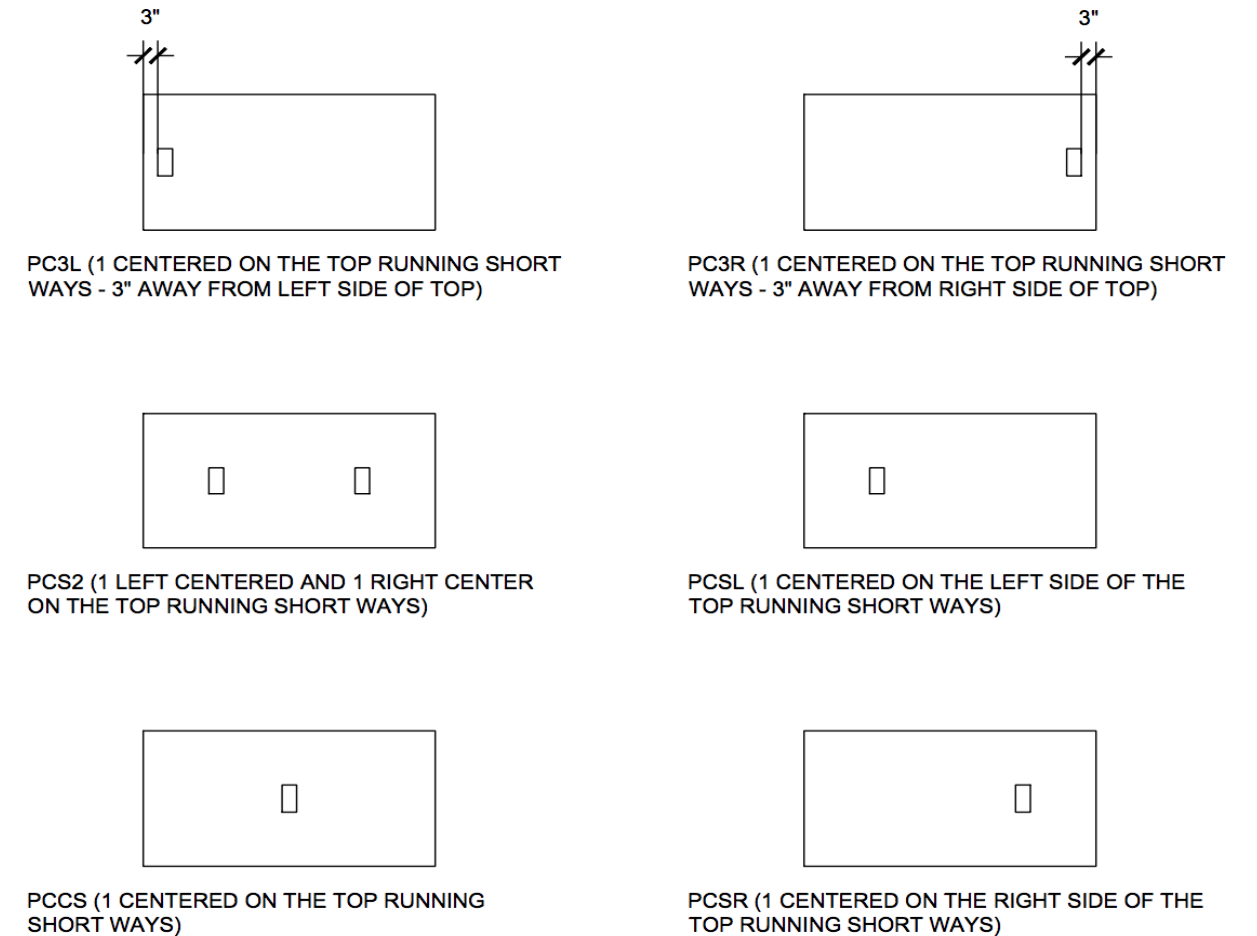

POWER MODULE LOCATIONS FOR UNITS RUNNING SHORT WAYS ON THE TOP:



**Note that power supplies cannot be placed over metal base plates, contact [service@symphonytables.com](mailto:service@symphonytables.com) to ensure that the power supply location will work with your base placement and all of the other options / accessories specified on the table.**

# power/data modules

Ariba in surface

module	description	# of ports	model no.	cord length	finish code	list
Ariba in surface single-sided unit						
	2 port 3"D x 4.5"W table top cut out, specify location cut out shall have 1/4" radius corners	2	OPPARI2P0A0D06GW	6 ft.	GW	330
			OPPARI2P0A0D06GB	6 ft.	GB	330
			OPPARI2P0A0D06GS	6 ft.	GS	330
			OPPARI2P0A0D10GW	10 ft.	GW	350
			OPPARI2P0A0D10GB	10 ft.	GB	350
			OPPARI2P0A0D10GS	10 ft.	GS	350
	1 power, 1 USB-4C 3"D x 4.5"W table top cut out, specify location cut out shall have 1/4" radius corners	2	OPPARI1P4C0D06GW	6 ft.	GW	470
			OPPARI1P4C0D06GB	6 ft.	GB	470
			OPPARI1P4C0D06GS	6 ft.	GS	470
			OPPARI1P4C0D10GW	10 ft.	GW	490
			OPPARI1P4C0D10GB	10 ft.	GB	490
			OPPARI1P4C0D10GS	10 ft.	GS	490
	1 power, 1 USB-A+C 3"D x 4.5"W table top cut out, specify location cut out shall have 1/4" radius corners	2	OPPARI1PAC0D06GW	6 ft.	GW	530
			OPPARI1PAC0D06GB	6 ft.	GB	530
			OPPARI1PAC0D06GS	6 ft.	GS	530
			OPPARI1PAC0D10GW	10 ft.	GW	550
			OPPARI1PAC0D10GB	10 ft.	GB	550
			OPPARI1PAC0D10GS	10 ft.	GS	550
	1 power, 1 dual C+A 3"D x 4.5"W table top cut out, specify location cut out shall have 1/4" radius corners	2	OPPARI1P2C1A06GW	6 ft.	GW	470
			OPPARI1P2C1A06GB	6 ft.	GB	470
			OPPARI1P2C1A06GS	6 ft.	GS	470
			OPPARI1P2C1A10GW	10 ft.	GW	490
			OPPARI1P2C1A10GB	10 ft.	GB	490
			OPPARI1P2C1A10GS	10 ft.	GS	490
	3 power, 1 open data 3"D x 6-15/16"W table top cut out, specify location cut out shall have 3/8" radius corners	4	OPPARI3P0A1D06GW	6 ft.	GW	410
			OPPARI3P0A1D06GB	6 ft.	GB	410
			OPPARI3P0A1D06GS	6 ft.	GS	410
			OPPARI3P0A1D10GW	10 ft.	GW	430
			OPPARI3P0A1D10GB	10 ft.	GB	430
			OPPARI3P0A1D10GS	10 ft.	GS	430
	3 power, 1 USB-A+C 3"D x 6-15/16"W table top cut out, specify location cut out shall have 3/8" radius corners	4	OPPARI3PAC0D06GW	6 ft.	GW	530
			OPPARI3PAC0D06GB	6 ft.	GB	530
			OPPARI3PAC0D06GS	6 ft.	GS	530
			OPPARI3PAC0D10GW	10 ft.	GW	550
			OPPARI3PAC0D10GB	10 ft.	GB	550
			OPPARI3PAC0D10GS	10 ft.	GS	550
2 power, 1 HDMI, 1 USB-A+C 3"D x 6-15/16"W table top cut out, specify location cut out shall have 3/8" radius corners	4	OPPARI2P1HAC06GW	6 ft.	GW	550	
		OPPARI2P1HAC06GB	6 ft.	GB	550	
		OPPARI2P1HAC06GS	6 ft.	GS	550	
		OPPARI2P1HAC10GW	10 ft.	GW	570	
		OPPARI2P1HAC10GB	10 ft.	GB	570	
		OPPARI2P1HAC10GS	10 ft.	GS	570	
2 power, 1 USB-A+C, 1 open data 3"D x 6-15/16"W table top cut out, specify location cut out shall have 3/8" radius corners	4	OPPARI2PAC1D06GW	6 ft.	GW	500	
		OPPARI2PAC1D06GB	6 ft.	GB	500	
		OPPARI2PAC1D06GS	6 ft.	GS	500	
		OPPARI2PAC1D10GW	10 ft.	GW	520	
		OPPARI2PAC1D10GB	10 ft.	GB	520	
		OPPARI2PAC1D10GS	10 ft.	GS	520	

Ariba 2 port in surface cut out information:

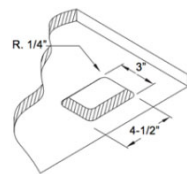

Ariba 4 port in surface cut out information:

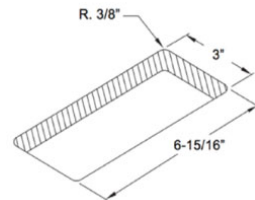

ARIBA SERIES FINISH CODE LEGEND:



GW - Gloss white finish, white cord



GB - Gloss black finish, black cord







GS - Gloss storm finish, black cord

# power/data modules

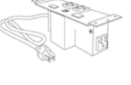
Asti and Asti II in surface

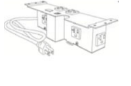
Asti undermount

module	description	model no.	grommet finish	module finish	list		
Asti in surface							
	2 power, 1 convenience outlet below the worksurface, 108 inch cord 2 open data ports for RJ45 Cat 6 data (data jacks not included) 3"D x 5.25"W table top cut out size - specify placement	OPPAST2P0UDR91SB	silver	silver	470		
		OPPAST2P0UDR91BB	black	black	470		
		OPPAST2P0UDR91WW	white	silver	470		
		OPPAST2P0UDR91AB	brushed aluminum	black	560		
		OPPAST2P0UDR91ST	stainless steel	black	560		
		OPPAST2P1UDR91SB	silver	silver	670		
	2 power, 1 dual charging USB-A, 1 convenience outlet below the worksurface, 108 inch cord 2 open data ports for RJ45 Cat 6 data (data jacks not included) 3"D x 5.25"W table top cut out size - specify placement	OPPAST2P1UDR91BB	black	black	670		
		OPPAST2P1UDR91WW	white	silver	670		
		OPPAST2P1UDR91AB	brushed aluminum	black	760		
		OPPAST2P1UDR91ST	stainless steel	black	760		
		Asti II in surface					
			2 power at the surface, 3 convenience outlets below the worksurface, 108 inch cord 2 open data ports for RJ45 Cat 6 data (data jacks not included) 3"D x 5.25"W table top cut out size - specify placement	OPPAS22P0UDR93SB	silver	silver	560
OPPAS22P0UDR93BB	black			black	560		
OPPAS22P0UDR93WW	white			white	560		
OPPAS22P0UDR93AB	brushed aluminum			black	650		
OPPAS22P0UDR93ST	stainless steel			black	650		
	2 power at the surface, 1 dual charging USB-A 3 convenience outlets below the worksurface, 108 inch cord 1 open data port for an RJ45 Cat 6 data (data jack not included) 3"D x 5.25"W table top cut out size - specify placement			OPPAS22P1UDR93SB	silver	silver	770
		OPPAS22P1UDR93BB	black	black	770		
		OPPAS22P1UDR93WW	white	white	770		
		OPPAS22P1UDR93AB	brushed aluminum	black	860		
		OPPAS22P1UDR93ST	stainless steel	black	860		
		Asti undermount					
	2 power, 1 convenience outlet under surface mount power unit, 108" cord, no cut out required	OPPASU3P0U0D9BB	n/a	black	330		
		OPPASU3P0U0D9SB	n/a	silver	330		

\*\*\* Ariba and Asti modules have many different configurations available within the family offering, including hardwired solutions, email [service@symphonytables.com](mailto:service@symphonytables.com) for assistance if you are looking for additional power/data/USB features for your project.

\*\* You can daisy chain up to (4) Asti units with a 20 amp single circuit outlet

# power/data modules

Aya  
in surface

module	description	# of ports	model no.	cord length	finish code	list
Aya in surface	2 power, 1 USB A+C 2"D x 5.25"W table top cut out, specify location	3	OPPAYA2PAC0D06MS	6 ft.	MS	490
			OPPAYA2PAC0D06MW	6 ft.	MW	490
			OPPAYA2PAC0D06MB	6 ft.	MB	490
		4	OPPAYA2PAC0D10MS	10 ft.	MS	510
			OPPAYA2PAC0D10MW	10 ft.	MW	510
	2 power, 1 USB-A+C, 1 open data 2"D x 6.75"W table top cut out, specify location	4	OPPAYA2PAC1D06MS	6 ft.	MS	510
			OPPAYA2PAC1D06MW	6 ft.	MW	510
			OPPAYA2PAC1D06MB	6 ft.	MB	510
	4	OPPAYA2PAC1D10MS	10 ft.	MS	530	
		OPPAYA2PAC1D10MW	10 ft.	MW	530	
		OPPAYA2PAC1D10MB	10 ft.	MB	530	
	2 power, 1 USB-A+C, 1 HDMI 2"D x 6.75"W table top cut out, specify location	4	OPPAYA2PAC1H06MS	6 ft.	MS	570
			OPPAYA2PAC1H06MW	6 ft.	MW	570
			OPPAYA2PAC1H06MB	6 ft.	MB	570
			OPPAYA2PAC1H10MS	10 ft.	MS	590
OPPAYA2PAC1H10MW			10 ft.	MW	590	
2 power, 1 USB-A+C, 1 dual USB-C 45w 2"D x 6.75"W table top cut out, specify location	4	OPPAYA2PAC1C06MS	6 ft.	MS	730	
		OPPAYA2PAC1C06MW	6 ft.	MW	730	
		OPPAYA2PAC1C06MB	6 ft.	MB	730	
4	OPPAYA2PAC1C10MS	10 ft.	MS	750		
	OPPAYA2PAC1C10MW	10 ft.	MW	750		
	OPPAYA2PAC1C10MB	10 ft.	MB	750		
3 power, 1 open data 2"D x 6.75"W table top cut out, specify location	4	OPPAYA3P0A1D06MS	6 ft.	MS	380	
		OPPAYA3P0A1D06MW	6 ft.	MW	380	
		OPPAYA3P0A1D06MB	6 ft.	MB	380	
		OPPAYA3P0A1D10MS	10 ft.	MS	400	
		OPPAYA3P0A1D10MW	10 ft.	MW	400	
3 power, 1 USB-A+C, 2 open data 2"D x 9.75"W table top cut out, specify location	6	OPPAYA3PAC2D06MS	6 ft.	MS	590	
		OPPAYA3PAC2D06MW	6 ft.	MW	590	
		OPPAYA3PAC2D06MB	6 ft.	MB	590	
6	OPPAYA3PAC2D10MS	10 ft.	MS	610		
	OPPAYA3PAC2D10MW	10 ft.	MW	610		
	OPPAYA3PAC2D10MB	10 ft.	MB	610		

Aya in surface cut out information:

# of ports	"X" Dim.
4	6.75"W
6	9.75"W

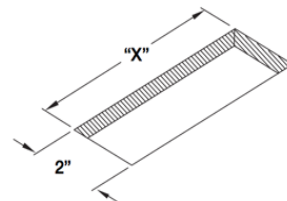

AYA SERIES FINISH CODE LEGEND:

	MS - Matte storm plastic faceplate, clear anodized aluminum housing, black cord
	MW - Matte white plastic faceplate, clear anodized aluminum housing, white cord
	MB - Matte black plastic faceplate, clear anodized aluminum housing, black cord

\*\* Aya modules have many different configurations available within the family offering, including hardwired solutions, email [service@symphonytables.com](mailto:service@symphonytables.com) for assistance if you are looking for additional power/data/USB features for your project.

# power/data modules

Aya  
freestanding and clamp mount

module	description	# of ports	model no.	cord length	finish code	list
Aya F (freestanding)	1 power, 1 USB-A+C, 1 dual USB-C 45w	3	OPPAYF1PAC1C06MS	6 ft.	MS	700
			OPPAYF1PAC1C06MW	6 ft.	MW	700
			OPPAYF1PAC1C06MB	6 ft.	MB	700
		4	OPPAYF1PAC1C10MS	10 ft.	MS	720
			OPPAYF1PAC1C10MW	10 ft.	MW	720
4	OPPAYF1PAC1C10MB	10 ft.	MB	720		
	Aya H (horizontal clamp mount)	1 power, 1 USB-A+C, 1 dual USB-C 45w	3	OPPAYH1PAC1C06MS	6 ft.	MS
OPPAYH1PAC1C06MW				6 ft.	MW	700
OPPAYH1PAC1C06MB				6 ft.	MB	700
4			OPPAYH1PAC1C10MS	10 ft.	MS	720
			OPPAYH1PAC1C10MW	10 ft.	MW	720
3		OPPAYH1PAC1C10MB	10 ft.	MB	720	
		2 power, 1 USB-A+C	3	OPPAYH2PAC0D06MS	6 ft.	MS
OPPAYH2PAC0D06MW				6 ft.	MW	510
OPPAYH2PAC0D06MB				6 ft.	MB	510
4			OPPAYH2PAC0D10MS	10 ft.	MS	530
	OPPAYH2PAC0D10MW		10 ft.	MW	530	
4	OPPAYH2PAC0D10MB	10 ft.	MB	530		

AYA SERIES FINISH CODE LEGEND:

	MS - Matte storm plastic faceplate, clear anodized aluminum housing, black cord
	MW - Matte white plastic faceplate, clear anodized aluminum housing, white cord
	MB - Matte black plastic faceplate, clear anodized aluminum housing, black cord

\*\* Aya modules have many different configurations available within the family offering, including hardwired solutions, email [service@symphonytables.com](mailto:service@symphonytables.com) for assistance if you are looking for additional power/data/USB features for your project.

# power/data modules

Beni in surface  
single-sided unit

module	description	# of ports	model no.	cord length	finish code	list
	2 power 4"D x 5"W table top cut out, specify location	2	OPP BEN2P0A0D06SS	6 ft.	SS	530
			OPP BEN2P0A0D06SW	6 ft.	SW	530
			OPP BEN2P0A0D06SB	6 ft.	SB	530
	2 power, 1 USB-A+C 4"D x 6.5"W table top cut out, specify location	3	OPP BEN2PAC0D06SS	6 ft.	SS	650
			OPP BEN2PAC0D06SW	6 ft.	SW	650
			OPP BEN2PAC0D06SB	6 ft.	SB	650
			OPP BEN2PAC0D10SS	10 ft.	SS	670
	2 power, 1 USB-A+C, 1 dual USB-C 45w 4"D x 8"W table top cut out, specify location	4	OPP BEN2P1A1C06SS	6 ft.	SS	900
			OPP BEN2P1A1C06SW	6 ft.	SW	900
OPP BEN2P1A1C06SB			6 ft.	SB	900	
OPP BEN2P1A1C10SS			10 ft.	SS	920	
2 power, 1 USB-A+C, 1 HDMI 4"D x 8"W table top cut out, specify location	4	OPP BEN2P1A1H06SS	6 ft.	SS	740	
		OPP BEN2P1A1H06SW	6 ft.	SW	740	
		OPP BEN2P1A1H06SB	6 ft.	SB	740	
		OPP BEN2P1A1H10SS	10 ft.	SS	760	
2 power, 1 USB-A+C, 1 open data 4"D x 8"W table top cut out, specify location	4	OPP BEN2P1A1H10SW	10 ft.	SW	760	
		OPP BEN2P1A1H10SB	10 ft.	SB	760	
		OPP BEN2PAC1D06SS	6 ft.	SS	650	
		OPP BEN2PAC1D06SW	6 ft.	SW	650	
2 power, 2 open data ports 4"D x 8"W table top cut out, specify location	4	OPP BEN2PAC1D06SB	6 ft.	SB	650	
		OPP BEN2PAC1D10SS	10 ft.	SS	670	
		OPP BEN2PAC1D10SW	10 ft.	SW	670	
		OPP BEN2PAC1D10SB	10 ft.	SB	670	
2 power, 2 open data ports 4"D x 8"W table top cut out, specify location	4	OPP BEN2P0A2D06SS	6 ft.	SS	540	
		OPP BEN2P0A2D06SW	6 ft.	SW	540	
		OPP BEN2P0A2D06SB	6 ft.	SB	540	
		OPP BEN2P0A2D10SS	10 ft.	SS	560	
2 power, 1 USB-A+C, 3 open data 4"D x 11"W table top cut out, specify location	6	OPP BEN2P0A2D10SW	10 ft.	SW	560	
		OPP BEN2P0A2D10SB	10 ft.	SB	560	
		OPP BEN2P1A3D06SS	6 ft.	SS	720	
		OPP BEN2P1A3D06SW	6 ft.	SW	720	
3 power, 3 open data ports 4"D x 11"W table top cut out, specify location	6	OPP BEN2P1A3D06SB	6 ft.	SB	720	
		OPP BEN2P1A3D10SS	10 ft.	SS	740	
		OPP BEN2P1A3D10SW	10 ft.	SW	740	
		OPP BEN2P1A3D10SB	10 ft.	SB	740	
3 power, 3 open data ports 4"D x 11"W table top cut out, specify location	6	OPP BEN3P0A3D06SS	6 ft.	SS	580	
		OPP BEN3P0A3D06SW	6 ft.	SW	580	
		OPP BEN3P0A3D06SB	6 ft.	SB	580	
		OPP BEN3P0A3D10SS	10 ft.	SS	600	
		OPP BEN3P0A3D10SW	10 ft.	SW	600	
		OPP BEN3P0A3D10SB	10 ft.	SB	600	

# power/data modules

Beni in surface  
back-to-back and side-to-side

module	description	# of ports	model no.	cord length	finish code	list
	Each side contains: 2 power, 1 USB-A+C, 1 open data total of 4 power, 2 USB-A+C, 2 open data per unit	8 (4/side)	OPP BEB4P2AC2D06SS	6 ft.	SS	1,350
			OPP BEB4P2AC2D06SW	6 ft.	SW	1,350
			OPP BEB4P2AC2D06SB	6 ft.	SB	1,350
	7-11/16"D x 8"W table top cut out, specify location	8 (4/side)	OPP BEB4P2AC2D10SS	10 ft.	SS	1,370
			OPP BEB4P2AC2D10SW	10 ft.	SW	1,370
			OPP BEB4P2AC2D10SB	10 ft.	SB	1,370
			OPP BEB4P0A4D06SS	6 ft.	SS	1,090
	Each side contains: 2 power, 2 open data ports total of 4 power, 4 open data ports per unit	8 (4/side)	OPP BEB4P0A4D06SW	6 ft.	SW	1,090
			OPP BEB4P0A4D06SB	6 ft.	SB	1,090
OPP BEB4P0A4D10SS			10 ft.	SS	1,110	
OPP BEB4P0A4D10SW			10 ft.	SW	1,110	
7-11/16"D x 8"W table top cut out, specify location	8 (4/side)	OPP BEB4P0A4D10SB	10 ft.	SB	1,110	
		OPP BEB4P2AC2C06SS	6 ft.	SS	1,740	
		OPP BEB4P2AC2C06SW	6 ft.	SW	1,740	
		OPP BEB4P2AC2C06SB	6 ft.	SB	1,740	
Each side contains: 2 power, 1 USB-A+C, 1 dual USB-C 45w total of 4 power, 2 USB-A+C, 2 USB-C 45w per	8 (4/side)	OPP BEB4P2AC2C10SS	10 ft.	SS	1,760	
		OPP BEB4P2AC2C10SW	10 ft.	SW	1,760	
		OPP BEB4P2AC2C10SB	10 ft.	SB	1,760	
		OPP BEB4P2AC1H1D06SS	6 ft.	SS	1,430	
Side 1 contains: 2 power, 1 USB-A+C, 1 HDMI Side 2 contains: 2 power, 1 USB-A+C, 1 open data total of 4 power, 2 USB-A+C, 1 HDMI, 1 open data per unit	8 (4/side)	OPP BEB4P2AC1H1D06SW	6 ft.	SW	1,430	
		OPP BEB4P2AC1H1D06SB	6 ft.	SB	1,430	
		OPP BEB4P2AC1H1D10SS	10 ft.	SS	1,450	
		OPP BEB4P2AC1H1D10SW	10 ft.	SW	1,450	
7-11/16"D x 8"W table top cut out, specify location	8 (4/side)	OPP BEB4P2AC1H1D10SB	10 ft.	SB	1,450	

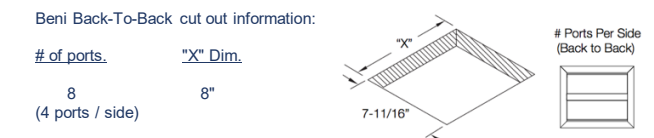

module	description	# of ports	model no.	cord length	finish code	list
	Each side contains: 2 power, 2 open data ports total of 4 power, 4 open data ports per unit	8 (4/side)	OPP BES4P0A4D06SS	6 ft.	SS	1,170
			OPP BES4P0A4D06SW	6 ft.	SW	1,170
			OPP BES4P0A4D06SB	6 ft.	SB	1,170
	4"D x 16-3/16"W table top cut out, specify location	8 (4/side)	OPP BES4P0A4D10SS	10 ft.	SS	1,190
			OPP BES4P0A4D10SW	10 ft.	SW	1,190
			OPP BES4P0A4D10SB	10 ft.	SB	1,190
			OPP BES6P0A6D06SS	6 ft.	SS	1,290
	Each side contains: 3 power, 3 open data ports total of 6 power, 6 open data ports per unit	12 (6/side)	OPP BES6P0A6D06SW	6 ft.	SW	1,290
			OPP BES6P0A6D06SB	6 ft.	SB	1,290
OPP BES6P0A6D10SS			10 ft.	SS	1,310	
OPP BES6P0A6D10SW			10 ft.	SW	1,310	
4"D x 22-3/16"W table top cut out, specify location	12 (6 ports / side)	OPP BES6P0A6D10SB	10 ft.	SB	1,310	

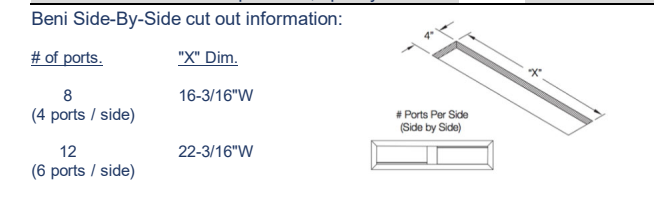

**BENI SERIES FINISH CODE LEGEND:**

- SS - Silver anodized aluminum case finish, silver trim finish, black simplex finish, black cord
- SW - Silver anodized aluminum case finish, white trim finish, white simplex finish, white cord
- SB - Silver anodized aluminum case finish, black trim finish, black simplex finish, black cord

\*Beni back-to-back and side-to-side units are also available with a single circuit breaker cord instead of 2 cords per unit, please email service@symphonytables.com for pricing.

\*\* Beni has many different configurations available within the family offering, including a hardwired solution, shared media solutions and upgraded equipment that will allow the units to daisy chain (for an upcharge), email service@symphonytables.com for assistance if you are looking for additional power/data/USB features for your project.



# power/data modules

## Circo in surface and Cova Shared Media

module	description	# of ports	model no.	cord length	finish code	list	
Circo in surface	2 power 3" diameter cut out, specify location	2	OPPCIR2P0A0D06MF	6 ft.	MF	290	
			OPPCIR2P0A0D06MS	6 ft.	MS	290	
			OPPCIR2P0A0D06MW	6 ft.	MW	290	
			OPPCIR2P0A0D06MB	6 ft.	MB	290	
			OPPCIR2P0A0D10MF	10 ft.	MF	310	
	1 power, 1 USB-A+C 3" diameter cut out, specify location	2	OPPCIR1PAC0D06MF	6 ft.	MF	380	
			OPPCIR1PAC0D06MS	6 ft.	MS	380	
			OPPCIR1PAC0D06MW	6 ft.	MW	380	
			OPPCIR1PAC0D06MB	6 ft.	MB	380	
			OPPCIR1PAC0D10MF	10 ft.	MF	400	
OPPCIR1PAC0D10MS		10 ft.	MS	400			
OPPCIR1PAC0D10MW		10 ft.	MW	400			
OPPCIR1PAC0D10MB		10 ft.	MB	400			
Circo in surface with convenience outlet		2 power, 1 convenience outlet below the worksurface 3" diameter cut out, specify location	2	OPPCIR2P0A0D106MF	6 ft.	MF	310
				OPPCIR2P0A0D106MS	6 ft.	MS	310
	OPPCIR2P0A0D106MW			6 ft.	MW	310	
	OPPCIR2P0A0D106MB			6 ft.	MB	310	
	OPPCIR2P0A0D110MF			10 ft.	MF	330	
	1 power, 1 USB-A+C, 1 convenience outlet below the worksurface 3" diameter cut out, specify location	2	OPPCIR1PAC0D106MF	6 ft.	MF	400	
			OPPCIR1PAC0D106MS	6 ft.	MS	400	
			OPPCIR1PAC0D106MW	6 ft.	MW	400	
			OPPCIR1PAC0D106MB	6 ft.	MB	400	
			OPPCIR1PAC0D110MF	10 ft.	MF	420	
OPPCIR1PAC0D110MS	10 ft.	MS	420				
OPPCIR1PAC0D110MW	10 ft.	MW	420				
OPPCIR1PAC0D110MB	10 ft.	MB	420				

Circo in surface cut out information:

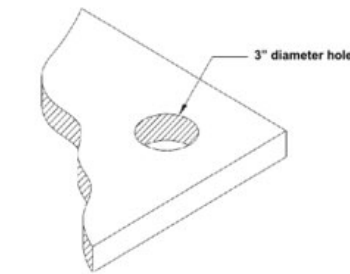

CIRCO SERIES FINISH CODE LEGEND:

- ME** - Matte Fog powdercoat finish, fog simplex finish, black cord
- MS** - Matte Storm powdercoat finish, storm simplex finish, black cord
- MW** - Matte White powdercoat finish, white simplex finish, white cord (black portion shown in image will screw in under the table top)
- MB** - Matte Black powdercoat finish, black simplex finish, black cord

### Cova Shared Media

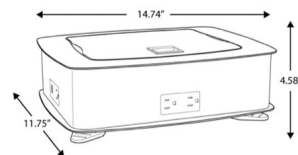

4 power, 2 dual charging USB-A, 4 HDMI Show Me cables, HDMI 4 position switch box, 15' HDMI monitor cable Carry case included.	N/A	OPPCOV4P4H2U9BB	9 ft.	BB	11,650
		OPPCOV4P4H2U9SS	9 ft.	SS	11,650
		OPPCOV4P4H2U9WW	9 ft.	WW	11,650

COVA SERIES FINISH CODE LEGEND:

- BB** - black
- SS** - silver
- WW** - white

Ideal for a portable shared media solution with easy set up additional adapter accessories available email [service@symphonytables.com](mailto:service@symphonytables.com) for assistance.

# power/data modules

## Doca freestanding and in surface and Felino in surface

module	description	# of ports	model no.	cord length	finish code	list
Doca freestanding	2 power, 1 USB-A+C, one blank no cut out required	4	OPPDO2PAC1B06GB	6 ft.	GB	460
			OPPDO2PAC1B06GW	6 ft.	GW	460
			OPPDO2PAC1B10GB	10 ft.	GB	480
			OPPDO2PAC1B10GW	10 ft.	GW	480
Doca in surface	3 power, 1 USB-A+C 3" diameter cut out, specify location	4	OPPDO3PAC0D06GB	6 ft.	GB	470
			OPPDO3PAC0D06GW	6 ft.	GW	470
			OPPDO3PAC0D10GB	10 ft.	GB	490
			OPPDO3PAC0D10GW	10 ft.	GW	490
Doca in surface cut out information:	2 power, 2 USB-A+C 3" diameter cut out, specify location	4	OPPDO2P2AC06GB	6 ft.	GB	580
			OPPDO2P2AC06GW	6 ft.	GW	580
			OPPDO2P2AC10GB	10 ft.	GB	600
			OPPDO2P2AC10GW	10 ft.	GW	600
Felino in Surface	3 power 4.5" diameter cut out required, specify location	3	OPPFEL3P0A0D06FF	6 ft.	FF	390
			OPPFEL3P0A0D06SS	6 ft.	SS	390
			OPPFEL3P0A0D06WW	6 ft.	WW	390
			OPPFEL3P0A0D06BB	6 ft.	BB	390
			OPPFEL3P0A0D10FF	10 ft.	FF	410
			OPPFEL3P0A0D10SS	10 ft.	SS	410
	2 power, 1 USB-A+C, one blank 4.5" diameter cut out required, specify location	3	OPPFEL2PAC0D06FF	6 ft.	FF	480
			OPPFEL2PAC0D06SS	6 ft.	SS	480
			OPPFEL2PAC0D06WW	6 ft.	WW	480
			OPPFEL2PAC0D06BB	6 ft.	BB	480
			OPPFEL2PAC0D10FF	10 ft.	FF	500
			OPPFEL2PAC0D10SS	10 ft.	SS	500
OPPFEL2PAC0D10WW	10 ft.	WW	500			
OPPFEL2PAC0D10BB	10 ft.	BB	500			

DOCA SERIES FINISH CODE LEGEND:

- GW** - Gloss white case finish, white trim finish, white simplex finish, molded white custom insert, white cord
- GB** - Gloss black case finish, black trim finish, black simplex finish, molded black custom insert, black cord

\*\* Doca modules have many different configurations available within the family offering, including hardwired solutions, email [service@symphonytables.com](mailto:service@symphonytables.com) for assistance if you are looking for additional power/data/USB features for your project.

Felino in surface cut out information:

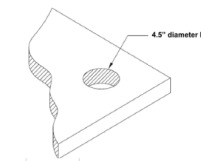

FELINO SERIES FINISH CODE LEGEND:

- FE** - Soft touch fog plastic finish
- SS** - Soft touch storm plastic finish
- WW** - Soft touch white plastic finish
- BB** - Soft touch black plastic finish

# power/data modules

Fola edge mount, Fyx and Gazzo freestanding

module	description	# of ports	model no.	cord length	finish code	list
Fola edge mount with clamp	3 power, 1 open data	4	OPPFOL3P0A1D06ST	6 ft.	ST	390
			OPPFOL3P0A1D06SW	6 ft.	SW	390
			OPPFOL3P0A1D06SB	6 ft.	SB	390
	3 power, 1 USB-A+C	4	OPPFOL3P0A1D10ST	10 ft.	ST	410
			OPPFOL3P0A1D10SW	10 ft.	SW	410
			OPPFOL3P0A1D10SB	10 ft.	SB	410
			OPPFOL3PAC0D06ST	6 ft.	ST	520
			OPPFOL3PAC0D06SW	6 ft.	SW	520
			OPPFOL3PAC0D06SB	6 ft.	SB	520
2 power, 1 USB-A+C, 1 dual USB-C 45w	4	OPPFOL3PAC0D10ST	10 ft.	ST	540	
		OPPFOL3PAC0D10SW	10 ft.	SW	540	
		OPPFOL3PAC0D10SB	10 ft.	SB	540	
		OPPFOL2PAC1C06ST	6 ft.	ST	740	
		OPPFOL2PAC1C06SW	6 ft.	SW	740	
		OPPFOL2PAC1C06SB	6 ft.	SB	740	
			OPPFOL2PAC1C10ST	10 ft.	ST	760
			OPPFOL2PAC1C10SW	10 ft.	SW	760
			OPPFOL2PAC1C10SB	10 ft.	SB	760

FOLA SERIES FINISH CODE LEGEND:



**ST** - Silver anodized aluminum case finish, storm trim and simplex finish, black cord

**SW** - Silver anodized aluminum case finish, white trim and simplex finish, white cord

**SB** - Silver anodized aluminum case finish, black trim and simplex finish, black cord

module	description	# of ports	model no.	cord length	finish code	list
Fyx Freestanding	6 power, 48" long unit clear anodized aluminum/white finish	6	OPPFYX6P0A0D06SW	6 ft.	SW	750
			OPPFYX6P0A0D10SW	10 ft.	SW	770
	6 power, 48" long unit clear anodized aluminum/black finish	6	OPPFYX6P0A0D06SB	6 ft.	SB	750
			OPPFYX6P0A0D10SB	10 ft.	SB	770

module	description	# of ports	model no.	cord length	finish code	list
Gazzo Freestanding	2 USB-A single ports, 1 USB-C	3	OPPGAZ0P2A1CSS	N/A	SS	620
	2 USB-A single ports, 1 USB-C	3	OPPGAZ0P2A1CWW	N/A	WW	620
	2 USB-A single ports, 1 USB-C	3	OPPGAZ0P2A1CBB	N/A	BB	620

GAZZO SERIES FINISH CODE LEGEND:



**SS** - Storm

**WW** - White

**BB** - Black

# power/data modules

Kita single-sided in surface

module	description	# of ports	model no.	cord length	finish code	list
Kita in surface single-sided unit	2 power, 1 USB-A+C, 1 open data port 5"D x 8"W table top cut out, specify location	4	OPPKIT2PAC1D06ST	6 ft.	ST	740
			OPPKIT2PAC1D06SW	6 ft.	SW	740
			OPPKIT2PAC1D06SB	6 ft.	SB	740
	2 power, 1 USB-A+C, 1 HDMI 5"D x 8"W table top cut out, specify location	4	OPPKIT2PAC1H06ST	6 ft.	ST	830
			OPPKIT2PAC1H06SW	6 ft.	SW	830
			OPPKIT2PAC1H06SB	6 ft.	SB	830
			OPPKIT2PAC1H10ST	10 ft.	ST	850
			OPPKIT2PAC1H10SW	10 ft.	SW	850
			OPPKIT2PAC1H10SB	10 ft.	SB	850
	3 power, 1 open data port 5"D x 8"W table top cut out, specify location	4	OPPKIT3P0A1D06ST	6 ft.	ST	600
			OPPKIT3P0A1D06SW	6 ft.	SW	600
			OPPKIT3P0A1D06SB	6 ft.	SB	600
OPPKIT3P0A1D10ST			10 ft.	ST	620	
OPPKIT3P0A1D10SW			10 ft.	SW	620	
OPPKIT3P0A1D10SB			10 ft.	SB	620	
2 power, 2 open data ports 5"D x 8"W table top cut out, specify location	4	OPPKIT2P0A2D06ST	6 ft.	ST	620	
		OPPKIT2P0A2D06SW	6 ft.	SW	620	
		OPPKIT2P0A2D06SB	6 ft.	SB	620	
		OPPKIT2P0A2D10ST	10 ft.	ST	640	
		OPPKIT2P0A2D10SW	10 ft.	SW	640	
		OPPKIT2P0A2D10SB	10 ft.	SB	640	
3 power, 3 open data ports 5"D x 11"W table top cut out, specify location	6	OPPKIT3P0A3D06ST	6 ft.	ST	650	
		OPPKIT3P0A3D06SW	6 ft.	SW	650	
		OPPKIT3P0A3D06SB	6 ft.	SB	650	
		OPPKIT3P0A3D10ST	10 ft.	ST	670	
		OPPKIT3P0A3D10SW	10 ft.	SW	670	
		OPPKIT3P0A3D10SB	10 ft.	SB	670	
2 power, 1 USB-A+C, 1 dual USB-C 45w, 2 open data ports 5"D x 11"W table top cut out, specify location	6	OPPKIT2PAC1C2D06ST	6 ft.	ST	980	
		OPPKIT2PAC1C2D06SW	6 ft.	SW	980	
		OPPKIT2PAC1C2D06SB	6 ft.	SB	980	
		OPPKIT2PAC1C2D10ST	10 ft.	ST	1,000	
		OPPKIT2PAC1C2D10SW	10 ft.	SW	1,000	
		OPPKIT2PAC1C2D10SB	10 ft.	SB	1,000	

Kita SINGLE SIDED cut out information:

# of ports	"X" Dim.
4	8"W
6	11"W

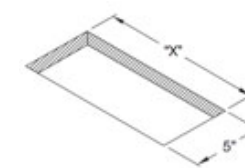

KITA SERIES FINISH CODE LEGEND:



**ST** - Silver anodized aluminum case finish, storm trim and simplex finish, black cord

**SW** - Silver anodized aluminum case finish, white trim and simplex finish, black cord

**SB** - Silver anodized aluminum case finish, black trim and simplex finish, black cord

\*\* Kita has many different configurations available within the family offering, including a hardwired solution, shared media solutions and upgraded equipment that will allow the units to daisy chain (for an upcharge), email [service@symphonytables.com](mailto:service@symphonytables.com) for assistance if you are looking for additional power/data/USB features for your project.

# power/data modules

Kita in surface back-to-back

module	description	# of ports	model no.	cord length	finish code	list
<b>Kita back-to-back unit (there are 2 cords standard per unit)</b>						
	Each side contains: 3 power, 1 open data port	8 (4/side)	OPPKIB6P0A2D06ST OPPKIB6P0A2D06SW OPPKIB6P0A2D06SB	6 ft. 6 ft. 6 ft.	ST SW SB	1,060 1,060 1,060
	Total of 6 power, 2 open data ports per unit		OPPKIB6P0A2D10ST OPPKIB6P0A2D10SW OPPKIB6P0A2D10SB	10 ft. 10 ft. 10 ft.	ST SW SB	1,080 1,080 1,080
	9-13/16"D x 8"W table top cut out					
	Each side contains: 2 power, 1 USB-A+C, 1 open data port	8 (4/side)	OPPKIB4P2AC2D06ST OPPKIB4P2AC2D06SW OPPKIB4P2AC2D06SB	6 ft. 6 ft. 6 ft.	ST SW SB	1,300 1,300 1,300
	Total of 4 power, 2 USB-A+C, 2 open data ports per unit		OPPKIB4P2AC2D10ST OPPKIB4P2AC2D10SW OPPKIB4P2AC2D10SB	10 ft. 10 ft. 10 ft.	ST SW SB	1,320 1,320 1,320
	9-13/16"D x 8"W table top cut out					
	Each side contains: 2 power, 2 open data ports	8 (4/side)	OPPKIB4P0A4D06ST OPPKIB4P0A4D06SW OPPKIB4P0A4D06SB	6 ft. 6 ft. 6 ft.	ST SW SB	1,060 1,060 1,060
	Total of 4 power, 4 open data ports per unit		OPPKIB4P0A4D10ST OPPKIB4P0A4D10SW OPPKIB4P0A4D10SB	10 ft. 10 ft. 10 ft.	ST SW SB	1,080 1,080 1,080
	9-13/16"D x 8"W table top cut out					
	Side 1 contains: 2 power, 1 USB-A+C, 1 open data Side 2 contains: 2 power 1 USB-A+C, 1 HDMI	8 (4/side)	OPPKIB4P2AC1D1H06ST OPPKIB4P2AC1D1H06SW OPPKIB4P2AC1D1H06SB	6 ft. 6 ft. 6 ft.	ST SW SB	1,490 1,490 1,490
	Total of 4 power 2 USB-A+C, 1 open data, 1 HDMI per unit		OPPKIB4P2AC1D1H10ST OPPKIB4P2AC1D1H10SW OPPKIB4P2AC1D1H10SB	10 ft. 10 ft. 10 ft.	ST SW SB	1,510 1,510 1,510
	9-13/16"D x 8"W table top cut out					
	Each side contains: 3 power, 3 open data ports	12 (6/side)	OPPKIB6P0A6D06ST OPPKIB6P0A6D06SW OPPKIB6P0A6D06SB	6 ft. 6 ft. 6 ft.	ST SW SB	1,180 1,180 1,180
	Total of 6 power, 6 open data ports per unit		OPPKIB6P0A6D10ST OPPKIB6P0A6D10SW OPPKIB6P0A6D10SB	10 ft. 10 ft. 10 ft.	ST SW SB	1,200 1,200 1,200
	9-13/16"D x 11"W table top cut out					
	Each side contains: 3 power, 1 USB-A+C, 2 open data ports	12 (6/side)	OPPKIB6P2AC4D06ST OPPKIB6P2AC4D06SW OPPKIB6P2AC4D06SB	6 ft. 6 ft. 6 ft.	ST SW SB	1,470 1,470 1,470
	Total of 6 power, 2 USB-A+C, 4 open data ports per unit		OPPKIB6P2AC4D10ST OPPKIB6P2AC4D10SW OPPKIB6P2AC4D10SB	10 ft. 10 ft. 10 ft.	ST SW SB	1,490 1,490 1,490
	9-13/16"D x 11"W table top cut out					
	Each side contains: 2 power, 1 USB-A+C, 1 dual USB-C 45W, 2 open data ports	12 (6/side)	OPPKIB4P2AC2C4D06ST OPPKIB4P2AC2C4D06SW OPPKIB4P2AC2C4D06SB	6 ft. 6 ft. 6 ft.	ST SW SB	1,850 1,850 1,850
	Total of 4 power, 2 USB-A+C, 2 dual USB-C 45w, 4 open per unit		OPPKIB4P2AC2C4D10ST OPPKIB4P2AC2C4D10SW OPPKIB4P2AC2C4D10SB	10 ft. 10 ft. 10 ft.	ST SW SB	1,870 1,870 1,870
	9-13/16"D x 11"W table top cut out					
	Side 1 contains: 3 power, 1 USB-A+C, 2 open data ports Side 2 contains: 3 power, 1 USB-A+C, 1 open data, 1 HDMI	12 (6/side)	OPPKIB6P2AC3D1H06ST OPPKIB6P2AC3D1H06SW OPPKIB6P2AC3D1H06SB	6 ft. 6 ft. 6 ft.	ST SW SB	1,550 1,550 1,550
	Total of 6 power, 2 USB-A+C, 3 open data ports, 1 HDMI per unit		OPPKIB6P2AC3D1H10ST OPPKIB6P2AC3D1H10SW OPPKIB6P2AC3D1H10SB	10 ft. 10 ft. 10 ft.	ST SW SB	1,570 1,570 1,570
	9-13/16"D x 11"W table top cut out					

**Kita Back-To-Back cut out information:**

# of ports	"X" Dim.
8 (4 ports / side)	8"W
12 (6 ports / side)	11"W

**KITA SERIES FINISH CODE LEGEND:**

- ST** - Silver anodized aluminum case finish, storm trim and simplex finish, black cord
- SW** - Silver anodized aluminum case finish, white trim and simplex finish, black cord
- SB** - Silver anodized aluminum case finish, black trim and simplex finish, black cord

\*Kita back-to-back units are also available with a single circuit breaker cord instead of 2 cords per unit, please email [service@symphonytables.com](mailto:service@symphonytables.com) for pricing.  
 \*\* Kita has many different configurations available within the family offering, including a hardwired solution, shared media solutions and upgraded equipment that will allow the units to daisy chain (for an upcharge), email [service@symphonytables.com](mailto:service@symphonytables.com) for assistance if you are looking for additional power/data/USB features for your project.

# power/data modules

Kita II single-sided in surface

module	description	# of ports	model no.	cord length	finish code	list
<b>Kita II in surface single-sided unit</b>						
	2 power, 1 USB-A+C, 1 open data port 4-7/8"D x 7-7/8"W table top cut out, specify	4	OPPKI22PAC1D06MS OPPKI22PAC1D06MW OPPKI22PAC1D06MB	6 ft. 6 ft. 6 ft.	MS MW MB	610 610 610
			OPPKI22PAC1D10MS OPPKI22PAC1D10MW OPPKI22PAC1D10MB	10 ft. 10 ft. 10 ft.	MS MW MB	630 630 630
	2 power, 1 USB-A+C, 1 HDMI 4-7/8"D x 7-7/8"W table top cut out, specify	4	OPPKI22PAC1H06MS OPPKI22PAC1H06MW OPPKI22PAC1H06MB	6 ft. 6 ft. 6 ft.	MS MW MB	700 700 700
			OPPKI22PAC1H10MS OPPKI22PAC1H10MW OPPKI22PAC1H10MB	10 ft. 10 ft. 10 ft.	MS MW MB	720 720 720
	2 power, 1 USB-A+C, 1 dual USB-C 45w 4-7/8"D x 7-7/8"W table top cut out, specify	4	OPPKI22PAC1C06MS OPPKI22PAC1C06MW OPPKI22PAC1C06MB	6 ft. 6 ft. 6 ft.	MS MW MB	830 830 830
			OPPKI22PAC1C10MS OPPKI22PAC1C10MW OPPKI22PAC1C10MB	10 ft. 10 ft. 10 ft.	MS MW MB	850 850 850
<b>Kita II + WIRELESS in surface single-sided unit</b>						
	3 power, 1 dual charging USB-A, 3 Qi coils 4-7/8" x 10-7/8" table top cut out, specify location Note that the wireless unit required a total of 6 ports	6	OPPKIW3P1A0D06MS OPPKIW3P1A0D06MW OPPKIW3P1A0D06MB	6 ft. 6 ft. 6 ft.	MS MW MB	1,120 1,120 1,120
			OPPKIW3P1A0D10MS OPPKIW3P1A0D10MW OPPKIW3P1A0D10MB	10 ft. 10 ft. 10 ft.	MS MW MB	1,140 1,140 1,140
	2 power, 1 USB-A+C, 1 open data port, 3 Qi coils 4-7/8" x 10-7/8" table top cut out, specify location Note that the wireless unit required a total of 6 ports	6	OPPKIW2PAC1D06MS OPPKIW2PAC1D06MW OPPKIW2PAC1D06MB	6 ft. 6 ft. 6 ft.	MS MW MB	1,110 1,110 1,110
			OPPKIW2PAC1D10MS OPPKIW2PAC1D10MW OPPKIW2PAC1D10MB	10 ft. 10 ft. 10 ft.	MS MW MB	1,130 1,130 1,130
<b>Kita II DEEP in surface single-sided unit</b>						
	2 power, 1 USB-A+C, 1 open data 4-7/8" x 7-7/8" table top cut out, specify location	4	OPPKID2PAC1D06MS OPPKID2PAC1D06MW OPPKID2PAC1D06MB	6 ft. 6 ft. 6 ft.	MS MW MB	740 740 740
			OPPKID2PAC1D10MS OPPKID2PAC1D10MW OPPKID2PAC1D10MB	10 ft. 10 ft. 10 ft.	MS MW MB	760 760 760

**KITA II SERIES FINISH CODE LEGEND:**

**Kita II cut out information:**

# of ports	"X" Dim.
4	7-7/8"W
6	10-7/8"W

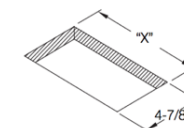

- MS** - Matte storm powder coated aluminum with matte storm powder coat simplex, window frames and end cap, white faceplate, black cord.
- MW** - Matte white powder coated aluminum with matte white powder coat simplex, window frames and end cap, white faceplate, black cord.
- MB** - Matte black powder coated aluminum with matte black powder coat simplex, window frames and end cap, black faceplate, black cord.

# power/data modules

Kita II back-to-back in surface

Macht under surface mount

module	description	# of ports	model no.	cord length	finish code	list
<b>Kita II back-to-back unit (there are 2 cords standard per unit)</b>						
	Each side contains: 3 power, 1 open data port	8	OPPK2B6P0A2D06MW	6 ft.	MW	1,030
	Total of 6 power, 2 open data ports per unit	(4/side)	OPPK2B6P0A2D06MB	6 ft.	MB	1,030
	9-3/4"D x 7-7/8"W table top cut out		OPPK2B6P0A2D10MW	10 ft.	MW	1,050
			OPPK2B6P0A2D10MB	10 ft.	MB	1,050
	Each side contains: 2 power, 1 USB-A+C, 1 open data port	8	OPPK2B4P2AC2D06MW	6 ft.	MW	1,260
	Total of 4 power, 2 USB-A+C, 2 open data ports per unit	(4/side)	OPPK2B4P2AC2D06MB	6 ft.	MB	1,260
	9-3/4"D x 7-7/8"W table top cut out		OPPK2B4P2AC2D10MW	10 ft.	MW	1,280
			OPPK2B4P2AC2D10MB	10 ft.	MB	1,280
	Each side contains: 2 power, 2 open data ports	8	OPPK2B4P0A4D06MW	6 ft.	MW	1,010
	Total of 4 power, 4 open data ports per unit	(4/side)	OPPK2B4P0A4D06MB	6 ft.	MB	1,010
	9-3/4"D x 7-7/8"W table top cut out		OPPK2B4P0A4D10MW	10 ft.	MW	1,030
			OPPK2B4P0A4D10MB	10 ft.	MB	1,030
	Side 1 contains: 2 power, 1 USB-A+C, 1 open data	8	OPPK2B4P2AC1D1H06MW	6 ft.	MW	1,340
	Side 2 contains: 2 power 1 USB-A+C, 1 HDMI	(4/side)	OPPK2B4P2AC1D1H06MB	6 ft.	MB	1,340
	Total of 4 power 2 USB-A+C, 1 open data, 1 HDMI per unit		OPPK2B4P2AC1D1H10MW	10 ft.	MW	1,360
	9-3/4"D x 7-7/8"W table top cut out		OPPK2B4P2AC1D1H10MB	10 ft.	MB	1,360
	Each side contains: 3 power, 3 open data ports	12	OPPK2B6P0A6D06MW	6 ft.	MW	1,110
	Total of 6 power, 6 open data ports per unit	(6/side)	OPPK2B6P0A6D06MB	6 ft.	MB	1,110
	9-3/4"D x 10-7/8"W table top cut out		OPPK2B6P0A6D10MW	10 ft.	MW	1,130
			OPPK2B6P0A6D10MB	10 ft.	MB	1,130
	Each side contains: 3 power, 1 USB-A+C, 2 open data ports	12	OPPK2B6P2AC4D06MW	6 ft.	MW	1,370
	Total of 6 power, 2 USB-A+C, 4 open data ports	(6/side)	OPPK2B6P2AC4D06MB	6 ft.	MB	1,370
	9-3/4"D x 10-7/8"W table top cut out		OPPK2B6P2AC4D10MW	10 ft.	MW	1,390
			OPPK2B6P2AC4D10MB	10 ft.	MB	1,390
	Each side contains: 2 power, 1 USB-A+C, 1 dual USB-C 45W, 2 open data ports	12	OPPK2B4P2AC2C4D06MW	6 ft.	MW	1,820
	Total of 4 power, 2 USB-A+C, 2 dual USB-C 45w, 4 open	(6/side)	OPPK2B4P2AC2C4D06MB	6 ft.	MB	1,820
	9-3/4"D x 10-7/8"W table top cut out		OPPK2B4P2AC2C4D10MW	10 ft.	MW	1,840
			OPPK2B4P2AC2C4D10MB	10 ft.	MB	1,840
	Side 1 contains: 3 power, 1 USB-A+C, 2 open data	12	OPPK2B6P2AC3D1H06MW	6 ft.	MW	1,450
	Side 2 contains: 3 power 1 USB-A+C, 1 open data, 1 HDMI	(6/side)	OPPK2B6P2AC3D1H06MB	6 ft.	MB	1,450
	Total of 6 power, 2 USB-A+C, 3 open data, 1 HDMI		OPPK2B6P2AC3D1H10MW	10 ft.	MW	1,470
	9-3/4"D x 10-7/8"W table top cut out		OPPK2B6P2AC3D1H10MB	10 ft.	MB	1,470

**Kita II Back-To-Back cut out information:**

# of ports.	"X" Dim.
8 (4 ports / side)	7-7/8"W
12 (6 ports / side)	10-7/8"W

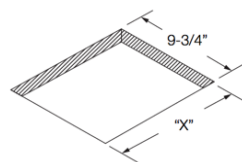

**KITA II BACK-TO-BACK SERIES FINISH CODE LEGEND:**

MW - Matte white powder coated aluminum with matte white simplexes, window frames and end cap, white faceplate, black cord.

MB - Matte black powder coated aluminum with matte black simplexes, window frames and end cap, black faceplate, black cord.

**Macht Under Surface Mount**

	6 power, black finish, 72" circuit breaker cord slide mount	6	OPPMAC6P0A0D06BK	6 ft.	BK	300
	4 power, 2 open data, black finish, 72" circuit breaker cord, slide mount	6	OPPMAC4P0A2D06BK	6 ft.	BK	280

# power/data modules

Mio single-sided in surface

module	description	# of ports	model no.	cord length	finish code	list
<b>Mio in surface single-sided unit</b>						
	3 power	3	OPPMIO3P0A0D06MS	6 ft.	MS	410
	4"D x 6.5"W table top cut out, specify location		OPPMIO3P0A0D06MW	6 ft.	MW	410
			OPPMIO3P0A0D06MB	6 ft.	MB	410
			OPPMIO3P0A0D06GS	6 ft.	GS	410
	2 power, 1 USB-A+C	3	OPPMIO2PAC0D06MS	6 ft.	MS	540
	4"D x 6.5"W table top cut out, specify location		OPPMIO2PAC0D06MW	6 ft.	MW	540
			OPPMIO2PAC0D06MB	6 ft.	MB	540
			OPPMIO2PAC0D06GS	6 ft.	GS	540
	2 power, 1 USB-A+C	3	OPPMIO2PAC0D10MS	10 ft.	MS	560
	4"D x 6.5"W table top cut out, specify location		OPPMIO2PAC0D10MW	10 ft.	MW	560
			OPPMIO2PAC0D10MB	10 ft.	MB	560
			OPPMIO2PAC0D10GS	10 ft.	GS	560
	3 power, 1 open data	4	OPPMIO3P0A1D06MS	6 ft.	MS	420
	4"D x 8"W table top cut out, specify location		OPPMIO3P0A1D06MW	6 ft.	MW	420
			OPPMIO3P0A1D06MB	6 ft.	MB	420
			OPPMIO3P0A1D06GS	6 ft.	GS	420
	3 power, 1 open data	4	OPPMIO3P0A1D10MS	10 ft.	MS	440
	4"D x 8"W table top cut out, specify location		OPPMIO3P0A1D10MW	10 ft.	MW	440
			OPPMIO3P0A1D10MB	10 ft.	MB	440
			OPPMIO3P0A1D10GS	10 ft.	GS	440
	2 power, 1 USB-A+C, 1 open data	4	OPPMIO2PAC1D06MS	6 ft.	MS	550
	4"D x 8"W table top cut out, specify location		OPPMIO2PAC1D06MW	6 ft.	MW	550
			OPPMIO2PAC1D06MB	6 ft.	MB	550
			OPPMIO2PAC1D06GS	6 ft.	GS	550
	2 power, 1 USB-A+C, 1 open data	4	OPPMIO2PAC1D10MS	10 ft.	MS	570
	4"D x 8"W table top cut out, specify location		OPPMIO2PAC1D10MW	10 ft.	MW	570
			OPPMIO2PAC1D10MB	10 ft.	MB	570
			OPPMIO2PAC1D10GS	10 ft.	GS	570
	2 power, 1 USB-A+C, 1 HDMI	4	OPPMIO2PAC1H06MS	6 ft.	MS	630
	4"D x 8"W table top cut out, specify location		OPPMIO2PAC1H06MW	6 ft.	MW	630
			OPPMIO2PAC1H06MB	6 ft.	MB	630
			OPPMIO2PAC1H06GS	6 ft.	GS	630
	2 power, 1 USB-A+C, 1 HDMI	4	OPPMIO2PAC1H10MS	10 ft.	MS	650
	4"D x 8"W table top cut out, specify location		OPPMIO2PAC1H10MW	10 ft.	MW	650
			OPPMIO2PAC1H10MB	10 ft.	MB	650
			OPPMIO2PAC1H10GS	10 ft.	GS	650

**Mio single-sided cut out information:**

# of ports.	"X" Dim.
2	5"
3	6.5"
4	8"

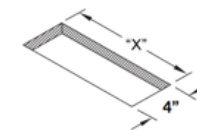

**MIO SERIES FINISH CODE LEGEND:**

MS - Matte storm powder coated aluminum with storm simplexes, window frames and end cap, black cord.

MW - Matte white powder coated aluminum with white simplexes, window frames and end cap, black cord.

MB - Matte black powder coated aluminum with black simplexes, window frames and end cap, black cord.

GS - Gloss silver powder coated aluminum with white simplexes, window frames and end cap, white cord.

# power/data modules

Mio back-to-back in surface

module	description	# of ports	model no.	cord length	finish code	list		
Mio in surface back-to-back unit	Each side contains: 3 power, 1 open data Total of 6 power, 2 open data per unit	8 (4/side)	OPPMIB6P0A2D06MS	6 ft.	MS	830		
			OPPMIB6P0A2D06MW	6 ft.	MW	830		
			OPPMIB6P0A2D06MB	6 ft.	MB	830		
			OPPMIB6P0A2D10MS	10 ft.	MS	850		
7-11/16"D x 8"L table top cut out, specify location			OPPMIB6P0A2D10MW	10 ft.	MW	850		
			OPPMIB6P0A2D10MB	10 ft.	MB	850		
			Each side contains: 2 power, 1 USB-A+C, 1 open data Total of 4 power, 2 USB-A+C, 2 open data per unit	8 (4/side)	OPPMIB4P2AC2D06MS	6 ft.	MS	1,080
					OPPMIB4P2AC2D06MW	6 ft.	MW	1,080
OPPMIB4P2AC2D06MB	6 ft.	MB			1,080			
OPPMIB4P2AC2D10MS	10 ft.	MS			1,100			
7-11/16"D x 8"L table top cut out, specify location			OPPMIB4P2AC2D10MW	10 ft.	MW	1,100		
			OPPMIB4P2AC2D10MB	10 ft.	MB	1,100		
			Each side contains: 2 power, 2 open data Total of 4 power, 2 open data per unit	8 (4/side)	OPPMIB4P0A4D06MS	6 ft.	MS	820
					OPPMIB4P0A4D06MW	6 ft.	MW	820
OPPMIB4P0A4D06MB	6 ft.	MB			820			
OPPMIB4P0A4D10MS	10 ft.	MS			840			
7-11/16"D x 8"L table top cut out, specify location			OPPMIB4P0A4D10MW	10 ft.	MW	840		
			OPPMIB4P0A4D10MB	10 ft.	MB	840		
			Each side contains: 2 power, 1 USB-A+C, 1 dual charging USB-C 45w Total of 4 power, 2 USB-A+C, 2 dual USB-C 45w per unit	8 (4/side)	OPPMIB4P2AC2C06MS	6 ft.	MS	1,690
					OPPMIB4P2AC2C06MW	6 ft.	MW	1,690
OPPMIB4P2AC2C06MB	6 ft.	MB			1,690			
OPPMIB4P2AC2C10MS	10 ft.	MS			1,710			
7-11/16"D x 8"L table top cut out, specify location			OPPMIB4P2AC2C10MW	10 ft.	MW	1,710		
			OPPMIB4P2AC2C10MB	10 ft.	MB	1,710		

Mio Back-To-Back cut out information:

# of ports. "X" Dim.  
8 8"  
(4 ports / side)

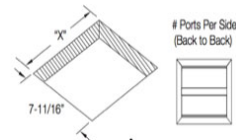

MIO SERIES FINISH CODE LEGEND:

- MS** - Matte storm powder coated aluminum with storm simplexes, window frames and end cap, black cord.
- MW** - Matte white powder coated aluminum with white simplexes, window frames and end cap, black cord
- MB** - Matte black powder coated aluminum with black simplexes, window frames and end cap, black cord.

# power/data modules

Neto clamp, in surface and under mount

module	description	# of ports	model no.	cord length	finish code	list
Neto edge mount with clamp	3 power	3	OPPNEE3P0A0D06ST	6 ft.	ST	340
			OPPNEE3P0A0D06SW	6 ft.	SW	340
			OPPNEE3P0A0D06SB	6 ft.	SB	340
			OPPNEE3P0A0D10ST	10 ft.	ST	360
			OPPNEE3P0A0D10SW	10 ft.	SW	360
			OPPNEE3P0A0D10SB	10 ft.	SB	360
	2 power, 1 USB-A+C	3	OPPNEE2PAC0D06ST	6 ft.	ST	470
			OPPNEE2PAC0D06SW	6 ft.	SW	470
			OPPNEE2PAC0D06SB	6 ft.	SB	470
			OPPNEE2PAC0D10ST	10 ft.	ST	490
			OPPNEE2PAC0D10SW	10 ft.	SW	490
			OPPNEE2PAC0D10SB	10 ft.	SB	490
2 power, 1 dual USB-C 45w	3	OPPNEE2P0A1C06ST	6 ft.	ST	570	
		OPPNEE2P0A1C06SW	6 ft.	SW	570	
		OPPNEE2P0A1C06SB	6 ft.	SB	570	
		OPPNEE2P0A1C10ST	10 ft.	ST	590	
		OPPNEE2P0A1C10SW	10 ft.	SW	590	
		OPPNEE2P0A1C10SB	10 ft.	SB	590	

Neto under mount

Neto under mount	3 power	3	OPPNEU2P0A1C06ST	6 ft.	ST	570
			OPPNEU2P0A1C06SW	6 ft.	SW	570
			OPPNEU2P0A1C06SB	6 ft.	SB	570
			OPPNEU2P0A1C10ST	10 ft.	ST	590
			OPPNEU2P0A1C10SW	10 ft.	SW	590
			OPPNEU2P0A1C10SB	10 ft.	SB	590
	2 power, 1 USB-A+C	3	OPPNEU2PAC0D06ST	6 ft.	ST	470
			OPPNEU2PAC0D06SW	6 ft.	SW	470
			OPPNEU2PAC0D06SB	6 ft.	SB	470
			OPPNEU2PAC0D10ST	10 ft.	ST	490
			OPPNEU2PAC0D10SW	10 ft.	SW	490
			OPPNEU2PAC0D10SB	10 ft.	SB	490
2 power, 1 dual USB-C 45w	3	OPPNEU2P0A1C06ST	6 ft.	ST	570	
		OPPNEU2P0A1C06SW	6 ft.	SW	570	
		OPPNEU2P0A1C06SB	6 ft.	SB	570	
		OPPNEU2P0A1C10ST	10 ft.	ST	590	
		OPPNEU2P0A1C10SW	10 ft.	SW	590	
		OPPNEU2P0A1C10SB	10 ft.	SB	590	

Neto in surface

Neto in surface	3 power 1-15/16" x 6-5/16" table top cut out, specify	3	OPPNET3P0A0D06ST	6 ft.	ST	340
			OPPNET3P0A0D06SW	6 ft.	SW	340
			OPPNET3P0A0D06SB	6 ft.	SB	340
			OPPNET3P0A0D10ST	10 ft.	ST	360
			OPPNET3P0A0D10SW	10 ft.	SW	360
			OPPNET3P0A0D10SB	10 ft.	SB	360
	2 power, 1 USB-A+C 1-15/16" x 6-5/16" table top cut out, specify	3	OPPNET2PAC0D06ST	6 ft.	ST	470
			OPPNET2PAC0D06SW	6 ft.	SW	470
			OPPNET2PAC0D06SB	6 ft.	SB	470
			OPPNET2PAC0D10ST	10 ft.	ST	490
			OPPNET2PAC0D10SW	10 ft.	SW	490
			OPPNET2PAC0D10SB	10 ft.	SB	490
2 power, 1 dual USB-C 45w 1-15/16" x 6-5/16" table top cut out, specify	3	OPPNET2P0A1C06ST	6 ft.	ST	570	
		OPPNET2P0A1C06SW	6 ft.	SW	570	
		OPPNET2P0A1C06SB	6 ft.	SB	570	
		OPPNET2P0A1C10ST	10 ft.	ST	590	
		OPPNET2P0A1C10SW	10 ft.	SW	590	
		OPPNET2P0A1C10SB	10 ft.	SB	590	
1 power, 1 USB-A+C, 1 dual USB-C 45w 1-15/16" x 6-5/16" table top cut out, specify	3	OPPNET1PAC1C06ST	6 ft.	ST	700	
		OPPNET1PAC1C06SW	6 ft.	SW	700	
		OPPNET1PAC1C06SB	6 ft.	SB	700	
		OPPNET1PAC1C10ST	10 ft.	ST	720	
		OPPNET1PAC1C10SW	10 ft.	SW	720	
		OPPNET1PAC1C10SB	10 ft.	SB	720	

Neto in surface cut out information:

# of ports. "X" Dim.  
2 4-7/8"  
3 6-5/16"

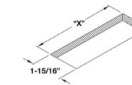

NETO EDGE MOUNT FINISH CODE LEGEND:

- ST** - Storm molded plastic faceplate and endcaps, Silver anodized aluminum housing and mount, black cord
- SW** - White molded plastic faceplate and endcaps, Silver anodized aluminum housing and mount, white cord
- SB** - Black molded plastic faceplate and endcaps, Silver anodized aluminum housing and mount, black cord





# power/data modules

Ocho

above surface clamp mount, in surface flush, in surface pop up , under surface

module	description	# of ports	model no.	cord length	finish code	list		
Ocho above surface clamp mount	1 power, 1 USB-A 2.4 amp, 1 USB-C 60w	2	OPPOCA1PAC06B	6 ft.	B	450		
			OPPOCA1PAC06G	6 ft.	G	450		
			OPPOCA1PAC06S	6 ft.	S	450		
			OPPOCA1PAC06W	6 ft.	W	450		
			OPPOCA1PAC10B	10 ft.	B	470		
			OPPOCA1PAC10G	10 ft.	G	470		
			OPPOCA1PAC10S	10 ft.	S	470		
			OPPOCA1PAC10W	10 ft.	W	470		
			2 power, 1 USB-A 2.4 amp, 1 USB-C 60w	3	OPPOCA2PAC06B	6 ft.	B	480
					OPPOCA2PAC06G	6 ft.	G	480
					OPPOCA2PAC06S	6 ft.	S	480
					OPPOCA2PAC06W	6 ft.	W	480
					OPPOCA2PAC10B	10 ft.	B	500
					OPPOCA2PAC10G	10 ft.	G	500
			3 power, 1 USB-A 2.4 amp, 1 USB-C 60w, 1 HDMI	5	OPPOCA3PAC06B	6 ft.	B	550
OPPOCA3PAC06G	6 ft.	G			550			
OPPOCA3PAC06S	6 ft.	S			550			
OPPOCA3PAC06W	6 ft.	W			550			
OPPOCA3PAC10B	10 ft.	B			570			
OPPOCA3PAC10G	10 ft.	G			570			
OPPOCA3PAC10S	10 ft.	S			570			
OPPOCA3PAC10W	10 ft.	W			570			
Ocho flush in surface	2 power, 1 USB-A 2.4 amp, 1 USB-C 60w 2.19" x 6" table top cut out, specify location	3			OPPOCF2PAC06B	6 ft.	B	460
			OPPOCF2PAC06G	6 ft.	G	460		
			OPPOCF2PAC06S	6 ft.	S	460		
			OPPOCF2PAC06W	6 ft.	W	460		
			OPPOCF2PAC10B	10 ft.	B	480		
			OPPOCF2PAC10G	10 ft.	G	480		
			OPPOCF2PAC10S	10 ft.	S	480		
			OPPOCF2PAC10W	10 ft.	W	480		
			3 power, 1 USB-A 2.4 amp, 1 USB-C 60w, 1 HDMI 2.19" x 8.5" table top cut out, specify location	5	OPPOCF3PAC06B	6 ft.	B	540
					OPPOCF3PAC06G	6 ft.	G	540
					OPPOCF3PAC06S	6 ft.	S	540
					OPPOCF3PAC06W	6 ft.	W	540
					OPPOCF3PAC10B	10 ft.	B	560
					OPPOCF3PAC10G	10 ft.	G	560
			Ocho in surface pop-up	2 power 1 dual charging USB-A 4.746"D x 6.79"W table top cut out, specify location	3	OPPOCH2P1U06B	6 ft.	B
OPPOCH2P1U06G	6 ft.	G				550		
OPPOCH2P1U06S	6 ft.	S				550		
OPPOCH2P1U06W	6 ft.	W				550		
OPPOCH2P1U10B	10 ft.	B				570		
OPPOCH2P1U10G	10 ft.	G				570		
OPPOCH2P1U10S	10 ft.	S				570		
OPPOCH2P1U10W	10 ft.	W				570		
Ocho under surface mount	2 power, 1 USB-A 2.4 amp, 1 USB-C 60w	3				OPPOCU2PAC06B	6 ft.	B
			OPPOCU2PAC06G	6 ft.	G	480		
			OPPOCU2PAC06S	6 ft.	S	480		
			OPPOCU2PAC06W	6 ft.	W	480		
			OPPOCU2PAC10B	10 ft.	B	500		
			OPPOCU2PAC10G	10 ft.	G	500		
			OPPOCU2PAC10S	10 ft.	S	500		
			OPPOCU2PAC10W	10 ft.	W	500		
			3 power, 1 USB-A 2.4 amp, 1 USB-C 60w, 1 HDMI	5	OPPOCU3PAC06B	6 ft.	B	550
					OPPOCU3PAC06G	6 ft.	G	550
					OPPOCU3PAC06S	6 ft.	S	550
					OPPOCU3PAC06W	6 ft.	W	550
					OPPOCU3PAC10B	10 ft.	B	570
					OPPOCU3PAC10G	10 ft.	G	570
			3 power, 1 USB-A 2.4 amp, 1 USB-C 60w, 1 HDMI	5	OPPOCU3PAC10S	10 ft.	S	570
OPPOCU3PAC10W	10 ft.	W			570			

**OCHO SERIES FINISH CODE LEGEND:**

-  B - Black plastic face, black metal trim, black cord
-  S - White plastic face, silver metal trim, white cord
-  G - Grey plastic face, silver metal trim, black cord
-  W - White plastic face, white metal trim, white cord



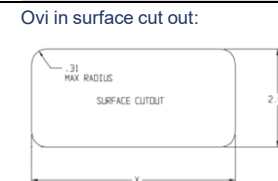

# power/data modules

Ovi in surface

module	description	model no.	cord length	finish code	list		
Ovi with convenience outlet(s)	2 power, 1 convenience outlet below the worksurface 2"D x 5.25"W table top cut out size - specify placement	OPPOVI2P0U91SB	9 ft.	SB	430		
		OPPOVI2P0U91BB	9 ft.	BB	430		
		OPPOVI2P0U91GW	9 ft.	GW	430		
		OPPOVI2P0U91AB	9 ft.	AB	530		
		** You can daisy chain up to (4) Ovi units with a 20 amp single circuit outlet					
		2 power, 1 dual charging USB-A, 2 convenience outlets below the 2"D x 7.25"W table top cut out size - specify placement	OPPOVI2P1U92SB	9 ft.	SB	750	
			OPPOVI2P1U92BB	9 ft.	BB	750	
			OPPOVI2P1U92GW	9 ft.	GW	750	
			OPPOVI2P1U92AB	9 ft.	AB	840	
		** You can daisy chain up to (4) Ovi units with a 20 amp single circuit outlet					
		3 power, 1 dual charging USB-A, 1 convenience outlet below the worksurface 2"D x 7.25"W table top cut out size - specify placement	OPPOVI3P1U91SB	9 ft.	SB	720	
			OPPOVI3P1U91BB	9 ft.	BB	720	
			OPPOVI3P1U91GW	9 ft.	GW	720	
		** You can daisy chain up to (4) Ovi units with a 20 amp single circuit outlet					
		Ovi (no convenience outlets)	2 power 2"D x 4.5"W table top cut out size - specify placement	OPPOVI2P0U9SB	9 ft.	SB	410
OPPOVI2P0U9BB	9 ft.			BB	410		
OPPOVI2P0U9GW	9 ft.			GW	410		
OPPOVI2P0U9AB	9 ft.			AB	480		
1 power, 1 dual charging USB-A 2"D x 4.5"W table top cut out size - specify placement	OPPOVI1P1U9SB		9 ft.	SB	550		
	OPPOVI1P1U9BB		9 ft.	BB	550		
	OPPOVI1P1U9GW		9 ft.	GW	550		
2 power, 1 dual charging USB-A 2"D x 5.25"W table top cut out size - specify placement	OPPOVI2P1U9SB		9 ft.	SB	570		
	OPPOVI2P1U9BB		9 ft.	BB	570		
	OPPOVI2P1U9GW		9 ft.	GW	570		
3 power 2"D x 5.75"W table top cut out size - specify placement	OPPOVI3P0U9SB		9 ft.	SB	610		
	OPPOVI3P0U9BB		9 ft.	BB	610		
	OPPOVI3P0U9GW		9 ft.	GW	610		
3 power, 1 dual charging USB-A 2"D x 7.25"W table top cut out size - specify placement	OPPOVI3P1U9SB		9 ft.	SB	720		
	OPPOVI3P1U9BB		9 ft.	BB	720		
	OPPOVI3P1U9GW	9 ft.	GW	720			
4 power 2"D x 7.25"W table top cut out size - specify placement	OPPOVI4P0U9SB	9 ft.	SB	660			
	OPPOVI4P0U9BB	9 ft.	BB	660			
	OPPOVI4P0U9GW	9 ft.	GW	660			
4 power, 1 dual charging USB-A 2"D x 8.25"W table top cut out size - specify placement	OPPOVI4P1U9SB	9 ft.	SB	750			
	OPPOVI4P1U9BB	9 ft.	BB	750			
	OPPOVI4P1U9GW	9 ft.	GW	750			
6 power 2"D x 10.25"W table top cut out size - specify placement	OPPOVI6P0U9SB	9 ft.	SB	690			
	OPPOVI6P0U9BB	9 ft.	BB	690			
	OPPOVI6P0U9GW	9 ft.	GW	690			
Ovi Round (no convenience outlets)	1 power, 1 dual charging USB-A 2"D x 4.5"W table top cut out size - specify placement	OPPOVR1P1U9SB	9 ft.	SB	550		
		OPPOVR1P1U9BB	9 ft.	BB	550		
		OPPOVR1P1U9GW	9 ft.	GW	550		
	2 power, 1 dual charging USB-A 2"D x 5.25"W table top cut out size - specify placement	OPPOVR2P1U9SB	9 ft.	SB	570		
		OPPOVR2P1U9BB	9 ft.	BB	570		
		OPPOVR2P1U9GW	9 ft.	GW	570		
	2 power 2"D x 4.5"W table top cut out size - specify placement	OPPOVR2P0U9SB	9 ft.	SB	420		
		OPPOVR2P0U9BB	9 ft.	BB	420		
		OPPOVR2P0U9GW	9 ft.	GW	420		



**OVI SERIES FINISH CODE LEGEND:**

-  SB - Silver powdercoat finish, black simplex finish
-  BB - black powdercoat finish, black simplex finish
-  GW - Gloss white powdercoat finish, white simplex finish
-  AB - brushed aluminum finish, black simplex finish (not available on Ovi Round units)

\* REFERENCE THE CUT OUT SIZE UNDER EACH OVI POWER MODULE FOR THE VALUE OF "X"



# power/data modules

Palla in surface, Pila freestanding, Power Strip

Versie under mount

module	description	model no.	cord length	finish code	list
Palla	3 power 3" diameter table top cut out size, specify location	OPPPAL3P0A0D06SS	6 ft.	SS	230
		OPPPAL3P0A0D06WW	6 ft.	WW	230
		OPPPAL3P0A0D06BB	6 ft.	BB	230
		OPPPAL3P0A0D10SS	10 ft.	SS	250
		OPPPAL3P0A0D10WW	10 ft.	WW	250
		OPPPAL3P0A0D10BB	10 ft.	BB	250
Palla	2 power, 1 USB-A+C 3" diameter table top cut out size, specify location	OPPPAL2PAC0D06SS	6 ft.	SS	350
		OPPPAL2PAC0D06WW	6 ft.	WW	350
		OPPPAL2PAC0D06BB	6 ft.	BB	350
		OPPPAL2PAC0D10SS	10 ft.	SS	370
		OPPPAL2PAC0D10WW	10 ft.	WW	370
		OPPPAL2PAC0D10BB	10 ft.	BB	370



PALLA SERIES FINISH CODE LEGEND:

-  **SS** - Storm case, trim, and simplex finish, black cord
-  **WW** - White case, trim, and simplex finish, white cord
-  **BB** - Black case, trim, and simplex finish, black cord

Pila Freestanding

	3 power, 2 USB-A, 1 USB-C 18W	OPPPIL3P2A1C10SS	10 ft.	SS	1,530
	12" diameter x 28-1/4"H	OPPPIL3P2A1C10WW	10 ft.	WW	1,530
		OPPPIL3P2A1C10BB	10 ft.	BB	1,530



PILA SERIES FINISH CODE LEGEND:

-  **SS** - Storm trim in molded plastic, Storm base and neck in powder coated aluminum, black cord
-  **WW** - White trim in molded plastic, White base and neck in powder coated aluminum, white cord
-  **BB** - Black trim in molded plastic, Black base and neck in powder coated aluminum, black cord

Power strip (under mount)

	6-outlet, UL tested/listed	OPPSTR6P0D06B	6 ft.	black	120
		OPPSTR6P0D15B	15 ft.	black	200
		OPPSTR6P0D25B	25 ft.	black	250
		OPPSTR6P0D06G	6 ft.	grey	120
		OPPSTR6P0D15G	15 ft.	grey	200
		OPPSTR6P0D25G	25 ft.	grey	250

Versie under mount

	2 power	OPPVER2P0A0D06BK	6 ft.	BK	190
		OPPVER2P0A0D10BK	10 ft.	BK	210
	1 power, 1 USB-A+C	OPPVER1PAC0D06BK	6 ft.	BK	310
		OPPVER1PAC0D10BK	10 ft.	BK	330
	1 power, 1 open data	OPPVER1P0A1D06BK	6 ft.	BK	190
		OPPVER1P0A1D10BK	10 ft.	BK	210



# power/data modules

Versie in surface, Wayne in surface

Zig freestanding

module	description	model no.	cord length	finish code	list
Versie in surface	2 power 2"D x 3.25"W table top cut out required, specify location	OPPVES2P0A0D06MS	6 ft.	MS	380
		OPPVES2P0A0D06MW	6 ft.	MW	380
		OPPVES2P0A0D06MB	6 ft.	MB	380
		OPPVES2P0A0D10MS	10 ft.	MS	400
		OPPVES2P0A0D10MW	10 ft.	MW	400
		OPPVES2P0A0D10MB	10 ft.	MB	400
Versie in surface	1 power, 1 USB-A+C 2"D x 3.25"W table top cut out required, specify location	OPPVES1PAC0D06MW	6 ft.	MW	490
		OPPVES1PAC0D06MB	6 ft.	MB	490
		OPPVES1PAC0D10MS	10 ft.	MS	510
		OPPVES1PAC0D10MW	10 ft.	MW	510
		OPPVES1PAC0D10MB	10 ft.	MB	510

VERSIE IN SURFACE SERIES FINISH CODE LEGEND:

-  **MS** - Matte Storm finish, black cord
-  **MW** - Matte White finish, black cord
-  **MB** - Matte Black finish, black cord

\*\*these finishes are not available for the Versie undermount unit

Wayne Shared Media



	4 power, 2 dual charging USB-A	OPPWAM4P4H2U9	9 ft.	BB	9,930
	4 HDMI Show Me cables	OPPWAM4P4H2U9	9 ft.	SS	9,930
	HDMI 4 position switch box	OPPWAM4P4H2U9	9 ft.	WW	9,930

15' HDMI monitor cable, 108" cord.  
Sliding door grommet included  
7.5"D x 12.125"W table top cut out, specify location

there is room for (2) telecom data plates in this unit  
plates are not included in the price but they can be purchased separately

additional adapter accessories available  
email [service@symphonytables.com](mailto:service@symphonytables.com) for assistance.



WAYNE SHARED MEDIA SERIES FINISH CODE LEGEND:

-  **BB** - Black grommet finish
-  **SS** - Silver grommet finish
-  **WW** - White grommet finish







Zig freestanding

Zig freestanding	1 power, 1 USB-A+C	OPPZIG1PAC0D09BW	9 ft.	BW	470
		OPPZIG1PAC0D09WB	9 ft.	WB	470
		OPPZIG1PAC0D09BB	9 ft.	BB	470

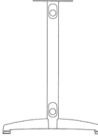
ZIG SERIES FINISH CODE LEGEND:

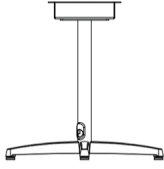
-  **BW** - Beech wood case, White trim/simplex finish, solid dusk braided cord
-  **WB** - Walnut wood case, Black trim/simplex finish, black and white pinstripe cord
-  **BB** - Black wood case, Black trim/simplex finish, black and white pinstripe cord

# wire management

	description	model no.	list
	<b>Zoey wire management hole</b> the cord will route through the mouse hole and exit at the bottom of the column (1) 1.5" hole at the top / inside of 1 column for a single T or C type base (2) 1.5" holes at the top / inside of each column for a set of (2) T or C type bases (1) 1.25" hole at the top / inside of 1 column for Zoey TT, X, 4X, Y or YY bases (not available for adj ht bases)	OBTWMH1Z 50 OBTWMH2Z 100 OBWMZCONF 50	
	<b>Ria / Keller wire management holes for one single column of a T, C, TT, or 4X base</b> wire management mouse holes (top & bottom) for one base Each hole is a 1.5" x 2.25" oval. Removeable grommets narrow the hole to 1.25" diameter Note that the wire management grommet cannot be made with the polished finish, specify black or white (not available for adj ht bases)	OBTWMH2RG 60	
	<b>Ria / Keller wire management cone shaped top plate and WM hole</b> metal cone-shaped top plate conceals and protects center mounted power module in surface Concealed wires exit down inside the base column and out at the bottom of the base column Available for single column Ria and Keller X and Y bases Note that the cone cannot be made with the polished finish black or white paint is available for the cone with a polished base Circo in surface power unit can be used with this cone wire manager (not available for adj ht bases)	OBXWMPCC 350	
	<b>Ria / Keller wire management box shaped top plate and WM hole</b> metal box-shaped top plate conceals and protects center mounted power module in surface Concealed wires exit down inside the base column and out at the bottom of the base column Available for single column Ria and Keller X and Y bases Note that the box cannot be made with the polished finish black or white paint is available for the box with a polished base Inside dimensions: 9.5" x 9.5" x 2.75"H, 1.75" access hole in top plate to column (not available for adj ht bases)	OBXWMPBB 470	
	<b>Moto Magnetic wire manager for a square or rectangular column</b> standard dimensions: 17 3/4" length, 2" width, 1.06" depth large area for wire management of multiple power and cord sizes easy installation and reposition to any metal surface ** specify metal finish - not available in a polished or wrinkle finish	OBWMMM18 120	
	<b>Moto wire management holes for T, C, X, post or Moto II frame base</b> 1.25" dia. wire management mouse holes (top & bottom) for one 2" sq base column 1.5" dia. wire management mouse holes (top & bottom) for one 3" sq base column (not available for adj ht bases or Moto Frame bases with 2.5 x 2.5 tubing)	OBWMHMOTO 60 OBWMHMOTO-1.5 60	
	<b>Novi T type bases wire management holes for one single column</b> Each hole is a 1.5" x 2.25" oval. Removeable grommets narrow the hole to 1.25" diameter Note that the wire management grommet cannot be made with the polished finish, specify black or white (not available for adj ht or polished chrome bases)	OBTWMNOVI 100	
	<b>Nantes disc / Marius disc / Moto X / Novi X</b> power box mounting plate with (1) 1.25" mouse hole in the column near the bottom for the cord to exit to a wall or floor outlet away from the base  -Power Box Dimensions 12" x 12", 3" high from top of the column to table top -Power Box Hole Dimensions: 2" dia. on a 3" column, 3 1/2" dia on a 4" column	OBWMPD1H 140	
	<b>Nantes / Marius power box mounting plate with wire management hole centered under the disc base</b> wire management hole in the center of a Nantes / Marius disc base for floor access -3" column has a 1 7/8" dia thru hole at bottom / center -4" column has a 2 1/4" dia thru hole at the bottom / center	OBDWMPDHCF 230	

\*Please note that power supply units and cords vary in size and shape. Please email [service@symphonytables.com](mailto:service@symphonytables.com) to ensure that your power supply and cord will work with the table specifications and desired wire management options.

# wire management

	description	model no.	list
	<b>metal snap on</b> (not available for adjustable ht bases) easy to attach, access, or move metal finish to match base, SPECIFY FINISH (not available in a polished or wrinkle finish) 2" round column version 3" round column version ** Can be used with any base that has a 2" or 3" round column	AWMRM2NB 90 AWMRM3NB 100	
	<b>universal wire manager</b> black (B) 26" silver (S) 26" double stick tape is used to adhere the wire manager to the base	OBTWMUPB 60 OBTWMUPS 60	
	<b>J channel black nylon wire manager with double stick tape</b> 2.5" x 1" x 71" long 2.5" x 1" x 59" long 2.5" x 1" x 47" long 2.5" x 1" x 35" long 2.5" x 1" x 23" long	AWMJCH72 210 AWMJCH60 170 AWMJCH48 150 AWMJCH36 110 AWMJCH24 90	
	<b>large J channel 72" wire manager with double stick tape</b> Black nylon 3 1/4" x 1" x 71" long additional lengths available	AWMJP72B 250	
	<b>Metal J-style wire manager</b> <b>Standard metal powder coat finishes</b> Flat Black, Furniture White, Inner Tone, Light Tone, Medium Tone, and Metallic Silver (not for use with flip nest tables)	36"W x 4.93"D x 6"H AWMJCM36 190 47"W x 4.93"D x 6"H AWMJCM47 230 59"W x 4.93"D x 6"H AWMJCM59 250 71"W x 4.93"D x 6"H AWMJCM71 280	
	<b>36" wire management basket</b> sturdy basket made of high quality powder coated steel, black finish 36" long x 5.75"D x 3.5"H exterior dimensions	AWMWB36B 230	
	<b>wire clip set</b> perfect for single power cord or small group of data cords cables easily installed or removed without removing clip .4" wide x 1.156" long with .50" cable bundle diameter natural nylon set of (10) includes (10) wood screws to attach under surface additional sizes available	AWMCL10N 40	
	<b>Spiral wire manager</b> mounted under the worksurface for wire management to the floor, easy to install for use under fixed worksurface up to 30"H	black finish AWMVSL-BK 180 silver finish AWMVSL-S 180 white finish AWMVSL-W 180	
	<b>Spine wire manager</b> mounted under the worksurface for wire management to the floor, conceals wires inside easy to install, 3 colors available, for fixed or adjustable height tables up to 51"H	black finish AWMVSP-BK 230 silver finish AWMVSP-S 230 white finish AWMVSP-W 230	



# round grommets

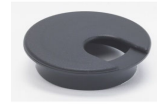

description	model no.	list
nylon 2" diameter, black	OTGRD2NB	60
nylon 2" diameter, white	OTGRD2NW	60
nylon 2" diameter, silver	OTGRD2NS	60



nylon 3" diameter, black	OTGRD3NB	60
nylon 3" diameter, white	OTGRD3NW	60
nylon 3" diameter, silver	OTGRD3NS	60

Specify the grommet location on your PO, note that the above pricing is for a single (1) grommet, if you specify a grommet location that shows (2) grommets then you will need to include 2 grommets per table on your PO. Email [service@symphonytables.com](mailto:service@symphonytables.com) for assistance.

## GROMMET LOCATIONS

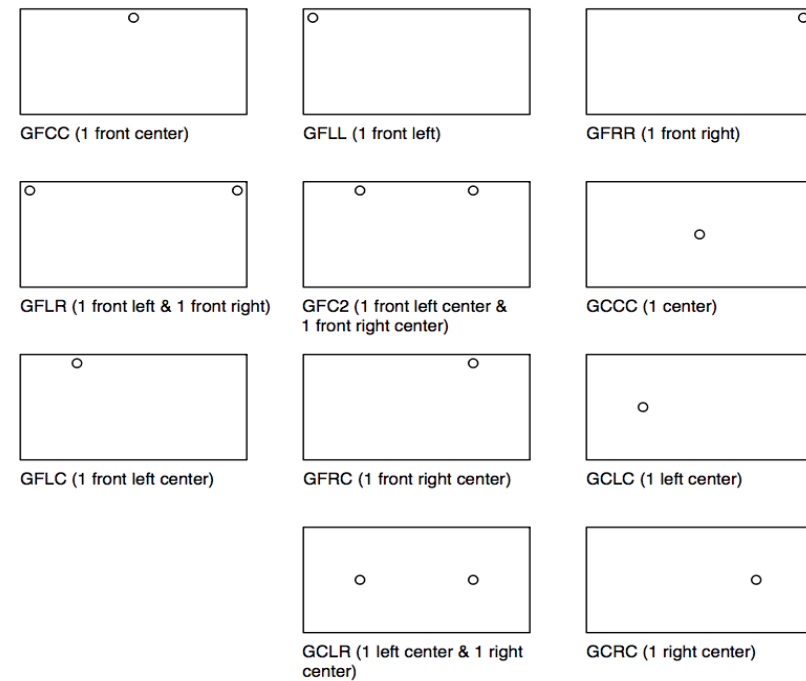

# rectangular grommets

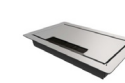

Asti metal 3.39" x 5.68" grommet with flush hinged door	list
flush hinged door, black finish	OTGRADMB 150
flush hinged door, silver finish	OTGRADMS 150
flush hinged door, white finish	OTGRADMW 150
flush hinged door, Brushed Aluminum finish	OTGRADBA 240
flushhinged door, Stainless Steel finish	OTGRADSS 240

3" x 5.25" cut out required

Specify the grommet location on your PO, note that the above pricing is for a single (1) grommet, if you specify a grommet location that shows (2) grommets then you will need to include 2 grommets per table on your PO. Email [service@symphonytables.com](mailto:service@symphonytables.com) for assistance.

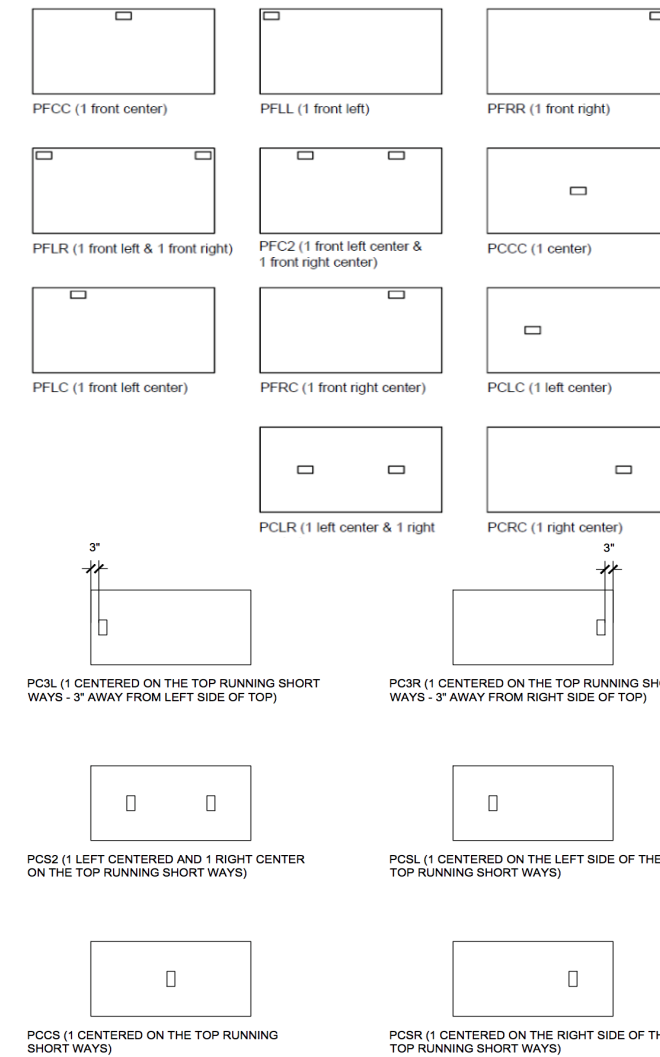

# modesty panels

## fixed

material	description	width	model no.	list
laminite fixed (LX)	<b>8" high fixed laminate modesty panel</b> Select laminate and edge color 3/8" thick particle board laminated with 0.050" thick plastic available with PVC or laminate edge Attaches with "L" bracket fixed hardware	35.5	OMLX836	210
		41.5	OMLX842	270
		47.5	OMLX848	280
		53.5	OMLX854	380
		59.5	OMLX860	390
		65.5	OMLX866	460
	* Contact customer service to ensure that any power or accessories you plan to specify will work with this modesty panel and your base selection, email <a href="mailto:service@symphonytables.com">service@symphonytables.com</a>	71.5	OMLX872	470
	<b>laminite fixed modesty wire channel</b>			list
	60" x 3" x 3" black 72" x 3" x 3" black attaches to inside of laminate modesty with factory installed double sided tape additional lengths available	59.5 71.5	AWMLXWC5 AWMLXWC6	230 250
perforated metal fixed (MP)	<b>9" high perforated metal fixed modesty panel</b> Inside metal wire raceway included 20 gauge fabricated steel	35.75	OMMP936	610
		47.75	OMMP948	650
		59.75	OMMP960	720
		71.75	OMMP972	840
	(ME) Standard metal powder coat finishes : Flat Black (FB), Furniture White (FW), Inner Tone (IT), Light Tone (LT), Medium Tone (MT), Metallic Silver (MS).			
	* Contact customer service to ensure that any power or accessories you plan to specify will work with this modesty panel and your base selection,			
solid metal fixed (MS)	<b>9" high solid metal fixed modesty panel</b> Inside metal wire raceway included 20 gauge fabricated steel	35.75	OMMS936	600
		47.75	OMMS948	640
		59.75	OMMS960	710
		71.75	OMMS972	830
	(ME) Standard metal powder coat finishes : Flat Black (FB), Furniture White (FW), Inner Tone (IT), Light Tone (LT), Medium Tone (MT), Metallic Silver (MS).			
	* Contact customer service to ensure that any power or accessories you			
acrylic fixed (AX)	<b>8" high acrylic modesty panel</b> 3/8" double sided frosted acrylic panel includes (2) brackets and covers for 48" panels includes (3) brackets and covers for 60" & 72" panels silver (S) or black (B) brackets available	47.5	OMAX948S	560
		59.5	OMAX960S	830
		71.5	OMAX972S	840
		47.5	OMAX948B	560
	* Contact customer service to ensure that any power or accessories you plan to specify will work with this modesty panel and your base selection, email <a href="mailto:service@symphonytables.com">service@symphonytables.com</a>	59.5	OMAX960B	720
		71.5	OMAX972B	840

We recommend using tops with 90 degree corners to allow the modesty to be flush with the front (PVEA for example).  
For tops with radiused corners, the modesty must be positioned back from the front edge.

# modesty panels



## for flip/nest tables

material	description	width	model no.	list
fabric hanging (FH)	<b>10" high fabric hanging modesty panel</b> Black mesh fabric with black liner Additional non-standard widths available up to 72" wide. Steel rod frame Pivot hardware allows modesty to swing & fold for easy storage Hidden wire raceway on inside is secured with multiple Velcro strips.	35.75	OMFH1036	290
		41.75	OMFH1042	300
		47.75	OMFH1048	310
		53.75	OMFH1054	320
		59.75	OMFH1060	330
		65.75	OMFH1066	340
	* Contact customer service to ensure that any power / accessories you plan to specify will work with this modesty panel, email <a href="mailto:service@symphonytables.com">service@symphonytables.com</a>	71.75	OMFH1072	350
laminite hanging (LH)	<b>8" high hanging laminate modesty panel (Do not use with C bases)</b> Select laminate and edge color 3/8" thick particle board laminated with 0.050" thick plastic laminate available with PVC or laminate edge attaches with Nester series hanging modesty panel bracket	35.5	OMLH836	420
		41.5	OMLH842	480
		47.5	OMLH848	490
		53.5	OMLH854	590
		59.5	OMLH860	600
		65.5	OMLH866	670
	**Do not use the laminate hanging modesty panel for Zoey or Keller flip nest tables over 24" deep, 24" deep tops are OK but any other size over 24" could result in the modesty panel hitting the legs when the table is in the nested position.	71.5	OMLH872	680
	* the modesty panel will flip "DOWN" (do not use with C type bases)			
	* Contact customer service to ensure that any power or accessories you plan to specify will work with this modesty panel and your base selection, email <a href="mailto:service@symphonytables.com">service@symphonytables.com</a>			
laminite reverse hinge (RH)	<b>8" high reverse hinge laminate modesty panel for Zoey / Keller over 24" deep or flip nest base table - the modesty panel shall flip "UP" when the table is in the nested position</b> Select laminate and edge color 3/8" thick particle board laminated with 0.050" thick plastic laminate available with PVC or laminate edge attaches with Reverse hinge modesty panel bracket For Zoey or Keller flip nest tables that are over 24" deep or ANY "C" type base flip / nest table so the modesty panel will flip up instead of down	35.5	OMRH836	490
		41.5	OMRH842	550
		47.5	OMRH848	560
		53.5	OMRH854	660
	59.5	OMRH860	670	
	65.5	OMRH866	740	
	71.5	OMRH872	750	
	* modesty panel will flip "UP"			
	* Contact customer service to ensure that any power or accessories you plan to specify will work with this modesty panel and your base selection, email <a href="mailto:service@symphonytables.com">service@symphonytables.com</a>			
perforated metal for flip nest (PH)	<b>9" high perforated metal modesty panel</b> .125 diameter holes on a 2 x 2 inch grid reverse hinge modesty panel bracket	47-7/8	OMPH948	730
		59-7/8	OMPH960	780
		71-7/8	OMPH972	860
	(ME) Standard metal powder coat finishes : Flat Black (FB) or Metallic Silver (MS). **Additional powder coat metal finishes are available on orders with a quantity of 10+ modesty panels in the same size and finish			
	* modesty panel will flip "UP"			
	* Contact customer service to ensure that any power or accessories you plan to specify will work with this modesty panel and your base selection, email <a href="mailto:service@symphonytables.com">service@symphonytables.com</a>			
acrylic for flip nest (AH)	<b>8" high acrylic modesty panel</b> 3/8" double sided frosted acrylic panel includes (2) brackets and covers for 48" panels includes (3) brackets and covers for 60" & 72" panels silver (S) or black (B) brackets available	47.5	OMAH948S	590
		59.5	OMAH960S	780
		71.5	OMAH972S	900
		47.5	OMAH948B	590
	* Contact customer service to ensure that any power or accessories you plan to specify will work with this modesty panel and your base selection, email <a href="mailto:service@symphonytables.com">service@symphonytables.com</a>	59.5	OMAH960B	780
		71.5	OMAH972B	900
	* modesty panel will flip "DOWN"			

We recommend using tops with 90 degree corners to allow the modesty to be flush with the front (PVEA for example).  
For tops with radiused corners, the modesty must be positioned back from the front edge.

# accessories

## locks and anti-sag bars

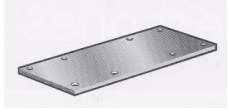
	description	model no.	list
<b>Table Locks and Plates</b>    	<b>Small Table Lock Set</b> 3" x 6" heavy-duty 11 gauge steel plate set includes 2 plates, 8 knobs (4 per plate), inserts for each seam plates retract and hide away when not in use Black finish	OTL2P8KB	160
	<b>Large Plate Lock</b> 4" x 12" heavy-duty 11 gauge steel plate includes 1 plate, 4 knobs, inserts for each seam one plate attaches tables up to 42" deep plates retract and hide away when not in use Black finish	OTL1P4KB	70
	<b>Clic Table Lock Set</b> twist and lock into place set includes four components (two locks) for each seam and (8) screws zinc finish 3.5" diameter	OTLCLICZ	150
	<b>Fixed Plate Set (set of 20 plates per box)</b> 3" x 6" heavy-duty 1/8" thick steel plates includes 20 plates and wood screws for each seam (no longer sold individually) Black finish	OTL2PWSB20	330

Typical Configurations



8 sets



5 sets

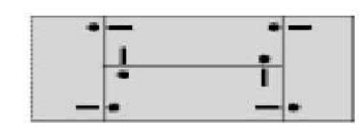

3 sets

### Anti-sag bars



14-gauge rectangular black steel bar mounted under the top  
 all surfaces 54" or longer include top stiffeners with the top pricing

Email [service@symphonytables.com](mailto:service@symphonytables.com) to confirm that the table ganging devices will fit on the top with all other components specified for the table.

# credenzas

# credenzas

For complete credenza model number, insert laminate grade selection:

**M** melamine / low pressure laminate (LPL)

**1** grade 1 laminate (HPL)

**2** grade 2 laminate (HPL)

credenza	dimensions	description	model no.	melamin e list	grade 1 list	grade 2 list
	24 x 36 x 30H	2 door, 1 adj shelves with silver bar pulls	ASCR243630__	4,030	5,260	6,080
	24 x 36 x 36H	2 door, 1 adj shelves with silver bar pulls	ASCR243636__	4,170	5,470	6,330
	24 x 36 x 36H	2 door, 2 drawer, 2 adj shelves with silver bar pulls	ASBC243636__	4,520	5,960	6,920
	24 x 48 x 30H	4 door, 2 adj shelves with silver bar pulls	ASCR244830__	4,380	5,760	6,680
	24 x 48 x 36H	4 door, 2 adj shelves with silver bar pulls	ASCR244836__	4,540	5,990	6,960
	24 x 48 x 36H	4 door, 4 drawer, 2 adj shelves with silver bar pulls	ASBC244836__	4,880	6,480	7,540
	24 x 60 x 30H	4 door, 2 adj shelves with silver bar pulls	ASCR246030__	5,270	6,930	8,040
	24 x 60 x 36H	4 door, 2 adj shelves with silver bar pulls	ASCR246036__	5,460	7,210	8,370
	24 x 60 x 36H	4 door, 4 drawer, 2 adj shelves with silver bar pulls	ASBC246036__	5,800	7,700	8,960
	24 x 72 x 30H	4 door, 2 adj shelves with silver bar pulls	ASCR247230__	5,870	7,800	9,080
	24 x 72 x 36H	4 door, 2 adj shelves with silver bar pulls	ASCR247236__	6,100	8,120	9,460
	24 x 72 x 36H	4 door, 4 drawer, 2 adj shelves with silver bar pulls	ASBC247236__	6,550	8,760	10,230
	24 x 84 x 30H	6 door, 3 adj shelves with silver bar pulls	ASCR248430__	7,630	10,160	11,870
	24 x 84 x 36H	6 door, 3 adj shelves with silver bar pulls	ASCR248436__	7,930	10,580	12,380
	24 x 84 x 36H	6 door, 6 drawer, 3 adj shelves with silver bar pulls	ASBC248436__	8,550	11,450	13,410
	24 x 96 x 30H	6 door, 3 adj shelves with silver bar pulls	ASCR249630__	7,690	10,210	11,920
	24 x 96 x 36H	6 door, 3 adj shelves with silver bar pulls	ASCR249636__	7,990	10,630	12,420
	24 x 96 x 36H	6 door, 6 drawer, 3 adj shelves with silver bar pulls	ASBC249636__	8,590	11,500	13,460

\* credenzas come with silver lock cores

### STOCK MELAMINE (LPL) COLORS:

DESIGNER WHITE, FROSTY WHITE, FASHION GRAY, SLATE GRAY, BLACK, FUSION MAPLE, KENSINGTON MAPLE, MONTICELLO MAPLE, RIVER CHERRY, WILD CHERRY, BLEACHED LEGNO, NEUTRAL TWILL, PRESTIGE WALNUT, SELECT CHERRY, CAFELLE

\* The body of the credenza will be in LPL laminate and the top will be in HPL laminate. LPL laminate is rated for vertical surfaces.

Formica + Wilsonart HPL laminate finish grades listed on page 6-13. For additional laminate grades, contact Symphony

### Credenza options:

Vent with black vent grills, model number **OACREDVENT**, \$60 list per vent

Grommet for wire management on the back of the credenza, model number **OACREDGROM**, \$40 list per grommet

\* touch latch hardware and soft close hinges are available with an upcharge, contact [service@symphonytables.com](mailto:service@symphonytables.com) for pricing

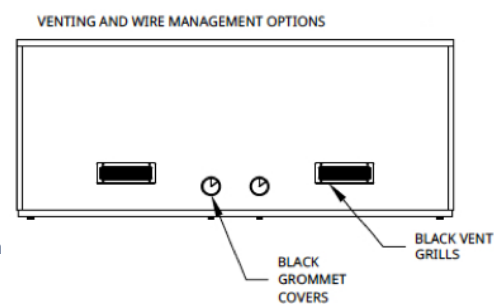

### Credenza standard specifications

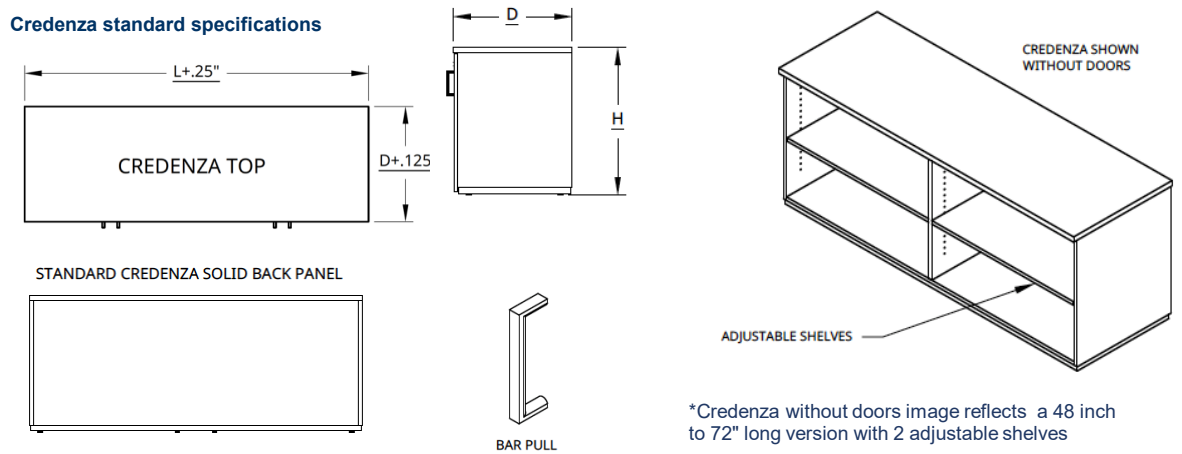

36" L credenza with 2 doors  
\*available in 30"H or 36"H

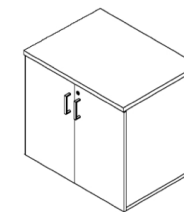

48" - 72" L credenza with 4 doors  
\*available in 30"H or 36"H

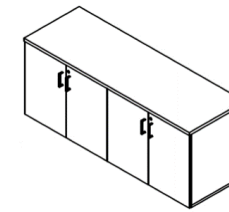

48" - 72" L credenza with 4 doors  
\*available in 30"H or 36"H

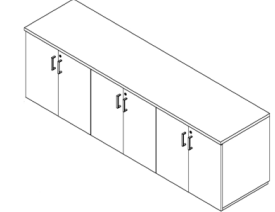

36" L credenza with 2 doors and 2 drawers, 36"H

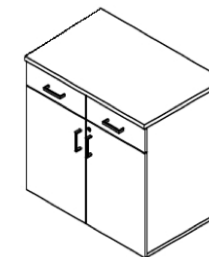

48" - 72" L credenza with 4 doors and 4 drawers, 36"H

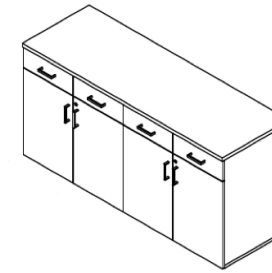

84" - 96" L credenza with 6 doors and 6 drawers, 36"H

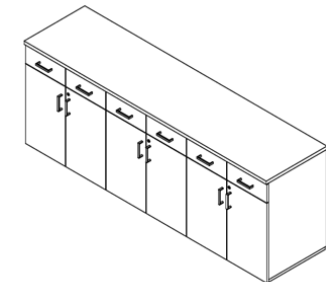

# lectern

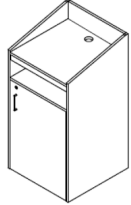
lectern	Description	model no.	laminata grade	list
	laminata lectern	ALLS4SDC242448M	melamine	3,330
	flat top surface	ALLS4SDC2424481	grade 1	4,370
	open shelf	ALLS4SDC2424482	grade 2	5,010

two shelves behind locked hinged door  
wire management holes  
recessed black locking casters (4)  
additional sizes, versions, options,  
configurations available

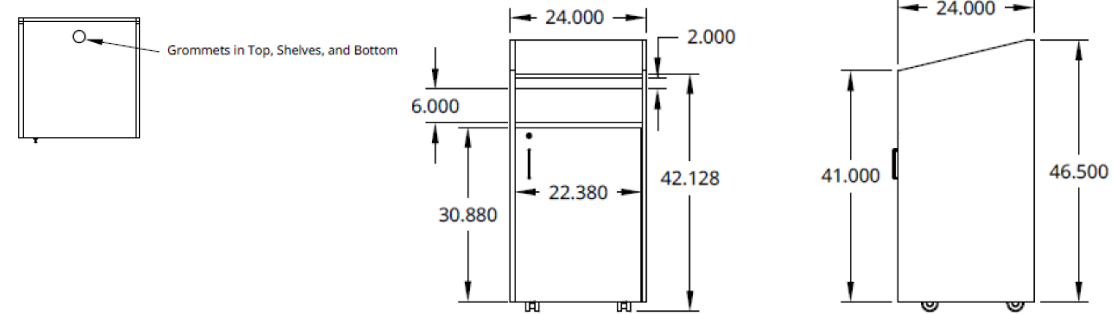

**STOCK MELAMINE (LPL) COLORS:**  
DESIGNER WHITE, FROSTY WHITE, FASHION GRAY, SLATE GRAY, BLACK, FUSION MAPLE, KENSINGTON MAPLE, MONTICELLO MAPLE, RIVER CHERRY, WILD CHERRY, BLEACHED LEGNO, NEUTRAL TWILL, PRESTIGE WALNUT, SELECT CHERRY, CAFELLE

# study carrel and screens



Study carrels, laminata & acrylic screens are available, contact Symphony for pricing and more information

# general information

## Terms of Sale

All prices listed are delivered pricing to the 48 contiguous states. Orders shipped to Hawaii, Alaska, and Puerto Rico ship to the port of embarkation. Product specifications and pricing is based on the information at time of publication. Symphony reserves the right to make changes at any time without notice regarding product specifications and pricing. Terms are Net 30 from the date of shipment (net 10, 1% discount). Prices are subject to change annually for changes in accordance with state contract regulations. All customer/nonstandard products are subject to a fifty percent (50%) advance deposit. There will be a service charge of 1 1/2% per month on all invoices past due. Symphony reserves the right to use its own or commercial carriers for the "best way" to ship, at its sole discretion.

## Quality Standards

Symphony Furniture products meet or exceed applicable ANSI/BIFMA durability and safety standards when properly installed with appropriate size base.

## Warranty

All Symphony products are guaranteed against defect for a period of ten (10) years. Electrical items and height adjustment mechanisms are guaranteed against defect for a period of five (5) years. Symphony will replace or repair (at our discretion) without cost to our customers any item found to be defective as a result of defective material or workmanship. This excludes any item which has been abused or subjected to any use other than that which was originally intended for our product. Any repairs by our customer must receive specific written authorization from Symphony before work is initiated. This warranty is given to the initial purchaser and is valid for as long as the product is owned by the initial purchaser. The warranty, which runs from the date of manufacture, covers defects in materials and craftsmanship found during normal usage of the products during the warranty period. If a product is defective, and if written notice of the defect is given to Symphony within the warranty period, Symphony at its discretion will either repair or replace the defective product with a comparable component or product, or provide a refund of the purchase price. In no event shall liability under this warranty exceed the original purchase price. Warranty on plastic laminates is not covered by Symphony but is covered by laminate manufacturers under their specific warranty only. There are no other warranties expressed or implied. This warranty does not apply to damage caused by a carrier, alterations to the product not expressly authorized by Symphony. Symphony does not warrant the matching of color, grain, or texture except to within commercially acceptable standards. A product will not be considered defective, and Symphony will not be obligated to replace it, if that product is subject to any of Symphony's written planning, installation or user guides, and is not installed or used as recommended.

Please note that all Losa tables and conference/media tables should not be moved as a complete unit after the product has been assembled. If it is moved, then this could result in the tables being "racked" which could also disrupt the top plate and/ or cam lock routing and predrilled holes. This type of damage is not covered under warranty. In order to move a table, you must unassembled the table completely and re-assemble it in the new location.

## Minimum order/Freight Charge

Zone 1 orders less than \$5,000 list (U.S.) - \$200 net  
Zone 2 orders less than \$5,000 list (U.S.) - \$260 net

## Sales Policy

Possession of this price list does not constitute authority to purchase and/or sell products contained herein. All orders are subject to acceptance by Symphony Furniture.

## New Accounts

New accounts can only be established with:

Approval of Symphony sales representative

Valid purchase order

State Resale/Exemption Certificate or order will be charged the appropriate sales tax

Application & credit references

Payment in full (initial orders under \$4,000 list) or 50% deposit in advance

## Taxes

Symphony requires a state Resale/Exemption Certificate on file in our main office. Sales made without a certificate will be charged the appropriate sales tax as required by law.

## Freight Terms

Freight charges will be prepaid on all shipments unless special arrangements have been made. Normal delivery is dock to dock. Special requests, such as inside delivery, lift gate service; residential delivery, etc. are subject to additional charges. All accessorial charges not requested on purchase order will be the responsibility of the consignee. Symphony reserves the right to select the "best way" shipment method and means. Delivery date and times are at the discretion of the carrier within reasonable transit time unless special arrangements have been made between the customer and Symphony.

## Acknowledgements

Every order is acknowledged. Orders will be manufactured and invoiced based upon the information on the acknowledgment. If there is any discrepancy, please notify Symphony immediately. Orders are accepted by Symphony per terms on the acknowledgment. All acknowledgements contain an estimated shipping date. Your order may actually ship earlier than the expected shipping date, depending on the backlog at the time. If you do not want the merchandise earlier than the specified date, please write "Do not ship for arrival before \_\_\_\_\_" on your purchase order.

## Revised Orders

Orders requiring changes to the product or additional options will not incur additional costs unless orders have been processed. Orders revised after being manufactured are subject to additional charges.

## Changes or Cancellations

Orders entered and acknowledged cannot be changed or cancelled without Symphony's consent. The customer is responsible for all costs incurred, and a minimum cancellation or change charge of 25% will be invoiced if an order is cancelled or changed within 15 working days of shipment. Orders for nonstandard products are not cancelable.

## Shipments on Hold

Any shipment placed on hold by customer's request or due to balance owed, will be manufactured per the originally scheduled ship date. Storage charges will begin to accrue 7 days from that date. Any order held by our factory over 30 days will be billed and must be promptly paid even though shipment is held at factory at customer's request.

## Special or Additional Freight Charges

Symphony Furniture reserves the right to charge the following when incurring additional freight costs. Destination changes after product has shipped - \$50.00 plus \$2.00/mile after the first 10 miles. Wait time for delivery of greater than two hours - \$130.00/hour. Trailer drop/switch delivery - \$200.00/trailer. Deliveries Friday (after 3:00pm) through Sunday or Holidays - \$600.00/day. Third party to pick up freight at the terminal - \$200.00.

## Redelivery of Freight

When redelivery of merchandise is required because customer is not ready to accept merchandise, and no notification of this fact is given to the factory at least two weeks prior to the scheduled ship date, the actual costs for freight, restocking and re-handling, plus 5% at the order value, will be billed to the customer.

## Receipt of Order

1. Carefully inspect all incoming items
  2. If an item is damaged, please note the damage on the delivery receipt.
  3. Immediately contact the carrier to request an inspection and their freight claim form.
  4. File the freight claim form with the carrier within five days of receipt.
  5. If any item is missing or is not correct, please contact Symphony immediately.
- Any concealed damages or shortage not reported with 5 business days from delivery shall be the sole responsibility of the customer.

# terms and conditions

## Shipment Damage Claims

Legal title of merchandise passes to the buyer upon acceptance of the carrier. All merchandise is packed to comply with carrier requirements. Shipments should be carefully inspected by the consignee before acceptance and the delivery carrier should be requested to record any damage or shortage. If further damage is found after delivery, immediate inspection by the delivering carrier should be requested. Notification of concealed damages must be made to the delivering carrier within 5 days after delivery of merchandise. Carrier liability ceases after this period. Damaged freight must be kept at the point of delivery in the original packing for inspection by the carrier. Please be advised that if the carrier obtains a clear receipt for shipment, they are no longer responsible for damage or shortages. Please note that electronically signing the carrier's tablet at the time of delivery means that you are accepting the delivery and no damages are being notated. If you see anything that indicates a shipment has been tampered with or shows signs of damage, then ask the driver to report it to the freight company and take pictures.

## Shipment Shortage Claims

Shortage claims reported after 10 days beyond shipment date will not be honored.

## Unopened Shipment Damage Claims

Neither Symphony nor the carrier is responsible for concealed damage claims if shipments are left unopened. Notification of concealed damages must be made to the delivering carrier within 5 days after delivery of merchandise. Refusal to accept an order from the carrier does not relieve you of the responsibility for payment, and may incur additional charges.

## Lost Shipments

Symphony issues a bill of lading to consignee on the date of shipment. If shipment is not received within 20 days of shipment date, notify us. Symphony and the carrier do not assume obligation for lost or damaged shipment claims after 6 months of shipping date.

## Title to Merchandise

Title to merchandise shall pass to the buyer upon delivery by Symphony to the carrier. For purposes of risk or loss, all shipments are F.O.B. factory. Buyer acknowledges that once Symphony delivers the goods to the carrier, title to the goods and risk of loss will pass to the buyer. If the goods are damaged by the carrier while in transit, the buyer has the sole obligation of seeking recourse from the carrier.

## Returns

Symphony will not permit return of materials without written consent if materials shipped are as acknowledged. Return shipments when accepted are subject to a re-handling/restocking charge, in accordance with the state contract after the merchandise is received and inspected. All freight or express charges must be prepaid on return shipments; otherwise, they will not be accepted. Damaged materials and all items specially built to order cannot be returned under any conditions.

## Repair and Replacement

Any labor charges for correcting a manufacturing problem must be submitted and approved before correction is undertaken, if the units are under warranty. Labor charges will not be paid if the estimate was not submitted and approved prior to labor being completed.

## Contact Information

Symphony Furniture, 1720 Mars Hill Road, Suite 8-287, Acworth, GA 30101, GA 30318-1732  
Phone: 866.507.7795  
Fax: 888.683.0007

# table care and maintenance

## Table Care and Maintenance

### Laminate Surfaces, Vinyl & PVC edges

High-pressure laminate is durable and requires minimal maintenance. To clean the surface, use a damp cloth or sponge and a mild soap or detergent. Rinse with clean, clear water. Wipe the entire surface, moving with the pattern and follow with a clean, dry, soft cloth. When a wood edge exists, follow "Wood Edge and Veneer" instructions.

Difficult "stains" such as coffee or tea can be removed using a mild household cleaner/detergent and a soft bristle brush, repeating as necessary. If stain persists, use a paste of baking soda & water and apply with a soft bristled brush. Light scrubbing for 10-20 strokes should remove most stains (excessive scrubbing or exerting too much force may damage the surface, especially gloss finish surfaces). Any remaining stains may require the use of undiluted household bleach or nail polish remover. Apply to stain and let stand no longer than two minutes. Rinse thoroughly with warm water & wipe dry. Step may be repeated. However, prolonged exposure of bleach to surface will cause discoloration.

Abrasive pads, scouring powders or cleansers may permanently dull & scratch the surface making the laminate susceptible to staining. Harsh chemicals such as oven, toilet or drain cleaners will etch & discolor laminates. If spills of these products occur, remove immediately, rinse thoroughly, and wipe dry.

High pressure laminates have high heat resistance, however exposure to temperatures greater than 135 degrees C (275 degrees F) is not recommended. Prolonged exposure to temperatures above 65 degrees C (150 degrees F) may result in separation of the laminate from the substrate. Protect the surface from heat generating appliances by using a trivet or insulating pad.

Do not use sharp objects directly on the laminate surface. A counter saver or chopping block is recommended.

HP laminate have excellent impact resistance. However, heavy objects dropped on the surface may chip or crack the laminate.

### Powder Coated Metal

Clean with a mild soap solution and rinse with clean clear water. Wipe the entire surface and follow with a clean, dry cloth to buff dry.

### Chromed Metal

Clean with a wet cloth or window cleaner. For scuff marks or heavy soiling, apply a non-abrasive automotive chrome polish as directed.

### Mechanical Parts

Clean any lint or debris from the moving parts of the tilt or folding mechanisms. Do not apply any lubricant.



# environmental statement and solutions

## Environmental Statement & Solutions

Everyone at Symphony shares the concern of protecting the environment. We use environmentally friendly materials in our products and processes wherever possible. Environmental awareness is something we strive to incorporate into every aspect of our lives. Recycled/recyclable packing/shipping materials are used whenever possible. All plastic, cardboard, scrap metal (steel, stainless steel, & aluminum), used oil, and wood pallets accumulated from the manufacturing process are recycled. All our marketing materials are printed on recycled/recyclable paper.

Symphony is committed to bringing you the designs & solutions needed for your project but also dedicated to preserving the Earth's natural resources for the future.

### Surface Core or Substrate

Standard particleboard core

100% pre-consumer recycled wood fiber particle board certified by Scientific Certification Systems (SCS).

Particleboard is at least 90% wood fiber by weight.

Forest Stewardship Council (FSC); mixed credit available (optional).

Meets California Air Resources Board (CARB) Regulation 93120.2, Phase 1 emissions limits No Added Urea-Formaldehyde (NAUF) Particleboard (optional)

100% pre-consumer recycled wood fiber particle board certified by Scientific

Certification Systems (SCS) Particleboard is at least 90% wood fiber by weight

Forest Stewardship Council (FSC) Mixed Credit Available (optional)

Meets California Air Resources Board (CARB) Regulation 93120.2, Phase 1 emissions limits

No added urea-formaldehyde (NAUF); SCS certified.

Collaborative for High Performance Schools (CHPS) Section 01350 Compliant

Environmentally Preferable Product (EPP) Certified by the Composite Panel Association

### Surface Material

High Pressure Laminate (HPL)

Wilsonart, Formica, Nevamar and Pionite laminates are GREENGUARD Indoor Air Quality Certified®

Wilsonart, Formica, and Pionite laminates are GREENGUARD for Children and Schools Certified®

### Adhesives

Water based adhesive

Low VOC emissions

Does not contain urea-formaldehyde

### Edge Materials

ABS Plastic edge - 2mm ABS plastic edges are available in an array of standard colors

ABS is a recyclable plastic, unlike PVC material

Chlorine Free Polymer can be incinerated

Ecologically responsible chlorine-free polymer may be recycled or incinerated with general wood waste, reducing the amount going into landfills

Urethane edge

Urethane is comprised of approximately 65% refined vegetable oil by weight.

Vegetable oil is a rapidly renewable, natural material

Extreme durability results in a longer lifespan than surfaces made from other materials.

### Bases

Zoey

57% initial recycled content

99% recyclable

Polished aluminum environmentally friendly alternative to polished chrome Standards collection

Produced with a chemical vs. electrical deposition, and encompasses a chemical reaction to metal (ferrous) material

General

Most bases recyclable

Powder coat much more environmentally friendly alternative than liquid metal finishing (over-spray collections increase utilization to over 95%)

For LEED-CI V2.0 Credit and Point Information, visit [www.symphonytables.com](http://www.symphonytables.com)



---

# SYMPHONY®

table environments

866-507-7795

fax 888-683-0007

[SERVICE@SYMPHONYTABLES.COM](mailto:SERVICE@SYMPHONYTABLES.COM)

[symphonytables.com](http://symphonytables.com)