

---

# SYMPHONY®

## TABLE ENVIRONMENTS

### 2022 PRICE LIST

version #1.3

# table of contents

table of contents	
<b>Essential Information</b>	4
<b>Tables</b>	
Losa	6
Sala occasional	14
<b>Surfaces</b>	
surface and edge overview	16
edge profile overview	17
surface shapes, dimensions, seating capacity	18
Wilsonart laminate finishes by number	20
Wilsonart laminate finishes by name	22
Formica laminate finishes by number	24
Formica laminate finishes by name	26
PVEA and PVKN round, square, squircle, rectangle	28
PVEA and PVKN conference: boat, racetrack, oval, arc trapezoid, arc rectangle	30
PVEA and PVKN media tops: half arc end, half boat, bullet, trapezoid	32
PVEA quarter round, half round, crecent, trapezoid, corner-angled, corner-curved, corner-extended curved front, corner-120 degree, wedge	33
VNEA round, square, squircle, rectangle	34
VNEA conference: boat, racetrack, oval	36
VNEA media tops: half arc end, half boat, bullet, trapezoid	37
PVEA, PVRC, PVKN and PVKR laptop & occasional	38
<b>Bases</b>	
T fixed, single column	40
fixed, double column	42
nesting	43
nesting adjustable height	46
adjustable height	47
C fixed	54
nesting	56
adjustable height	58
X and Y fixed	60
flip	68
adjustable height	71
four column	72
Una personal workstation fixed and adjustable height	74
disc fixed	80
adjustable height	82
laptop and occasional	84
conference, under table media base and media walls	87
post and frame bases	108
<b>Power/data + Wire Management</b>	
power supply location chart	118
power/data modules (in alphabetical order)	120
wire management	140
grommets	142
modesty panels	144
<b>Accessories</b>	
locks	147
credenzas	148
lectern and misc accessories	150
<b>General Information</b>	
Terms & Conditions	154
Table Care and Maintenance	157
Environmental Statement & Solutions	158

# essential information

## Minimum order / Freight charge

Orders for \$5,000 or more list (contiguous U.S.): freight and minimum order charges included

Orders less than \$5000 list (contiguous U.S.)

Zone 1 \$200 net

Zone 2 \$260 net

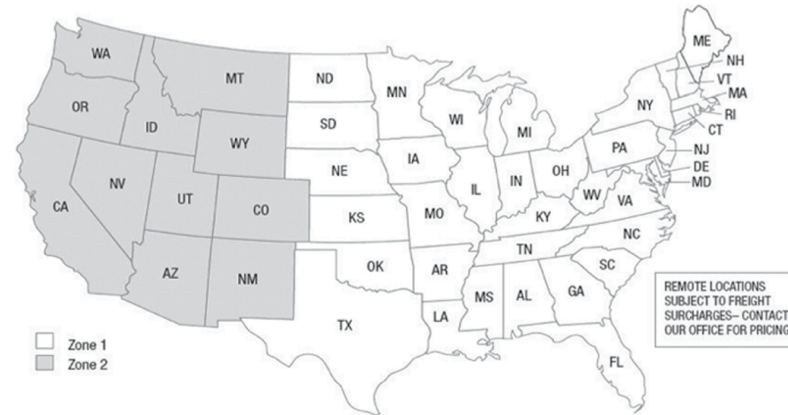

## Special Charges

Custom metal finish: contact [service@symphonytables.com](mailto:service@symphonytables.com) for a quote

### Grain match fees for 2 piece tops with a wood grain laminate

Use the following charges for tops up to 144" long:

OTGRMTCH36144\_GRA Grain match option for 36 inch deep 2 piece tops (up to 144 inches long) with grade A woodgrain laminate - **\$200 list**  
 OTGRMTCH36144\_GRB Grain match option for 36 inch deep 2 piece tops (up to 144 inches long) with grade B woodgrain laminate - **\$230 list**  
 OTGRMTCH36144\_GRC Grain match option for 36 inch deep 2 piece tops (up to 144 inches long) with grade C woodgrain laminate - **\$310 list**

OTGRMTCH42144\_GRA Grain match option for 42 inch deep 2 piece tops (up to 144 inches long) with grade A woodgrain laminate - **\$230 list**  
 OTGRMTCH42144\_GRB Grain match option for 42 inch deep 2 piece tops (up to 144 inches long) with grade B woodgrain laminate - **\$280 list**  
 OTGRMTCH42144\_GRC Grain match option for 42 inch deep 2 piece tops (up to 144 inches long) with grade C woodgrain laminate - **\$350 list**

OTGRMTCH48144\_GRA Grain match option for 48 inch deep 2 piece tops (up to 144 inches long) with grade A woodgrain laminate - **\$260 list**  
 OTGRMTCH48144\_GRB Grain match option for 48 inch deep 2 piece tops (up to 144 inches long) with grade B woodgrain laminate - **\$310 list**  
 OTGRMTCH48144\_GRC Grain match option for 48 inch deep 2 piece tops (up to 144 inches long) with grade C woodgrain laminate - **\$410 list**

OTGRMTCH60144\_GRA Grain match option for 60 inch deep 2 piece tops (up to 144 inches long) with grade A woodgrain laminate - **\$330 list**  
 OTGRMTCH60144\_GRB Grain match option for 60 inch deep 2 piece tops (up to 144 inches long) with grade B woodgrain laminate - **\$390 list**  
 OTGRMTCH60144\_GRC Grain match option for 60 inch deep 2 piece tops (up to 144 inches long) with grade C woodgrain laminate - **\$510 list**

Use the following charges for tops up to 192" long:

OTGRMTCH48192\_GRA Grain match option for 48 inch deep 2 piece tops (up to 192 inches long) with grade A woodgrain laminate - **\$350 list**  
 OTGRMTCH48192\_GRB Grain match option for 48 inch deep 2 piece tops (up to 192 inches long) with grade B woodgrain laminate - **\$410 list**  
 OTGRMTCH48192\_GRC Grain match option for 48 inch deep 2 piece tops (up to 192 inches long) with grade C woodgrain laminate - **\$540 list**

OTGRMTCH60192\_GRA Grain match option for 60 inch deep 2 piece tops (up to 192 inches long) with grade A woodgrain laminate - **\$430 list**  
 OTGRMTCH60192\_GRB Grain match option for 60 inch deep 2 piece tops (up to 192 inches long) with grade B woodgrain laminate - **\$520 list**  
 OTGRMTCH60192\_GRC Grain match option for 60 inch deep 2 piece tops (up to 192 inches long) with grade C woodgrain laminate - **\$670 list**

## Lead Time

varies - please email [service@symphonytables.com](mailto:service@symphonytables.com) to confirm lead time

Please send purchase orders to [service@symphonytables.com](mailto:service@symphonytables.com)

## Symphony Contact Information

# tables

# tables

## Losa 1 piece seated height

For complete model number:

1. insert 2 letter edge code:  
**PV** - 1.25" thick 3mm edge  
**LT** - 1.625" thick self edge laminate

2. insert 1 letter laminate grade code:  
**A** - grade A laminate  
**B** - grade B laminate  
**C** - grade C laminate

### 30"H Seated Height Table - One piece top

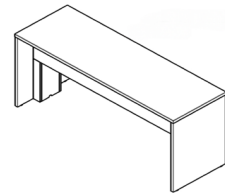

\*24" deep Losa tables with a 1 piece top come standard with 1 stretcher centered under the top. To order an additional stretcher so that power can be centered and concealed between the 2 stretchers, please use model # **OBLOSSTR241PC** - \$0 list

\*\*30" & 36" deep Losa tables with a 1 piece top come standard with 2 stretchers centered under the top. To order only 1 single stretcher centered under the table to allow for more kneespace, please use model # **OBLOSSTR30361PC** - \$0 list

\*shown with optional wire management 3-sided chase

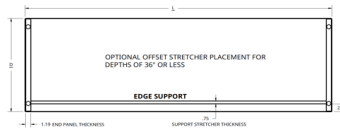

#### Offset single stretcher placement option for 24"-36" deep tops:

model # **OBLOSSTROSP** - \$0 list

\*\* for 30" and 36" deep tops, please also indicate model number **OBLOSSTR30361PC** on your PO for a single stretcher instead of 2 stretchers - \$0 list

#### Wire Management 3-Sided Chase options:

Losa 3 sided laminate wire management chase with latches for 1 end panel base  
 Seated height chase (16.56"H) model # **OBLOSWM3SCE30** - \$330 list

Losa 3 sided laminate wire management chase with latches for both end panel bases  
 Seated height chase (16.56"H) model # **OBLOSWM3SC2E30** - \$660 list

Losa 3 sided laminate wire management chase with latches for 1 middle panel base  
 Seated height chase (16.56"H) model # **OBLOSWM3SCM30** - \$330 list

#### Wire Management Stretcher options:

Losa wire management mouse hole (1) stretcher at the top / center  
 model # **OBLOSWMHHS** - \$20 list

Losa wire management notched cut out for power supply (1) stretcher at top / center  
 model # **OBLOSWMNCO** - \$60 list

#### Wire Management End Panel options:

Losa wire management mouse hole (1) in the end panel at the top / center  
 model # **OBLOSWMHET** - \$20 list

Losa wire management mouse hole (1) in the end panel at the bottom / center  
 model # **OBLOSWMHEB** - \$20 list

#### Full Height Stretcher Option - 1 piece top:

- (1) full height stretcher centered under the top - model # **OBLOS1PCFHS1** - \$360 list
- (2) full height stretchers centered under the top - model # **OBLOS1PCFHS2** - \$730 list

Please contact [service@symphonytables.com](mailto:service@symphonytables.com) to make sure that your power and/or wire management solution will work with the Losa table specification. We are able to modify this table with a custom solution to fit your projects needs.

# tables

## Losa 1 piece seated height

Formica + Wilsonart HPL laminate finish grades listed on pages 20-27. For additional laminate grades, contact Symphony.

dimensions	model no.	PVA 3mm PVC Grade A list	PVB 3mm PVC Grade B list	PVC 3mm PVC Grade C list	LTA 1-5/8" laminate self edge Grade A list	LTB 1-5/8" laminate self edge Grade B list	LTC 1-5/8" laminate self edge Grade C list
24 x 48*	TLLOS24048S	1,620	1,730	1,960	1,850	1,900	2,100
24 x 54*	TLLOS24054S	1,630	1,740	1,970	1,930	1,970	2,210
24 x 60*	TLLOS24060S	1,640	1,750	1,980	1,980	2,050	2,240
24 x 66*	TLLOS24066S	1,720	1,830	2,090	2,040	2,090	2,340
24 x 72*	TLLOS24072S	1,730	1,840	2,100	2,050	2,150	2,390
24 x 84*	TLLOS24084S	1,900	2,040	2,330	2,170	2,220	2,490
24 x 96*	TLLOS24096S	1,910	2,050	2,340	2,270	2,330	2,620
30 x 48**	TLLOS30048S	1,750	1,820	2,060	1,950	2,010	2,230
30 x 54**	TLLOS30054S	1,760	1,830	2,090	2,050	2,090	2,340
30 x 60**	TLLOS30060S	1,770	1,840	2,100	2,090	2,130	2,400
30 x 66**	TLLOS30066S	1,840	1,970	2,260	2,200	2,260	2,530
30 x 72**	TLLOS30072S	1,850	1,980	2,270	2,230	2,280	2,560
30 x 84**	TLLOS30084S	2,180	2,320	2,650	2,480	2,530	2,840
30 x 96**	TLLOS30096S	2,190	2,330	2,660	2,570	2,630	2,950
36 x 48**	TLLOS36048S	1,950	2,060	2,320	2,090	2,200	3,370
36 x 54**	TLLOS36054S	2,040	2,130	2,410	2,180	2,290	3,560
36 x 60**	TLLOS36060S	2,100	2,210	2,500	2,260	2,370	3,760
36 x 66**	TLLOS36066S	2,180	2,280	2,570	2,340	2,440	3,960
36 x 72**	TLLOS36072S	2,200	2,330	2,630	2,550	2,550	4,140
36 x 84**	TLLOS36084S	2,340	2,520	2,840	2,700	2,700	4,480
36 x 96**	TLLOS36096S	2,350	2,530	2,860	2,780	2,780	4,660
42 x 48	TLLOS42048S	2,010	2,110	2,380	2,150	2,260	2,550
42 x 54	TLLOS42054S	2,090	2,200	2,480	2,240	2,350	2,660
42 x 60	TLLOS42060S	2,170	2,270	2,560	2,330	2,430	2,770
42 x 66	TLLOS42066S	2,230	2,350	2,660	2,410	2,520	2,860
42 x 72	TLLOS42072S	2,260	2,390	2,700	2,630	2,670	2,980
42 x 84	TLLOS42084S	2,390	2,510	2,870	2,780	2,830	3,160
42 x 96	TLLOS42096S	2,400	2,520	2,880	2,930	2,980	3,360
48 x 54	TLLOS48054S	2,210	2,290	2,620	2,480	2,520	2,830
48 x 60	TLLOS48060S	2,220	2,370	2,720	2,560	2,630	2,950
48 x 66	TLLOS48066S	2,240	2,380	2,820	2,660	2,720	3,060
48 x 72	TLLOS48072S	2,260	2,390	2,980	2,990	3,040	3,420
48 x 84	TLLOS48084S	2,440	2,510	2,870	3,060	3,110	3,500
48 x 96	TLLOS48096S	2,460	2,520	2,880	3,110	3,170	3,580
54 x 60	TLLOS54060S	3,120	3,180	3,590	3,360	3,410	3,860
54 x 66	TLLOS54066S	3,230	3,280	3,710	3,470	3,520	3,990
54 x 72	TLLOS54072S	3,320	3,390	3,830	3,660	3,720	4,220
54 x 84	TLLOS54084S	3,360	3,410	3,860	3,700	3,750	4,280
54 x 96	TLLOS54096S	3,380	3,430	3,880	3,720	3,770	4,300
60 x 66	TLLOS60066S	3,510	3,620	4,040	3,740	3,850	4,320
60 x 72	TLLOS60072S	3,600	3,710	4,160	3,930	4,050	4,570
60 x 84	TLLOS60084S	3,620	3,730	4,180	3,970	4,090	4,600
60 x 96	TLLOS60096S	3,650	3,760	4,210	3,990	4,110	4,630



# tables

## Losa 1 piece counter and bar height

For complete model number:  
 1. insert 1 letter height code:  
**C** - 36" counter height  
**B** - 42" bar height

2. insert 2 letter edge code:  
**PV** - 1.25" thick 3mm edge  
**LT** - 1.625" thick self edge laminate

3. insert 1 letter laminate grade code:  
**A** - grade A laminate  
**B** - grade B laminate  
**C** - grade C laminate

### 36"H Counter or 42"H Bar Height Table - One piece top

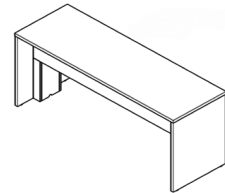

\*24" deep Losa tables with a 1 piece top come standard with 1 stretcher centered under the top. To order an additional stretcher so that power can be centered and concealed between the 2 stretchers, please use model # **OBLOSSTR241PC** - \$0 list

\*\*30" & 36" deep Losa tables with a 1 piece top come standard with 2 stretchers centered under the top. To order only 1 single stretcher centered under the table to allow for more kneespace, please use model # **OBLOSSTR30361PC** - \$0 list

\*shown with optional wire management 3-sided chase

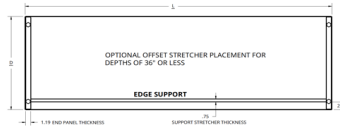

#### Offset single stretcher placement option for 24"-36" deep tops:

model # **OBLOSSTROSP** - \$0 list

\*\* for 30" and 36" deep tops, please also indicate model number **OBLOSSTR30361PC** on your PO for a single stretcher instead of 2 stretchers - \$0 list

#### Wire Management 3-Sided Chase options:

Losa 3 sided laminate wire management chase with latches for 1 end panel base  
 Counter height chase (22.56"H) model # **OBLOSWM3SCE36** - \$340 list  
 Bar height chase (28.56"H) model # **OBLOSWM3SCE42** - \$360 list

Losa 3 sided laminate wire management chase with latches for both end panel bases  
 Counter height chase (22.56"H) model # **OBLOSWM3SC2E36** - \$680 list  
 Bar height chase (28.56"H) model # **OBLOSWM3SC2E42** - \$730 list

Losa 3 sided laminate wire management chase with latches for 1 middle panel base  
 Counter height chase (22.56"H) model # **OBLOSWM3SCM36** - \$340 list  
 Bar height chase (28.56"H) model # **OBLOSWM3SCM42** - \$360 list

#### Wire Management Stretcher options:

Losa wire management mouse hole (1) stretcher at the top / center  
 model # **OBLOSWMHHS** - \$20 list

Losa wire management notched cut out for power supply (1) stretcher at top / center  
 model # **OBLOSWMNCO** - \$60 list

#### Wire Management End Panel options:

Losa wire management mouse hole (1) in the end panel at the top / center  
 model # **OBLOSWMHET** - \$20 list

Losa wire management mouse hole (1) in the end panel at the bottom / center  
 model # **OBLOSWMHEB** - \$20 list

#### Full Height Stretcher Option - 1 piece top:

(1) full height stretcher centered under the top - model # **OBLOS1PCFHS1** - \$360 list  
 (2) full height stretchers centered under the top - model # **OBLOS1PCFHS2** - \$730 list

Please contact [service@symphonytables.com](mailto:service@symphonytables.com) to make sure that your power and/or wire management solution will work with the Losa table specification. We are able to modify this table with a custom solution to fit your projects needs.

# tables

## Losa 1 piece counter and bar height

Formica + Wilsonart HPL laminate finish grades listed on pages 20-27. For additional laminate grades, contact Symphony.

dimensions	model no.	PVA 3mm PVC Grade A list	PVB 3mm PVC Grade B list	PVC 3mm PVC Grade C list	LTA 1-5/8" laminate self edge Grade A list	LTB 1-5/8" laminate self edge Grade B list	LTC 1-5/8" laminate self edge Grade C list
24 x 48*	TLLOS24048	1,730	1,840	2,100	1,970	2,080	2,320
24 x 54*	TLLOS24054	1,740	1,850	2,110	2,070	2,180	2,420
24 x 60*	TLLOS24060	1,750	1,870	2,120	2,130	2,260	2,560
24 x 66*	TLLOS24066	1,830	1,960	2,230	2,180	2,290	2,620
24 x 72*	TLLOS24072	1,840	1,970	2,240	2,200	2,320	2,660
24 x 84*	TLLOS24084	2,040	2,180	2,510	2,320	2,370	2,720
24 x 96*	TLLOS24096	2,050	2,190	2,520	2,410	2,460	2,780
30 x 48**	TLLOS30048	1,850	1,990	2,290	2,150	2,200	2,520
30 x 54**	TLLOS30054	1,870	2,010	2,310	2,240	2,310	2,640
30 x 60**	TLLOS30060	1,880	2,020	2,320	2,310	2,370	2,670
30 x 66**	TLLOS30066	1,970	2,120	2,430	2,380	2,420	2,790
30 x 72**	TLLOS30072	1,980	2,130	2,440	2,440	2,510	2,840
30 x 84**	TLLOS30084	2,320	2,490	2,840	2,660	2,720	3,110
30 x 96**	TLLOS30096	2,330	2,500	2,850	2,710	2,770	3,170
36 x 48**	TLLOS36048	2,080	2,120	2,400	2,220	2,280	2,590
36 x 54**	TLLOS36054	2,170	2,210	2,510	2,330	2,380	2,710
36 x 60**	TLLOS36060	2,240	2,290	2,610	2,410	2,480	2,820
36 x 66**	TLLOS36066	2,320	2,380	2,700	2,500	2,550	2,930
36 x 72**	TLLOS36072	2,330	2,480	2,810	2,550	2,610	2,980
36 x 84**	TLLOS36084	2,500	2,670	3,040	2,870	2,940	3,290
36 x 96**	TLLOS36096	2,510	2,700	3,080	2,990	3,060	3,320
42 x 48	TLLOS42048	2,120	2,190	2,480	2,290	2,350	2,670
42 x 54	TLLOS42054	2,220	2,280	2,590	2,390	2,440	2,790
42 x 60	TLLOS42060	2,310	2,370	2,680	2,490	2,540	2,900
42 x 66	TLLOS42066	2,380	2,440	2,870	2,570	2,640	3,000
42 x 72	TLLOS42072	2,390	2,540	2,880	2,630	2,670	3,030
42 x 84	TLLOS42084	2,540	2,700	3,100	2,970	3,010	3,400
42 x 96	TLLOS42096	2,550	2,710	3,110	3,040	3,090	3,450
48 x 54	TLLOS48054	2,240	2,310	2,620	2,420	2,480	2,820
48 x 60	TLLOS48060	2,340	2,400	2,710	2,520	2,560	2,940
48 x 66	TLLOS48066	2,380	2,410	2,740	2,610	2,660	2,980
48 x 72	TLLOS48072	2,390	2,540	2,880	2,990	3,040	3,420
48 x 84	TLLOS48084	2,570	2,700	2,980	3,060	3,110	3,500
48 x 96	TLLOS48096	2,590	2,710	3,110	3,110	3,170	3,580
54 x 60	TLLOS54060	3,320	3,390	3,830	3,580	3,630	4,130
54 x 66	TLLOS54066	3,440	3,500	3,970	3,710	3,750	4,280
54 x 72	TLLOS54072	3,550	3,600	4,100	3,760	3,830	4,330
54 x 84	TLLOS54084	3,580	3,630	4,130	3,820	3,860	4,390
54 x 96	TLLOS54096	3,610	3,660	4,160	3,830	3,880	4,410
60 x 66	TLLOS60066	3,720	3,770	4,250	3,980	4,030	4,550
60 x 72	TLLOS60072	3,830	3,870	4,360	4,050	4,100	4,610
60 x 84	TLLOS60084	3,850	3,910	4,410	4,090	4,140	4,650
60 x 96	TLLOS60096	3,880	3,950	4,430	4,160	4,210	4,690

# tables

## Losa 2 & 3 piece seated height

# tables

## Losa 2 & 3 piece seated height

For complete model number:

1. insert 2 letter edge code:

**PV** - 1.25 thick 3mm edge  
**LT** - 1.625" thick self edge laminate

2. insert 1 letter laminate grade code:

**A** - grade A laminate  
**B** - grade B laminate  
**C** - grade C laminate

Formica + Wilsonart HPL laminate finish grades listed on pages 20-27. For additional laminate grades, contact Symphony.

### 30" Seated Height - Two or Three piece tops

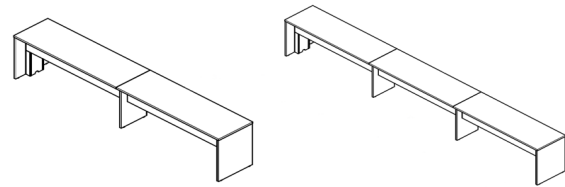

\*24" deep Losa tables with a 2 or 3 piece top come standard with 1 stretcher centered under each half of the top. To order an additional stretchers so that power can be centered and concealed between the 2 stretchers, please use model # **OBLOSSTR242PC** (2 piece top) or **OBLOSSTR243pc** (3 piece top) - \$0 list

\*\*30" & 36" deep Losa tables with a 2 or 3 piece top come standard with 2 stretchers centered under each piece of the top. To order only 1 single stretcher centered under the table to allow for more kneespace, please use model # **OBLOSSTR30362PC** (2 piece top) or **OBLOSSTR30363PC** (3 piece)- \$0 list

\*shown with optional wire management 3-sided chase

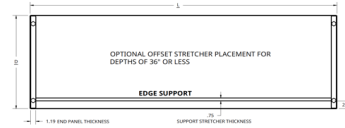

#### Offset single stretcher placement option for 24"-36" deep tops:

model # **OBLOSSTROSP** - \$0 list

\*\* for 30" and 36" deep tops, please also indicate model number **OBLOSSTR30361PC** on your PO for a single stretcher instead of 2 stretchers - \$0 list

#### Wire Management 3-Sided Chase options:

Losa 3 sided laminate wire management chase with latches for 1 end panel base Seated height chase (16.56"H) model # **OBLOSWM3SCE30** - \$330 list

Losa 3 sided laminate wire management chase with latches for both end panel bases Seated height chase (16.56"H) model # **OBLOSWM3SC2E30** - \$660 list

Losa 3 sided laminate wire management chase with latches for 1 middle panel base Seated height chase (16.56"H) model # **OBLOSWM3SCM30** - \$330 list

#### Wire Management Stretcher options:

Losa wire management mouse hole (1) stretcher at the top / center model # **OBLOSWMHHS** - \$20 list

Losa wire management notched cut out for power supply (1) stretcher at top / center model # **OBLOSWMNCO** - \$60 list

#### Wire Management End Panel options:

Losa wire management mouse hole (1) in the end panel at the top / center model # **OBLOSWMHET** - \$20 list

Losa wire management mouse hole (1) in the end panel at the bottom / center model # **OBLOSWMHEB** - \$20 list

#### Full Height Stretcher Option - 2 piece top:

- (1) full height stretcher centered under each half of the 2 piece top- model # **OBLOS2PCFHS2** - \$500 list
- (2) full height stretchers centered under each half of the 2 piece top - model # **OBLOS2PCFHS4** - \$970 list

#### Full Height Stretcher Option - 3 piece top:

- (1) full height stretcher centered under each piece of the 3 piece top - model # **OBLOS3PCFHS3** - \$940 list
- (2) full height stretchers centered under each piece of the 3 piece top - model # **OBLOS3PCFHS6** - \$1870 list

2 or 3 piece top	dimensions	model no.	PVA 3mm PVC			LTA		LTB		LTC
			Grade A list	Grade B list	Grade C list	1-5/8" laminate self edge Grade A list	1-5/8" laminate self edge Grade B list	1-5/8" laminate self edge Grade C list		
2	24 x 120*	TLLOS24120S	3,250	3,360	3,690	3,600	3,650	3,980		
2	24 x 144*	TLLOS24144S	3,580	3,700	4,070	3,800	3,960	4,330		
2	24 x 192*	TLLOS24192S	4,210	4,330	4,850	4,500	4,660	5,190		
3	24 x 216*	TLLOS24216S	5,090	5,200	5,790	5,410	5,590	6,170		
3	24 x 240*	TLLOS24240S	5,410	5,520	6,170	5,780	5,940	6,590		
2	30 x 120**	TLLOS30120S	3,670	3,770	4,150	4,050	4,110	4,480		
2	30 x 144**	TLLOS30144S	4,310	4,420	4,840	4,540	4,710	5,120		
2	30 x 192**	TLLOS30192S	5,010	5,120	5,680	5,320	5,490	6,050		
3	30 x 216**	TLLOS30216S	5,630	5,750	6,380	5,980	6,150	6,800		
3	30 x 240**	TLLOS30240S	5,980	6,090	6,800	6,370	6,530	7,260		
2	36 x 120**	TLLOS36120S	4,050	4,150	4,540	4,440	4,500	5,360		
2	36 x 144**	TLLOS36144S	4,460	4,570	4,980	4,880	4,930	5,750		
2	36 x 192**	TLLOS36192S	5,360	5,470	6,050	5,680	5,840	7,660		
3	36 x 216**	TLLOS36216S	5,980	6,110	6,740	6,360	6,510	8,610		
3	36 x 240**	TLLOS36240S	6,360	6,470	7,180	6,740	6,920	9,560		
2	42 x 120	TLLOS42120S	4,510	4,620	5,050	4,940	4,990	5,430		
2	42 x 144	TLLOS42144S	4,840	4,960	5,430	5,460	5,500	5,980		
2	42 x 192	TLLOS42192S	6,000	6,220	6,160	6,360	6,550	7,290		
3	42 x 216	TLLOS42216S	6,680	6,790	7,510	7,080	7,250	8,000		
3	42 x 240	TLLOS42240S	7,080	7,180	8,000	7,540	7,700	8,550		
2	48 x 120	TLLOS48120S	4,510	4,620	5,050	4,940	4,990	5,430		
2	48 x 144	TLLOS48144S	4,840	4,960	5,430	5,460	5,500	5,980		
2	48 x 192	TLLOS48192S	6,130	6,270	6,920	6,490	6,550	7,360		
3	48 x 216	TLLOS48216S	6,680	6,840	7,570	7,080	7,250	8,050		
3	48 x 240	TLLOS48240S	7,080	8,320	8,050	7,540	7,700	8,590		
2	54 x 120	TLLOS54120S	5,690	5,850	6,390	6,090	6,260	6,860		
2	54 x 144	TLLOS54144S	5,950	6,110	6,700	6,380	6,550	7,230		
2	54 x 192	TLLOS54192S	6,900	7,070	7,840	7,480	7,660	8,550		
3	54 x 216	TLLOS54216S	7,960	8,010	8,930	8,650	8,710	9,780		
3	54 x 240	TLLOS54240S	8,440	8,490	9,520	9,210	9,260	10,440		
2	60 x 120	TLLOS60120S	5,960	6,080	6,620	6,370	6,480	7,100		
2	60 x 144	TLLOS60144S	6,230	6,340	6,920	6,670	6,780	7,440		
2	60 x 192	TLLOS60192S	7,180	7,290	8,060	7,760	7,870	8,760		
3	60 x 216	TLLOS60216S	8,230	8,340	9,270	8,930	9,040	10,110		
3	60 x 240	TLLOS60240S	8,720	8,820	9,850	9,480	9,600	10,780		

Please contact [service@symphonytables.com](mailto:service@symphonytables.com) to make sure that your power and/or wire management solution will work with the Losa table specification. We are able to modify this table with a custom solution to fit your projects needs.

**Grain match fees** for 2 piece woodgrain laminate tops are located on page 4 of the price list. For grain match fees on 3-piece tops, please email [service@symphonytables.com](mailto:service@symphonytables.com). This is for the top only, not all components of the Losa table.

# tables

## Losa 2 & 3 piece counter and bar height

For complete model number:  
 1. insert 1 letter height code:  
**C** - 36" counter height  
**B** - 42" bar height

2. insert 2 letter edge code:  
**PV** - 1.25 thick 3mm edge  
**LT** - 1.625" thick self edge laminate

3. insert 1 letter laminate grade code:  
**A** - grade A laminate  
**B** - grade B laminate  
**C** - grade C laminate

### 36" Counter Height and 42" Bar Height - Two or Three piece tops

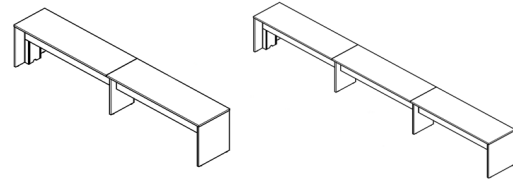

\*24" deep Losa tables with a 2 or 3 piece top come standard with 1 stretcher centered under each half of the top. To order an additional stretchers so that power can be centered and concealed between the 2 stretchers, please use model # **OBLOSSTR242PC** (2 piece top) or **OBLOSSTR243pc** (3 piece top) - \$0 list

\*\*30" & 36" deep Losa tables with a 2 or 3 piece top come standard with 2 stretchers centered under each piece of the top. To order only 1 single stretcher centered under the table to allow for more kneespace, please use model # **OBLOSSTR30362PC** (2 piece top) or **OBLOSSTR30363PC** (3 piece)- \$0 list

#### Offset single stretcher placement option for 24"-36" deep tops:

model # **OBLOSSTROSP** - \$0 list

\*\*for 30" and 36" deep tops, please also indicate model number **OBLOSSTR30361PC** on your PO for a single stretcher instead of 2 stretchers - \$0 list

#### Wire Management 3-Sided Chase options:

Losa 3 sided laminate wire management chase with latches for 1 end panel base  
 Counter height chase (22.56"H) model # **OBLOSWM3SCE36** - \$340 list  
 Bar height chase (28.56"H) model # **OBLOSWM3SCE42** - \$360 list

Losa 3 sided laminate wire management chase with latches for both end panel bases  
 Counter height chase (22.56"H) model # **OBLOSWM3SC2E36** - \$680 list  
 Bar height chase (28.56"H) model # **OBLOSWM3SC2E42** - \$730 list

Losa 3 sided laminate wire management chase with latches for 1 middle panel base  
 Counter height chase (22.56"H) model # **OBLOSWM3SCM36** - \$340 list  
 Bar height chase (28.56"H) model # **OBLOSWM3SCM42** - \$360 list

#### Wire Management Stretcher options:

Losa wire management mouse hole (1) stretcher at the top / center  
 model # **OBLOSWMHHS** - \$20 list

Losa wire management notched cut out for power supply (1) stretcher at top / center

#### Wire Management End Panel options:

Losa wire management mouse hole (1) in the end panel at the top / center  
 model # **OBLOSWMHET** - \$20 list

Losa wire management mouse hole (1) in the end panel at the bottom / center  
 model # **OBLOSWMHEB** - \$20 list

#### Full Height Stretcher Option - 2 piece top :

- (1) full height stretcher centered under each half of the 2 piece top- model # **OBLOS2PCFHS2** - \$500 list
- (2) full height stretchers centered under each half of the 2 piece top - model # **OBLOS2PCFHS4** - \$970 list

#### Full Height Stretcher Option - 3 piece top :

- (1) full height stretcher centered under each piece of the 3 piece top - model # **OBLOS3PCFHS3** - \$940 list
- (2) full height stretchers centered under each piece of the 3 piece top - model # **OBLOS3PCFHS6** - \$1870 list

\*shown with optional wire management 3-sided chase

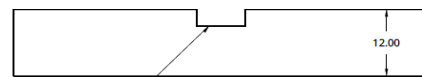
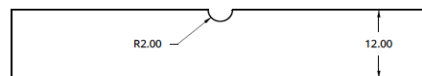
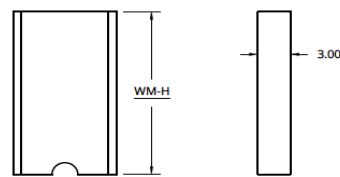
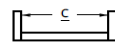
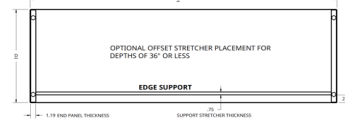

SIZE OF CUTOUT IS ADJUSTABLE TO MATCH POWER SUPPLY CUTOUT IN TABLE TOP

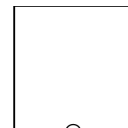
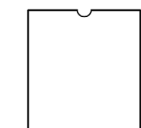

MOUSE HOLE AT THE TOP / CENTER OF A LOSA PANEL BASE

MOUSE HOLE AT THE BOTTOM / CENTER OF A LOSA PANEL BASE

# tables

## Losa 2 & 3 piece counter and bar height

2 or 3 piece top	dimensions	model no.	PVA	PVB	PVC	LTA	LTB	LTC
			3mm PVC Grade A list	3mm PVC Grade B list	3mm PVC Grade C list	1-5/8" laminate self edge Grade A list	1-5/8" laminate self edge Grade B list	1-5/8" laminate self edge Grade C list
2	24 x 120*	TLLOS24120	3,400	3,520	3,890	3,600	3,650	3,980
2	24 x 144*	TLLOS24144	3,770	3,840	4,270	4,020	4,060	4,540
2	24 x 192*	TLLOS24192	4,490	4,540	5,100	4,800	4,860	5,480
3	24 x 216*	TLLOS24216	5,390	5,450	6,080	5,740	5,800	6,510
3	24 x 240*	TLLOS24240	5,750	5,800	6,510	6,140	6,190	6,970
2	30 x 120**	TLLOS30120	3,830	3,970	4,370	4,050	4,110	4,520
2	30 x 144**	TLLOS30144	4,510	4,580	5,040	4,770	4,840	5,350
2	30 x 192**	TLLOS30192	5,290	5,350	5,960	5,630	5,690	6,370
3	30 x 216**	TLLOS30216	5,950	6,000	6,700	6,340	6,390	7,160
3	30 x 240**	TLLOS30240	6,340	6,390	7,160	6,770	6,820	7,680
2	36 x 120**	TLLOS36120	4,210	4,330	4,760	4,440	4,500	4,900
2	36 x 144**	TLLOS36144	4,650	4,770	5,240	4,880	4,930	5,360
2	36 x 192**	TLLOS36192	5,640	5,700	6,340	6,000	6,060	6,770
3	36 x 216**	TLLOS36216	6,330	6,370	7,100	6,710	6,780	7,560
3	36 x 240**	TLLOS36240	6,710	6,780	7,570	7,150	7,220	8,090
2	42 x 120	TLLOS42120	4,710	4,840	5,310	4,940	4,990	5,430
2	42 x 144	TLLOS42144	4,710	5,190	5,710	5,460	5,500	5,980
2	42 x 192	TLLOS42192	6,300	6,370	7,020	6,710	6,770	7,490
3	42 x 216	TLLOS42216	7,030	7,100	7,890	7,470	7,540	8,430
3	42 x 240	TLLOS42240	7,470	7,540	8,430	7,980	8,030	9,020
2	48 x 120	TLLOS48120	4,710	4,840	5,310	4,940	4,990	5,430
2	48 x 144	TLLOS48144	5,050	5,190	5,710	5,460	5,500	5,980
2	48 x 192	TLLOS48192	6,450	6,480	7,220	6,840	6,900	7,690
3	48 x 216	TLLOS48216	7,030	7,100	7,890	7,470	7,540	8,430
3	48 x 240	TLLOS48240	7,470	7,540	8,430	7,980	8,030	9,020
2	54 x 120	TLLOS54120	5,960	6,010	6,590	6,090	6,140	6,770
2	54 x 144	TLLOS54144	6,230	6,290	6,940	6,380	6,440	7,110
2	54 x 192	TLLOS54192	7,290	7,340	8,200	7,480	7,540	8,430
3	54 x 216	TLLOS54216	8,430	8,470	9,490	8,650	8,710	9,780
3	54 x 240	TLLOS54240	8,940	9,010	10,130	9,210	9,260	10,440
2	60 x 120	TLLOS60120	6,240	6,280	6,860	6,370	6,420	7,030
2	60 x 144	TLLOS60144	6,510	6,570	7,220	6,670	6,710	7,390
2	60 x 192	TLLOS60192	7,570	7,620	8,470	7,760	7,820	8,710
3	60 x 216	TLLOS60216	8,700	8,760	9,780	8,930	8,980	10,050
3	60 x 240	TLLOS60240	9,230	9,270	10,410	9,480	9,540	10,710

Please contact [service@symphonytables.com](mailto:service@symphonytables.com) to make sure that your power and/or wire management solution will work with the Losa table specification. We are able to modify this table with a custom solution to fit your projects needs.

**Grain match fees** for 2 piece woodgrain laminate tops are located on page 4 of the price list. For grain match fees on 3-piece tops, please email [service@symphonytables.com](mailto:service@symphonytables.com). This is for the top only, not all components of the Losa table.

# tables

## Sala occasional

For complete model number:

1. insert base code:

**S** = no plinth base



**P** = 3/4" plinth base

2. insert laminate grade code:

**A** = grade A laminate

**B** = grade B laminate

**C** = grade C laminate

shape	dimension	height	model no.	S = no plinth base			P = 3/4" plinth base		
				A	B	C	A	B	C
cylinder 	18	15	TLSAL180015	950	1,000	1,120	1,120	1,180	1,290
	24	15	TLSAL240015	1,070	1,130	1,250	1,240	1,320	1,450
	30	15	TLSAL300015	1,340	1,420	1,630	1,580	1,660	1,830
	36	15	TLSAL360015	1,540	1,630	1,890	1,830	1,930	2,110
	18	20	TLSAL180020	990	1,030	1,170	1,160	1,210	1,330
	24	20	TLSAL240020	1,160	1,210	1,350	1,340	1,400	1,540
	30	20	TLSAL300020	1,400	1,470	1,660	1,610	1,680	1,870
	36	20	TLSAL360020	1,660	1,750	1,960	1,880	1,970	2,180
	18	24	TLSAL180024	1,020	1,070	1,200	1,190	1,230	1,360
	24	24	TLSAL240024	1,210	1,280	1,440	1,400	1,470	1,630
	30	24	TLSAL300024	1,460	1,530	1,730	1,660	1,740	1,930
	36	24	TLSAL360024	1,760	1,840	2,080	1,970	2,080	2,290
oval 	20x36	15	TLSAL203615	2,210	2,320	2,610	2,390	2,510	2,780
	22x40	15	TLSAL224015	2,330	2,440	2,760	2,520	2,650	2,940
	24x46	15	TLSAL244615	2,590	2,720	3,060	2,810	2,950	3,270
	20x36	20	TLSAL203620	2,370	2,490	2,780	2,540	2,670	2,960
	22x40	20	TLSAL224020	2,440	2,560	2,900	2,640	2,770	3,080
	24x46	20	TLSAL244620	2,760	2,900	3,250	2,980	3,120	3,470
	20x36	24	TLSAL203624	2,460	2,570	2,900	2,640	2,770	3,080
	22x40	24	TLSAL224024	2,560	2,700	3,040	2,760	2,900	3,230
	24x46	24	TLSAL244624	2,870	3,010	3,390	3,090	3,250	3,600
square corner cube 	18x18	15	TLSAL181815	1,000	1,050	1,180	1,180	1,230	1,350
	24x24	15	TLSAL242415	1,160	1,210	1,350	1,340	1,420	1,540
	30x30	15	TLSAL303015	1,340	1,420	1,580	1,540	1,620	1,780
	36x36	15	TLSAL363615	1,570	1,650	1,840	1,780	1,880	2,070
	18x18	20	TLSAL181820	1,050	1,090	1,230	1,220	1,290	1,420
	24x24	20	TLSAL242420	1,210	1,280	1,440	1,400	1,470	1,630
	30x30	20	TLSAL303020	1,460	1,530	1,730	1,660	1,740	1,930
	36x36	20	TLSAL363620	1,670	1,760	1,980	1,900	1,990	2,210
	18x18	24	TLSAL181824	1,070	1,130	1,250	1,240	1,310	1,440
	24x24	24	TLSAL242424	1,280	1,330	1,510	1,460	1,530	1,690
	30x30	24	TLSAL303024	1,520	1,600	1,800	1,730	1,800	1,990
	36x36	24	TLSAL363624	1,820	1,910	2,130	2,040	2,130	2,370
square corner rectangle	24x30	15	TLSAL243015	1,340	1,420	1,570	1,550	1,630	1,780
	24x48	15	TLSAL244815	1,520	1,600	1,770	1,760	1,840	2,010
	24x30	20	TLSAL243020	1,510	1,580	1,680	1,660	1,750	1,900
	24x48	20	TLSAL244820	1,780	1,880	1,910	1,880	1,970	2,130
	24x30	24	TLSAL243024	1,640	1,730	1,760	1,730	1,800	1,970
	24x48	24	TLSAL244824	1,950	2,050	1,980	1,950	2,050	2,220

Formica + Wilsonart HPL laminate finish grades listed on pages 20-27. For additional laminate grades, contact Symphony.

Sala bases feature a non-adjustable plastic tack glide.

# surfaces



# surfaces

## surface and egde overview

### Standard particleboard

The standard core consists of 1.125" thick, 45 lb. industrial grade western particleboard. This meets or exceeds requirements of ANSA A 208 1979, 1-M-3 and is TECO tested per ASTM D-1037. The core is laminated with a .040" thick high pressure laminate top, while the underside has a .035" Polybak Ultra backing sheet applied.

### High Pressure Laminate (HPL) surface

Symphony produces tops with virtually any laminate. Most Formica and Wilsonart laminates are grade A, B, or C (see listings). However, some Formica and Wilsonart laminates plus laminates from other suppliers can exceed grade C pricing plus have extended lead times. To verify pricing and lead-times, please email [service@symphonytables.com](mailto:service@symphonytables.com) for assistance.

### To check availability or to order any samples please contact the laminate companies directly.

www.Formica.com 800-FORMICA  
 www.Nevamar.com 800-638-4380  
 www.Wilsonart.com 800-433-3222  
 www.Pionite.com 800-746-6483

### Edges 3mm PVC (PVEA)

Edge is banded with 3-mm extruded synthetic PVC molding. The molding top and bottom edges feature a slight radius, adding comfort. The 90 degree corners create a seamless table to table fit.

### 3mm PVC Knife (PVKN)

Edge is banded with .462 high rigid 3-mm extruded synthetic PVC molding. The top edge molding features a slight radius, adding comfort. The bottom of the edge features exposed MDF core sanded smooth with a wax coating, the slanted edge has a 20 degree angle. The 90 degree corners create a seamless table to table fit.

\* Symphony can paint the PVKN edge instead of having raw particle board for an additional cost and lead time. Email [service@symphonytables.com](mailto:service@symphonytables.com) for more information.

### Vinyl (VNEA)

Edges are banded with solid vinyl convex "T" molding, 1.5" radius corners. The edge is hammered into the side of the top.

Grain match fees for 2-piece tops in a woodgrain laminate are located on page 4 of the price list.

# surfaces

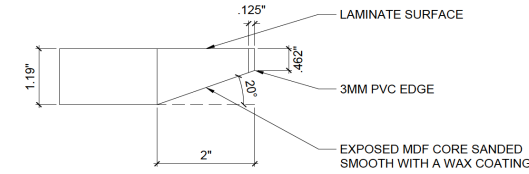

## egde profile overview

	Edge Code	Profile	Corners	Height	Depth	Standard Finishes
PVC	PVEA	eased	90°	1.19"	0.125"	<b>To match Wilsonart laminates:</b> Alabaster, Amber Cherry, Antique White, Asian Night, Asian Sand, Atlantis, Bannister Oak, Beigewood, Biltmore Cherry, Black, Blond Echo, Brazilwood, Brighton Walnut, Cafelle, Cocobala, Coffee Bean, Columbian Walnut, Designer White, Dove Grey, Ebony Recon, Empire Mahogany, Field Elm, Figured Mahogany, Fonthill Pear, Frosty White, Fusion Maple, Graphite Nebula, Grey, Grey Elm, Grey Mesh, Hampton Walnut, Harvest Maple, High Line, Huntington Maple, Kensington Maple, Khaki Brown, Limber Maple, Linen, Manitoba Maple, Montana Walnut, Monticello Maple, Natural Almond, Nepal Teak, North Sea, Pebble, Pepperdust, Pinnacle Walnut, Platinum, River Cherry, Satin Stainless, Shadow, Skyline Walnut, Slate Grey, Solar Oak, Studio Teak, Tan Echo, Wallaby, Walnut Heights, White, Wild Cherry, Williamsburg Cherry, Windsor Mahogany, Zanzibar.
	PVKN	knife	90°	1.19"	2"	
						<b>To match Fomica laminates:</b> Almond, Amber Maple, Antique White, Black, Bleached Legno, Brite White, Dover White, Fog, Folkstone, Graphite, Graystone, Hard Rock Maple, Natural Maple, Neutral Twill, Platinum, Prestige Walnut, Pumice, Select Cherry, Stone Grafix, Storm, White
						*Note that this list is subject to change at any time depending on the availability of the edge from the top plant or the edge manufacturer.
vinyl	VNEA	eased	1.5" radius	1.19"	0.125"	<b>To match Wilsonart laminates:</b> Black, Frosty White, Slate Grey, Fashion Grey <b>To match Formica laminates:</b> Fog
						* Note that this list is subject to change at any time depending on the availability of the edge from our plant or the edge manufacturer.



# surfaces

shapes, dimensions, weight, seating capacity

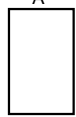
shape	A x B	seats	approximate weight (lbs)
round (RD) 	24 dia.	2	18
	30 dia.	2	28
	36 dia.	3	41
	42 dia.	4	55
	48 dia.	4-5	72
	60 dia.	5	91
	60 dia.	6-7	113
square (SQ) 	24 x 24	2	18
	30 x 30	2	28
	36 x 36	4	42
	42 x 42	4	55
	48 x 48	4	72
	60 x 60	6-8	113
rectangle (RE) 	18 x 48	1	27
	* 18 x 60	2	34
	* 18 x 72	2	41
	* 18 x 84	2-3	48
	* 18 x 90	3	51
	* 18 x 96	3	54
	24 x 30	1	23
	24 x 36	1	27
	24 x 42	1	32
	24 x 48	1	36
	* 24 x 60	2	45
	* 24 x 66	2	50
	* 24 x 72	2	54
	* 24 x 84	2-3	63
	* 24 x 90	3	68
	* 24 x 96	3	72
	30 x 36	2	34
	30 x 42	2	40
	30 x 48	2-4	45
	** 30 x 60	4	57
	** 30 x 66	4-6	62
	** 30 x 72	6	68
	** 30 x 84	2-3	79
	** 30 x 90	3	85
** 30 x 96	3	90	
36 x 42	2	48	
36 x 48	2-4	54	
** 36 x 60	4-6	68	
** 36 x 72	6-8	81	
** 36 x 84	6-8	95	
** 36 x 90	6-8	102	
** 36 x 96	8-10	108	
2+ 36 x 120	8-10	135	
** 42 x 60	6	79	
** 42 x 72	6-8	95	
** 42 x 84	6-8	111	
** 42 x 96	8-10	126	
2+ 42 x 120	8-10	158	
2+ 42 x 144	10	190	
** 48 x 72	6	108	
** 48 x 84	6-8	126	
** 48 x 96	8-10	144	
2+ 48 x 120	8-10	180	
2+ 48 x 144	10	216	
2+ 48 x 168	10	252	
** 60 x 96	8-10	180	
2+ 60 x 120	10-12	225	
2+ 60 x 144	10-12	270	
2+ 60 x 168	12	315	

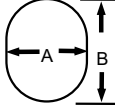
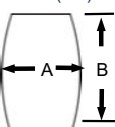
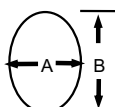
shape	A x B	seats	approximate weight (lbs)	
racetrack (RA) 	** 36 x 72	4	81	
	** 36 x 84	6	95	
	** 36 x 96	6-8	108	
	2+ 36 x 120	8	135	
	** 42 x 72	6	95	
	** 42 x 96	8	126	
	2+ 42 x 120	8	158	
	** 48 x 96	8-10	144	
	2+ 48 x 120	8-10	180	
	2+ 48 x 144	10	216	
	2+ 48 x 168	10	252	
	** 60 x 96	8-10	180	
2+ 60 x 120	10-12	225		
2+ 60 x 144	10-12	270		
2+ 60 x 168	12	315		
boat (BO) 	** 36 x 72	4	81	
	** 36 x 84	6	95	
	2+ 36 x 96	6-8	108	
	** 42 x 96	8	126	
	** 48 x 96	8-10	144	
	2+ 48 x 120	8-10	180	
	** 60 x 96	8-10	180	
	2+ 60 x 120	10-12	225	
	2+ 60 x 144	10-12	270	
	2+ 60 x 168	12	315	
	oval (OV) 	** 36 x 72	4	81
		** 36 x 84	6	95
** 36 x 96		6-8	108	
2+ 36 x 120		8	135	
** 42 x 72		6	95	
** 42 x 96		8	126	
** 48 x 96		8-10	144	
2+ 48 x 120		8-10	180	
2+ 48 x 144		10	216	
2+ 48 x 168		10	252	
** 60 x 96		8-10	180	
2+ 60 x 120		10-12	225	
2+ 60 x 144	10-12	270		
2+ 60 x 168	12	315		

\* 1 support bar included  
 \*\* 2 support bars included  
 2+ 2 piece top with bars + table lock set included

\*\*\* 120" - 144" two piece tops can be produced as one piece upon request with additional packaging and freight charges



Grain match fees for 2-piece tops with a woodgrain laminate are located on page 4 of the price list.



Seating capacity is a guide only. Capacity will vary according to seating width, design and layout. Capacity based on 30" minimum width per seat and use on all potential sides.

For pricing on custom size 3mm edge (PVEA) surfaces just use next largest standard size price. For unusual shapes and other special pricing, email service@symphonytables.com for assistance.

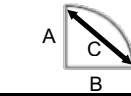
# surfaces

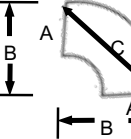
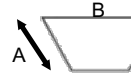
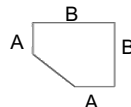
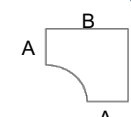
additional shapes, dimensions

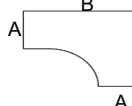
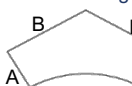
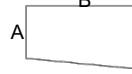
shape	A x B x C
quarter round (QR) 	18 x 18 x 25.5
	24 x 24 x 34
	30 x 30 x 42.5
half round (HA) 	18 x 36
	24 x 48
	30 x 60
crescent (CR) 	18 x 36 x 51
	24 x 48 x 68
	24 x 60 x 94
	30 x 60 x 96
trapezoid (TR) 	24 x 48 x 21
	30 x 60 x 26
	30 x 72 x 31
corner - angled (CA) 	24 x 36
	24 x 42
	24 x 48
corner - curved (CC) 	24 x 36
	24 x 42
	24 x 48

shape	A x B x C
corner - extended (CE) curved front 	24 x 60 x 36
	24 x 72 x 36
	24 x 60 x 48
	24 x 72 x 48
corner - 120 degree (12) 	24 x 36
	24 x 42
	24 x 48
wedge (WE) 	24 x 36 x 30
	24 x 42 x 30
	24 x 48 x 30
	24 x 60 x 30
corner - angled (CA) 	30 x 36 x 24
	30 x 42 x 24
	30 x 48 x 24
	30 x 60 x 24



# surfaces

Wilsonart laminates by number  
+ matching 3mm edges (PVEA + PVKN)

Lam No	Laminate Name	Laminate Finish Grade			3mm edge	Lam No	Laminate Name	Laminate Finish Grade			3mm edge
		A	B	C				A	B	C	
1500	Grey		60		std stock	4846	Morro Zephyr		60		*F
1503	Putty		60		*F	4856	Cloud Zephyr		60		*R
1530	Beige		60		*R	4857	Shadow Zephyr		60		*R
1531	Light Beige		60		*R	4859	Spiced Zephyr		60		*R
1570	White		60		std stock	4860K	Silver Alchemy			7	*R
1572	Antique White	60			std stock	4861K	Gold Alchemy			7	*R
1573	Frosty White	60			std stock	4862	Sandy Topaz			7	*R
1595	Black	60			std stock	4869	Western White		60		*R
1787	Oxide		60		*R	4871	Western Suede		60		*R
2932	Almond Leather		60		*R	4876	Sheer Mesh		38		*R
4142	Grey Glace		60		*R	4877	Grey Mesh		38		std stock
4143	Neutral Glace		60		*R	4878	Pewter Mesh		38		*F
4166	Pampas		60		*R	4879	Steel Mesh		38		*F
4168	Grey Pampas		60		*R	4880	Carbon Mesh		38		*F
4170	Beige Pampas		60		*R	4882	Oiled Soapstone		38		*F
4588	Kalahari Topaz			7	*R	4883	Sable Soapstone		38		
4589K	Smoky Topaz			7	*R	4885	Green Soapstone		38		*R
4621	White Nebula		60		*F	4886	Pearl Soapstone		38		*R
4622	Grey Nebula		60		*F	4887	Tan Soapstone		38		*F
4623	Graphite Nebula		60		std stock	4888	Rustic Sate		38		*R
4630	Cloud Nebula		60		*R	4909	Ginseng Tea		60		
4651	Navy Legacy		60		*R	4911	Soft Gold Mesh		38		*R
4656	Bronze Legacy		60		*R	4912	Gilded Mesh		38		
4663	Tawny Legacy		60		*R	4915	Tangerine		60		*R
4667	Green Tigris		60		*R	4918	Sprout		60		*R
4669	Natural Tigris		60		*R	4939K	Vapor Strandz			18	*R
4674	Evening Tigris		60		*F	4940K	Astro Strandz			18	*R
4745	Maroochy Brush		60			4941K	Cosmic Strandz			18	*F
4746	Woolamai Brush		60			4996	High Rise		38		*R
4779	Pewter Brush		60		*F	7039K	Windsor Mahogany			78	std stock
4783	White Tigris		60		*R	7040K	Figured Mahogany			78	std stock
4794	Windswept Bronze		60		*R	7054	Wild Cherry	60			std stock
4795	Windswept Pewter		60		*R	7061	Natural Pear		60		*F
4796	Burnished Chestnut		60		*R	7110K	Montana Walnut			78	std stock
4810	Titanium EV		60		*R	7122K	Empire Mahogany			7	std stock
4811	Silicon EV		60		*R	7209K	Nepal Teak			78	std stock
4813	Nickel EV		60		*R	7806	Bannister Oak		60		std stock
4814	Tungsten EV		60		*R	7816	Solar Oak		60		std stock
4820	Carbon EV		60		*F	7850	Beigewood		60		std stock
4823	Antique Brush		60		*F	7909	Fusion Maple	60			std stock
4830K	Satin Stainless			18	std stock	7911	Manitoba Maple		60		std stock
4841	Desert Zephyr		60		*F	7919K	Amber Cherry			78	std stock
4842	Canyon Zephyr		60		*R	7921	Tuscan Walnut		38		*F
4843	Misted Zephyr		60		*R	7922	Brighton Walnut			7	std stock
4844	Loden Zephyr		60		*R	7923K	Versailles Anigre			7	*F
4845	Twilight Zephyr		60		*R	7924K	Biltmore Cherry			7	std stock

std stock - flex 3mm PVC edge stocked & available for any size/shape top at standard lead time  
 \*F - Flexible PVEA 3mm PVC edge available for an upcharge and a possible extended lead time depending on top sizes and quantity  
 \*R - Rigid PVEA 3mm PVC edge available for an upcharge and a possible extended lead time depending on top sizes and quantity - note that the rigid form prevents the use of this edge on curved or round tops  
 Please note that edge banding availability is subject to change.

# surfaces

Wilsonart laminates by number  
+ matching 3mm edges (PVEA + PVKN)

Lam No	Laminate Name	Laminate Finish Grade			3mm edge	Lam No	Laminate Name	Laminate Finish Grade			3mm edge
		A	B	C				A	B	C	
7925	Monticello Maple	38			std stock	7987	Palisades Oak		38		*R
7928	Castle Oak		38		*F	7988	Hibiscus Cherry		38		
7929	Huntington Maple		38		std stock	7989	Persian Cherry		38		
7933K	Cafelle			7	std stock	7990	Mission Maple		38		*R
7935K	Shaker Cherry			7		7991	Neowalnut		38		*R
7936K	Williamsburg Cherry			7	std stock	7992	Pinnacle Walnut		38		std stock
7937	River Cherry	38			std stock	7993	Florence Walnut		38		*R
7938	New Age Oak		38		*R	7994	Lowell Ash		38		*R
7939K	Blond Echo			18	std stock	7995	Sterling Ash		38		*R
7941K	Tan Echo			18	std stock	7996	Natural Recon		38		*R
7942K	Cocobala			7	std stock	7997	Ebony Recon		38		std stock
7943K	Colombian Walnut			7	std stock	7998K	Low Line			18	
7944K	Madagascar			1		7999K	Field Elm			12	std stock
7945K	Xanadu			18	*R	8200K	White Driftwood			16	
7946	Brazilwood		38		std stock	8201K	Grey Elm			12	std stock
7947K	Rio			18	*R	8204K	Weathered Char			16	*R
7948K	Mambo			7	*F	8205K	Ebony Char			16	
7949K	Asian Night			18	std stock	8206K	Saddle Oak			16	
7951K	Asian Sun			18	*R	8207K	Branded Oak			16	*R
7952K	Asian Sand			18	std stock	8208K	Fawn Cypress			16	*R
7953	Harvest Maple		38		std stock	10734	Limber Maple		60		std stock
7954	Natural Rift		38		*R	10745	Fonthill Pear		60		std stock
7957K	Zanzibar			78	std stock	10776	Kensington Maple	60			std stock
7959K	Hampton Walnut			78	std stock	D12	Regimental Red			18	*R
7960K	Studio Teak			18	std stock	D14	Port			60	*F
7962K	Aloe			18	*R	D25	Atlantis			60	std stock
7964K	Skyline Walnut			12	std stock	D30	Natural Almond			60	std stock
7965K	Walnut Heights			12	std stock	D307	Hollyberry			60	*F
7966K	5th Ave. Elm			12	*R	D315	Platinum			60	std stock
7967K	Park Elm			12	*R	D321	Brittany Blue			60	*F
7968K	Loft Oak			12	*R	D327	Pepperdust			60	std stock
7969K	Warehouse Oak			12		D337	Pebble			60	std stock
7970K	High Line			18	std stock	D354	Designer White	60			std stock
7971K	Uptown Walnut			12	*R	D379	Indigo			60	*R
7972K	Truss Maple			12		D381	Fashion Grey		60		*F
7973K	Old Mill Oak			12	*R	D403	White Sand			60	*R
7975K	Raw Chestnut			12		D417	Lapis Blue			60	*R
7976K	White Cypress			12	*R	D427	Linen			60	std stock
7977K	White Barn			12	*R	D431	Alabaster			60	std stock
7980K	Zebra wood			18	*F	D439	Wallaby			60	std stock
7981K	Landmark Wood			12	*R	D495	Coffee Bean			60	std stock
7982	Buka Bark		38		*R	D50	Khaki Brown			60	std stock
7983	Boardwalk Oak		38		*R	D90	North Sea			60	std stock
7984	Mangalore Mango		38		*R	D91	Slate Grey		60		std stock
7985	Morelia Mango		38		*R	D92	Dove Grey		60		std stock
7986	Pasadena Oak		38		*R	D96	Shadow		60		std stock

Please note: additional laminates and finishes may be available with additional fees and/or extended lead times  
 Contact Symphony for pricing and lead time information: [service@symphonytables.com](mailto:service@symphonytables.com)  
 Laminates and specific finishes may be discontinued by Formica or Wilsonart. For the most up to date information, contact your Formica or Wilsonart representative.

# surfaces

Wilsonart laminates by name  
+ matching 3mm edges (PVEA + PVKN)

Laminate Name	Lam No	Laminate Finish Grade			3mm edge	Laminate Name	Lam No	Laminate Finish Grade			3mm edge
		A	B	C				A	B	C	
5th Ave. Elm	7966K			12	*R	Fawn Cypress	8208K			16	*R
Alabaster	D431		60		std stock	Field Elm	7999K			12	std stock
Almond Leather	2932		60		*R	Figured Mahogany	7040K			78	std stock
Aloe	7962K			18	*R	Florence Walnut	7993		38		*R
<b>Amber Cherry</b>	<b>7919K</b>			78	std stock	Fonthill Pear	10745		60		std stock
Antique Brush	4823		60		*F	<b>Frosty White</b>	<b>1573</b>		<b>60</b>		std stock
Antique White	1572	60			std stock	<b>Fusion Maple</b>	<b>7909</b>		<b>60</b>		std stock
<b>Asian Night</b>	<b>7949K</b>			18	std stock	Gilded Mesh	4912		38		
Asian Sand	7952K			18	std stock	Ginseng Tea	4909		60		
Asian Sun	7951K			18	*R	Gold Alchemy	4861K		7		*R
Astro Strandz	4940K			18	*R	Graphite Nebula	4623		60		std stock
Atlantis	D25		60		std stock	Green Soapstone	4885		38		*R
Bannister Oak	7806		60		std stock	Green Tigris	4667		60		*R
Beige	1530		60		*R	Grey	1500		60		std stock
Beige Pampas	4170		60		*R	Grey Elm	8201K		12		std stock
Beigewood	7850		60		std stock	Grey Glace	4142		60		*R
Biltmore Cherry	7924K			7	std stock	Grey Mesh	4877		38		std stock
<b>Black</b>	<b>1595</b>	<b>60</b>			std stock	Grey Nebula	4622		60		*F
Blond Echo	7939K			18	std stock	Grey Pampas	4168		60		*R
Boardwalk Oak	7983		38		*R	Hampton Walnut	7959K		78		std stock
Branded Oak	8207K			16	*R	Harvest Maple	7953		38		std stock
Brazilwood	7946		38		std stock	Hibiscus Cherry	7988		38		
Brighton Walnut	7922			7	std stock	High Line	7970K		18		std stock
Brittany Blue	D321		60		*F	High Rise	4996		38		*R
Bronze Legacy	4656		60		*R	Hollyberry	D307		60		*F
Buka Bark	7982		38		*R	Huntington Maple	7929		38		std stock
Burnished Chestnut	4796		60		*R	Indigo	D379		60		*R
<b>Cafelle</b>	<b>7933K</b>			7	std stock	Kalahari Topaz	4588		7		*R
Canyon Zephyr	4842		60		*R	<b>Kensington Maple</b>	<b>10776</b>		<b>60</b>		std stock
Carbon EV	4820		60		*F	<b>Khaki Brown</b>	<b>D50</b>		<b>60</b>		std stock
Carbon Mesh	4880		38		*F	Landmark Wood	7981K		12		*R
Castle Oak	7928		38		*F	Lapis Blue	D417		60		*R
Cloud Nebula	4630		60		*R	Light Beige	1531		60		*R
Cloud Zephyr	4856		60		*R	Limber Maple	10734		60		std stock
Cocobala	7942K			7	std stock	Linen	D427		60		std stock
<b>Coffee Bean</b>	<b>D495</b>		<b>60</b>		std stock	Loden Zephyr	4844		60		*R
<b>Colombian Walnut</b>	<b>7943K</b>			7	std stock	Loft Oak	7968K		12		*R
Cosmic Strandz	4941K			18	*F	Low Line	7998K		18		
Desert Zephyr	4841		60		*F	Lowell Ash	7994		38		*R
<b>Designer White</b>	<b>D354</b>	<b>60</b>			std stock	Madagascar	7944K		1		*F
Dove Grey	D92		60		std stock	Mambo	7948K		7		*R
Ebony Char	8205K			16		Mangalore Mango	7984		38		*R
Ebony Recon	7997		38		std stock	Manitoba Maple	7911		60		std stock
Empire Mahogany	7122K			7	std stock	Maroochy Brush	4745		60		
Evening Tigris	4674		60		*F	Mission Maple	7990		38		*R
Fashion Grey	D381		60		*F	Misted Zephyr	4843		60		*R

std stock - flex 3mm PVC edge stocked & available for any size/shape top at standard lead time  
 \*F - Flexible PVEA 3mm PVC edge available for an upcharge and a possible extended lead time depending on top sizes and quantity  
 \*R - Rigid PVEA 3mm PVC edge available for an upcharge and a possible extended lead time depending on top sizes and quantity - note that the rigid form prevents the use of this edge on curved or round tops  
 Please note that edge banding availability is subject to change.  
 Email [service@symphonytables.com](mailto:service@symphonytables.com) to check pricing and lead time prior to ordering for \*F and \*R edge banding.

# surfaces

Wilsonart laminates by name  
+ matching 3mm edges (PVEA + PVKN)

Laminate Name	Lam No	Laminate Finish Grade			3mm edge	Laminate Name	Lam No	Laminate Finish Grade			3mm edge
		A	B	C				A	B	C	
Montana Walnut	7110K			78	std stock	Silicon EV	4811		60		*R
<b>Monticello Maple</b>	<b>7925</b>	<b>38</b>			std stock	Silver Alchemy	4860K			7	*R
Morelia Mango	7985		38		*R	<b>Skyline Walnut</b>	<b>7964K</b>			12	std stock
Morro Zephyr	4846		60		*F	<b>Slate Grey</b>	<b>D91</b>		<b>60</b>		std stock
Natural Almond	D30		60		std stock	Smoky Topaz	4589K			7	*R
Natural Pear	7061		60		*F	Soft Gold Mesh	4911		38		*R
Natural Recon	7996		38		*R	Solar Oak	7816		60		std stock
Natural Rift	7954		38		*R	Spiced Zephyr	4859		60		*R
Natural Tigris	4669		60		*R	Sprout	4918		60		*R
Navy Legacy	4651		60		*R	Steel Mesh	4879		38		*F
Neowalnut	7991		38		*R	Sterling Ash	7995		38		*R
Nepal Teak	7209K			78	std stock	<b>Studio Teak</b>	<b>7960K</b>			18	std stock
Neutral Glace	4143		60		*R	Tan Echo	7941K			18	std stock
New Age Oak	7938		38		*R	Tan Soapstone	4887		38		*F
Nickel EV	4813		60		*R	Tangerine	4915		60		*R
North Sea	D90		60		std stock	Tawny Legacy	4663		60		*R
Oiled Soapstone	4882		38		*F	Titanium EV	4810		60		*R
Old Mill Oak	7973K			12	*R	Truss Maple	7972K			12	
Oxide	1787		60		*R	Tungsten EV	4814		60		*R
Palisades Oak	7987		38		*R	Tuscan Walnut	7921		38		*F
Pampas	4166		60		*R	Twilight Zephyr	4845		60		*R
Park Elm	7967K			12	*R	Uptown Walnut	7971K			12	*R
Pasadena Oak	7986		38		*R	Vapor Strandz	4939K			18	*R
Pearl Soapstone	4886		38		*R	Versailles Anigre	7923K			7	*F
Pebble	D337		60		std stock	Wallaby	D439		60		std stock
Pepperdust	D327		60		std stock	<b>Walnut Heights</b>	<b>7965K</b>			12	std stock
Persian Cherry	7989		38			Warehouse Oak	7969K			12	
Pewter Brush	4779		60		*F	Weathered Char	8204K			16	*R
Pewter Mesh	4878		38		*F	Western Suede	4871		60		*R
Pinnacle Walnut	7992		38		std stock	Western White	4869		60		*R
Platinum	D315		60		std stock	White	1570		60		std stock
Port	D14		60		*F	White Barn	7977K			12	*R
Putty	1503		60		*F	White Cypress	7976K			12	*R
Raw Chestnut	7975K			12		White Driftwood	8200K			16	
Regimental Red	D12			18	*R	White Nebula	4621		60		*F
Rio	7947K			18	*R	White Sand	D403		60		*R
<b>River Cherry</b>	<b>7937</b>	<b>38</b>			std stock	White Tigris	4783		60		*R
Rustic Sate	4888		38		*R	<b>Wild Cherry</b>	<b>7054</b>		<b>60</b>		std stock
Sable Soapstone	4883		38			Williamsburg Cherry	7936K			7	std stock
Saddle Oak	8206K			16		<b>Windsor Mahogany</b>	<b>7039K</b>			78	std stock
Sandy Topaz	4862		7		*R	Windswept Bronze	4794		60		*R
Satin Stainless	4830K		18		std stock	Windswept Pewter	4795		60		*R
<b>Shadow</b>	<b>D96</b>	<b>60</b>			std stock	Woolamai Brush	4746		60		
Shadow Zephyr	4857		60		*R	Xanadu	7945K			18	*R
Shaker Cherry	7935K			7		Zanzibar	7957K			78	std stock
Sheer Mesh	4876		38		*R	ZebraWood	7980K			18	*F

Please note: additional laminates and finishes may be available with additional fees and/or extended lead times  
 Contact Symphony for pricing and lead time information: [service@symphonytables.com](mailto:service@symphonytables.com)  
 Laminates and specific finishes may be discontinued by Formica or Wilsonart. For the most up to date information, contact your Formica or Wilsonart representative.

# surfaces

Formica laminates by number  
+ matching 3mm edges (PVEA + PVKN)

Lam No	Laminate Name	Laminate Finish Grade			3mm edge
		A	B	C	
118	Finnish Oak	58			*F
204	Butcherblock Maple	58			
299	Ebony Oxide	58			*R
300	Sail White Oxide	58			
303	Antique White Oxide	58			*R
346	Natural Oak	58			*F
459	Brite White	58			std stock
463	Sail White	58			*F
464	Graystone	58			std stock
503	Stone Grafix	58			std stock
507	Folkstone Grafix	58			
515	Graphite Grafix	58			*F
692	Folkstone Celesta	58			*R
756	Natural Maple	58			std stock
758	Blossom Cherrywood	58			
827	White Onyx	90			
837	Graphite	58			std stock
839	Stop Red	58			*F
845	Spectrum Red	58			*F
851	Spectrum Blue	58			*F
858	Pumice	58			std stock
863	Myriad Ribbonwood	58			*F
873	Ebony Ribbonwood	58			*F
899	Desert Beige	58			*F
902	Platinum	58			std stock
909	Black	58			std stock
912	Storm	58			std stock
914	Marine Blue	58			*R
918	Neutral White	58			*F
920	Almond	58			std stock
923	Surf	58			*F
927	Folkstone	58			std stock
928	Mouse	58			*F
929	Oyster Gray	58			*R
932	Antique White	58			std stock
933	Mission White	58			*F
934	Pearl	58			*R
949	White	58			std stock
961	Fog	58			std stock
967	Hunter Green	58			
969	Navy Blue	58			*R
1097	Citadel	58			*R
1150	Vosges Pear	43			*F
1485	Chrome Yellow	58			
1517	Eggplant	58			
1519	Blackened Bronze	58			
1520	Infinity	58			*R
1994	Fox	58			*R
2200	Dark Chocolate	58			*R
2297	Terril	58			*R
2770	Sarum Grey	58			*R
2962	Clementine	58			
3202	Otter	58			*R
3209	Sol	58			*R
3453	Parquet Latte	58			
3485	Black Walnut	58			*F
3505	Storm Solidz	58			*R
3517	Sand Crystall	58			
3526	Travertine	58			
3687	Autumn Indian Slate	58			*R
3690	Basalt Slate	58			*R
3692	Labrador Granite	58			
3696	Shoji Screen	58			
3698	Beluga Beige	58			*R
5281	Dogbone White	58			
5323	Nocturne	58			
5342	Earth	58			*R
5349	Fossil	58			*R
5487	Oiled Walnut	58			*R
5488	Smoky Brown Pear	58			*F
5489	Espresso Pear	58			*F
5875	Neutral Weft	58			*R
5880	Earthen Warp	58			*R
5881	Chocolate Warp	58			*R
5882	Citadel Warp	58			*R
5883	Pecan Woodline	58			*F
5884	Chestnut Woodline	58			*R
5886	Sorrel Cherry	43, 58			*F
5887	Millennium Oak	58			*R
5904	Wild Cherry	43, 58			*F
6206	Planked Deluxe Pear	43, 58			*R
6208	Glamour Cherry	43, 58			*F
6209	Prestige Walnut	43			std stock
6212	Wheat Strand	58			*F
6226	Ivory Kashmir	58			
6306	Wenge Strand	58			*R
6307	Burnt Strand	58			*R
6314	Neo Cloud	58			
6366	Paloma Dark Gray	58			*R
6402	Thermo Walnut	43			*F
6417	Elemental Oxide	58			
6437	Chalked Knotty Ash	58			
6440	Smoked Knotty Ash	58			*F
6447	Sarum Duotex	58			*R
6448	Infinity Duotex	58			*R
6449	Charcoal Duotex	58			

std stock - flex 3mm PVC edge stocked & available for any size/shape top at standard lead time  
 \*F - Flexible PVEA 3mm PVC edge available for an upcharge and a possible extended lead time depending on top sizes and quantity  
 \*R - Rigid PVEA 3mm PVC edge available for an upcharge and a possible extended lead time depending on top sizes and quantity -  
 note that the rigid form prevents the use of this edge on curved or round tops  
 Please note that edge banding availability is subject to change.

# surfaces

Formica laminates by number  
+ matching 3mm edges (PVEA + PVKN)

Lam No	Laminate Name	Laminate Finish Grade			3mm edge
		A	B	C	
6473	Folkstone Hex	58			
6474	Storm Hex	58			
6475	Elemental Blue Steel	58			
6698	Paloma Polar	58			*R
6729	Paloma Bisque	58			*R
6901	Vibrant Green	58			*R
6902	Grenadine	58			
6903	Cassis	58			*R
6907	Amarena	58			
6920	Mineral Spa	58			*R
6925	Maple Woodline	58			*R
6926	Smoky Walnut Woodline	58			*R
6932	Macchiato Walnut	58			*F
6942	Charcoal Boomerang	58			
7008	Acajou Mahogany	43	58		*R
7012	Amber Maple	58			std stock
7014	Colorado Slate	58			*R
7018	Navy Grafix	58			*R
7022	Natural Canvas	58			
7197	Dover White	58			std stock
7213	Earth Wash	58			*R
7264	Lime Stone	58			
7265	Sand Stone	58			
7267	Concrete Stone	58			
7288	Ginger Root Maple	58			*F
7481	Natural Birch	58			*R
7484	Cherry Birch	58			*R
7494	Carrara Envision	58			*R
7708	Flax Gauze	58			*R
7734	Jamocho Granite	58			
7735	Portico Marble	58			*R
7738	Cognac Maple	58			*F
7739	Cocoa Maple	58			*F
7747	Pencil Wood	58			*R
7759	Select Cherry	43			std stock
7812	MDF Solidz	58			*R
7813	Cardboard Solidz	58			*R
7897	Spectrum Green	58			
7966	New Burgundy	58			
8751	Mojave	58			
8792	Winter Sky	58			*R
8793	Green Slate	58			
8794	Enamel	58			
8795	Matrix Blue	58			
8814	Denim Twill	58			
8820	Leaf Green	58			*R
8821	Just Blue	58			*R
8824	White Drops	58			*R
8826	Neutral Twill	58			std stock
8827	Sarum Twill	58	58		*F
8828	Earthen Twill	58			*F
8829	Graphite Twill	58			*F
8830	Elemental Concrete	58			
8831	Elemental Stone	58			*R
8839	Ashen Ribbonwood	58			*F
8841	White Ash				WR *F
8842	Weathered Ash				WR *F
8843	Natural Ash				WR
8844	Aged Ash				WR *F
8845	Bleached Legno	58			std stock
8846	Oiled Legno		58		*F
8848	Blackened Legno		58		*F
8849	Natural Teak		58		*F
8858	Just Rose		58		
8905	Waxed Maple		58		
8906	Danish Maple		58		*R
8917	Rolled Steel		58		
8918	Blackened Steel		58		
8919	Bronzed Steel		58		
8956	Bubble Science		58		
8957	Bubble Organic		58		
8958	Bubble Art		58		
9012	Ebony		58		*R
9256	Auburn Maple		58		
9257	Glow Maple		58		
9283	Walnut Riftwood			NG	*F
9285	White Twill		58		*F
9311	Silver Oak Herringbone		58		
9312	Planked Urban Oak		58		*F
9476	White Ice Granite		43		
9480	Salvage Planked Elm		58		
86992	Hard Rock Maple		58		std stock

Please note: additional laminates and finishes may be available with additional fees and/or extended lead times  
 Contact Symphony for pricing and lead time information: [service@symphonytables.com](mailto:service@symphonytables.com)  
 Laminates and specific finishes may be discontinued by Formica or Wilsonart. For the most up to date information, contact your  
 Formica or Wilsonart representative.



# surfaces

Formica laminates by name

+ matching 3mm edges (PVEA + PVKN)

Laminate Name	Lam No	Laminate Finish Grade			3mm edge	Laminate Name	Lam No	Laminate Finish Grade			3mm edge
		A	B	C							
Acajou Mahogany	7008	43	58		*R	Dover White	7197		58		std stock
Aged Ash	8844			WR	*F	Earth	5342		58		*R
Almond	920		58			Earth Wash	7213		58		*R
Amarena	6907		58			Earthen Twill	8828		58		*F
Amber Maple	7012		58			Earthen Warp	5880		58		*R
Antique White	932		58			Ebony	9012		58		*R
Antique White Oxide	303		58		*R	Ebony Oxide	299		58		*R
Ashen Ribbonwood	8839		58		*F	Ebony Ribbonwood	873		58		*F
Auburn Maple	9256		58			Eggplant	1517		58		
Autumn Indian Slate	3687		58		*R	Elemental Blue Steel	6475		58		
Basalt Slate	3690		58		*R	Elemental Concrete	8830		58		
Beluga Beige	3698		58		*R	Elemental Concrete	8830		58		
Black	909		58			Elemental Oxide	6417		58		
Black Walnut	3485		58			Elemental Oxide	6417		58		
Blackened Bronze	1519		58			Elemental Stone	8831		58		*R
Blackened Legno	8848		58		*F	Enamel	8794		58		
Blackened Steel	8918		58			Espresso Pear	5489		58		*F
<b>Bleached Legno</b>	<b>8845</b>	<b>58</b>				Finnish Oak	118		58		*F
Blossom Cherrywood	758		58			Flax Gauze	7708		58		*R
Brite White	459		58			Fog	961		58		std stock
Bronzed Steel	8919		58			<b>Folkstone</b>	<b>927</b>	<b>58</b>			std stock
Bubble Art	8958		58			Folkstone Celesta	692		58		*R
Bubble Organic	8957		58			Folkstone Grafix	507		58		
Bubble Science	8956		58			Folkstone Hex	6473		58		
Burnt Strand	6307		58		*R	Fossil	5349		58		*R
Butcherblock Maple	204		58			Fox	1994		58		*R
Cardboard Solidz	7813		58		*R	Ginger Root Maple	7288		58		*F
Carrara Envision	7494		58		*R	Glamour Cherry	6208		43, 58		*F
Cassis	6903		58		*R	Glow Maple	9257		58		
Chalked Knotty Ash	6437		58			Graphite	837		58		std stock
Charcoal Boomerang	6942		58			Graphite Grafix	515		58		*F
Charcoal Duotex	6449		58			Graphite Twill	8829		58		std stock
Cherry Birch	7484		58		*R	Graystone	464		58		
Chestnut Woodline	5884		58		*R	Green Slate	8793		58		
Chocolate Warp	5881		58		*R	Grenadine	6902		58		
Chrome Yellow	1485		58			Hard Rock Maple	86992		58		std stock
Citadel	1097		58		*R	Hunter Green	967		58		
Citadel Warp	5882		58		*R	Infinity	1520		58		*R
Clementine	2962		58			Infinity Duotex	6448		58		*R
Cocoa Maple	7739		58		*F	Ivory Kashmire	6226		58		
Cognac Maple	7738		58		*F	Jamocha Granite	7734		58		
Colorado Slate	7014		58		*R	Just Blue	8821		58		*R
Concrete Stone	7267		58			Just Rose	8858		58		
Danish Maple	8906		58		*R	Labrador Granite	3692		58		
Dark Chocolate	2200		58		*R	Leaf Green	8820		58		*R
Denim Twill	8814		58			Lime Stone	7264		58		
Desert Beige	899		58		*F	Macchiato Walnut	6932		58		*F
Dogbone White	5281		58			Maple Woodline	6925		58		*R
						Marine Blue	914		58		*R
						Matrix Blue	8795		58		

std stock - flex 3mm PVC edge stocked & available for any size/shape top at standard lead time  
 \*F - Flexible PVEA 3mm PVC edge available for an upcharge and a possible extended lead time depending on top sizes and quantity  
 \*R - Rigid PVEA 3mm PVC edge available for an upcharge and a possible extended lead time depending on top sizes and quantity - note that the rigid form prevents the use of this edge on curved or round tops

Please note that edge banding availability is subject to change.  
 Email [service@symphonytables.com](mailto:service@symphonytables.com) to check pricing and lead time prior to ordering for \*F and \*R edge banding.

# surfaces

Formica laminates by name

+ matching 3mm edges (PVEA + PVKN)

Laminate Name	Lam No	Laminate Finish Grade			3mm edge	Laminate Name	Lam No	Laminate Finish Grade			3mm edge
		A	B	C							
MDF Solidz	7812		58		*R	Shoji Screen	3696		58		
Millennium Oak	5887		58		*R	Silver Oak Herringbone	9311		58		
Mineral Spa	6920		58		*R	Smoked Knotty Ash	6440		58		*F
Mission White	933		58		*F	Smoky Brown Pear	5488		58		*F
Mojave	8751		58			Smoky Walnut Woodline	6926		58		*R
Mouse	928		58		*F	Sol	3209		58		*R
Myriad Ribbonwood	863		58		*F	Sorrel Cherry	5886		43, 58		*F
Natural Ash	8843			WR		Spectrum Blue	851		58		*F
Natural Birch	7481		58		*R	Spectrum Green	7897		58		
Natural Canvas	7022		58			Spectrum Red	845		58		*F
Natural Maple	756		58			Stone Grafix	503		58		std stock
Natural Oak	346		58		*F	Stop Red	839		58		*F
Natural Teak	8849		58		*F	Storm	912		58		std stock
Navy Blue	969		58		*R	Storm Hex	6474		58		
Navy Grafix	7018		58		*R	Storm Solidz	3505		58		*R
Neo Cloud	6314		58			Surf	923		58		*F
<b>Neutral Twill</b>	<b>8826</b>	<b>58</b>				Terril	2297		58		*R
Neutral Weft	5875		58		*R	Thermo Walnut	6402		43		*F
Neutral White	918		58		*F	Travertine	3526		58		
New Burgundy	7966		58			Vibrant Green	6901		58		*R
Nocturne	5323		58			Vosges Pear	1150		43		*F
Oiled Legno	8846		58		*F	Walnut Riftwood	9283			NG	*F
Oiled Walnut	5487		58		*R	Waxed Maple	8905		58		
Otter	3202		58		*R	Weathered Ash	8842			WR	*F
Oyster Gray	929		58		*R	Wenge Strand	6306		58		*R
Paloma Bisque	6729		58		*R	Wheat Strand	6212		58		*F
Paloma Dark Gray	6366		58		*R	White	949		58		std stock
Paloma Polar	6698		58		*R	White Ash	8841			WR	*F
Parquet Latte	3453		58			White Drops	8824		58		*R
Pearl	934		58		*R	White Ice Granite	9476		43		
Pecan Woodline	5883		58		*F	White Onyx	827		90		
Pencil Wood	7747		58		*R	White Twill	9285		58		*F
Planked Deluxe Pear	6206		43, 58		*R	Wild Cherry	5904		43, 58		*F
Planked Urban Oak	9312		58		*F	Winter Sky	8792		58		*R
Platinum	902		58								
Portico Marble	7735		58								
Prestige Walnut	6209		43								
Pumice	858		58								
Rolled Steel	8917		58								
Sail White	463		58		*F						
Sail White Oxide	300		58								
Salvage Planked Elm	9480		58								
Sand Crystall	3517		58								
Sand Stone	7265		58								
Sarum Duotex	6447		58		*R						
Sarum Grey	2770		58		*R						
Sarum Twill	8827		58		*F						
Select Cherry	7759		43								

Please note: additional laminates and finishes may be available with additional fees and/or extended lead times  
 Contact Symphony for pricing and lead time information: [service@symphonytables.com](mailto:service@symphonytables.com)  
 Laminates and specific finishes may be discontinued by Formica or Wilsonart. For the most up to date information, contact your Formica or Wilsonart representative.

# surfaces

PVEA 3mm eased edge and PVKN knife edge  
round, square, squircle and rectangle

For complete model number insert 2 character edge code:  
(PVEA for eased or PVKN for knife edge)



shape	dimension	model no.	PVEA eased			PVKN knife			
			A	B	C	A	B	C	
 round	18	SLRD18000PV __	200	210	250	230	240	280	
	24	SLRD24000PV __	200	240	280	250	290	320	
	30	SLRD30000PV __	290	310	350	350	390	430	
	36	SLRD36000PV __	340	410	460	440	500	560	
	42	SLRD42000PV __	580	650	760	720	780	890	
	48	SLRD48000PV __	590	680	790	760	850	960	
	54	SLRD54000PV __	920	1,020	1,190	1,140	1,230	1,400	
	60	SLRD60000PV __	980	1,080	1,240	1,240	1,350	1,520	
 square	18 x 18	SLSQ18018PV __	200	210	250	230	240	280	
	24 x 24	SLSQ24024PV __	200	240	280	250	290	320	
	30 x 30	SLSQ30030PV __	290	310	350	350	390	430	
	36 x 36	SLSQ36036PV __	340	410	460	440	500	560	
	42 x 42	SLSQ42042PV __	580	650	760	720	780	890	
	48 x 48	SLSQ48048PV __	590	680	790	760	850	960	
	54 x 54	SLSQ54054PV __	920	1,020	1,190	1,140	1,230	1,400	
60 x 60	SLSQ60060PV __	980	1,080	1,240	1,240	1,350	1,520		
 squircle	30 x 30	SLSC30030PV __	290	310	350	350	390	430	
	36 x 36	SLSC36036PV __	390	420	480	470	510	580	
	42 x 42	SLSC42042PV __	630	650	760	760	780	890	
	48 x 48	SLSC48048PV __	650	680	790	830	850	960	
	54 x 54	SLSC54054PV __	990	1,020	1,190	1,200	1,230	1,400	
	60 x 60	SLSC60060PV __	1,020	1,080	1,240	1,300	1,350	1,520	
 rectangle	18 x 36	SLRE18036PV __	260	300	340	310	340	400	
	18 x 42	SLRE18042PV __	300	330	400	350	400	450	
	18 x 48	SLRE18048PV __	300	330	400	350	400	450	
	* 18 x 54	SLRE18054PV __	430	480	560	500	560	630	
	* 18 x 60	SLRE18060PV __	430	460	540	510	550	620	
	* 18 x 66	SLRE18066PV __	480	510	580	570	590	660	
	* 18 x 72	SLRE18072PV __	500	530	590	590	620	690	
	* 18 x 84	SLRE18084PV __	660	700	790	770	800	900	
	* 18 x 90	SLRE18090PV __	700	740	850	830	860	960	
	* 18 x 96	SLRE18096PV __	730	760	870	860	890	1,000	
		24 x 30	SLRE24030PV __	260	280	320	320	330	390
		24 x 36	SLRE24036PV __	290	300	350	340	350	420
		24 x 42	SLRE24042PV __	320	330	390	400	410	450
		24 x 48	SLRE24048PV __	340	350	420	430	440	500
	* 24 x 54	SLRE24054PV __	450	500	570	550	590	660	
	* 24 x 60	SLRE24060PV __	470	500	570	580	610	680	
	* 24 x 66	SLRE24066PV __	500	530	610	620	640	730	
	* 24 x 72	SLRE24072PV __	530	550	620	650	680	750	
	* 24 x 84	SLRE24084PV __	700	740	840	860	890	990	
	* 24 x 90	SLRE24090PV __	740	770	880	900	940	1,050	
	* 24 x 96	SLRE24096PV __	750	780	890	910	950	1,060	
		30 x 36	SLRE30036PV __	350	390	440	440	460	530
		30 x 42	SLRE30042PV __	390	410	470	470	500	570
		30 x 48	SLRE30048PV __	410	430	500	510	540	610
	** 30 x 54	SLRE30054PV __	570	610	690	690	730	800	

\* 1 support bar included

\*\* 2 support bars included.

2+ 2 piece top with bars + table lock set included

# surfaces

PVEA 3mm eased edge and PVKN knife edge  
rectangle (con't)

For complete model number insert 2 character edge code:  
(PVEA for eased or PVKN for knife edge)



shape	dimension	model no.	PVEA eased			PVKN knife			
			A	B	C	A	B	C	
 rectangle	** 30 x 60	SLRE30060PV __	570	620	700	700	750	840	
	** 30 x 66	SLRE30066PV __	630	680	770	770	830	910	
	** 30 x 72	SLRE30072PV __	650	700	790	830	870	960	
	** 30 x 84	SLRE30084PV __	990	1,030	1,180	1,180	1,220	1,360	
	** 30 x 90	SLRE30090PV __	1,020	1,070	1,210	1,220	1,280	1,420	
	** 30 x 96	SLRE30096PV __	1,020	1,080	1,220	1,230	1,300	1,440	
		36 x 42	SLRE36042PV __	440	470	550	550	580	650
		36 x 48	SLRE36048PV __	480	530	610	620	650	740
	** 36 x 54	SLRE36054PV __	700	740	850	850	880	990	
	** 36 x 60	SLRE36060PV __	720	750	860	880	910	1,020	
	** 36 x 66	SLRE36066PV __	730	830	920	900	1,000	1,100	
	** 36 x 72	SLRE36072PV __	740	840	940	920	1,020	1,130	
	** 36 x 84	SLRE36084PV __	1,100	1,190	1,340	1,330	1,420	1,570	
	** 36 x 90	SLRE36090PV __	1,170	1,230	1,400	1,400	1,470	1,640	
	** 36 x 96	SLRE36096PV __	1,190	1,240	1,420	1,450	1,510	1,670	
	2+ 36 x 120	SLRE36120PV __	1,470	1,540	1,750	1,790	1,870	2,070	
	2+ 36 x 144	SLRE36144PV __	1,470	1,540	1,770	1,850	1,930	2,150	
		42 x 48	SLRE42048PV __	630	660	770	780	830	920
	** 42 x 54	SLRE42054PV __	740	770	890	900	940	1,060	
	** 42 x 60	SLRE42060PV __	890	940	1,080	1,080	1,130	1,280	
	** 42 x 66	SLRE42066PV __	960	1,080	1,230	1,170	1,290	1,440	
	** 42 x 72	SLRE42072PV __	990	1,120	1,290	1,210	1,340	1,510	
	** 42 x 84	SLRE42084PV __	1,330	1,510	1,740	1,600	1,770	1,990	
	** 42 x 90	SLRE42090PV __	1,360	1,570	1,780	1,650	1,850	2,070	
	** 42 x 96	SLRE42096PV __	1,360	1,580	1,790	1,660	1,880	2,090	
	2+ 42 x 120	SLRE42120PV __	1,770	1,900	2,180	2,150	2,280	2,550	
	2+ 42 x 144	SLRE42144PV __	1,940	2,050	2,380	2,390	2,500	2,830	
	** 48 x 54	SLRE48054PV __	890	940	1,080	1,080	1,130	1,280	
	** 48 x 60	SLRE48060PV __	890	940	1,080	1,100	1,160	1,300	
** 48 x 66	SLRE48066PV __	960	1,120	1,290	1,200	1,350	1,520		
** 48 x 72	SLRE48072PV __	960	1,120	1,290	1,220	1,380	1,540		
** 48 x 84	SLRE48084PV __	1,310	1,510	1,740	1,610	1,800	2,040		
** 48 x 90	SLRE48090PV __	1,350	1,570	1,780	1,670	1,890	2,100		
** 48 x 96	SLRE48096PV __	1,360	1,580	1,790	1,720	1,930	2,130		
2+ 48 x 120	SLRE48120PV __	1,870	1,960	2,230	2,290	2,390	2,660		
2+ 48 x 144	SLRE48144PV __	1,970	2,080	2,410	2,490	2,590	2,930		
2+ 48 x 168	SLRE48168PV __	2,520	2,650	3,030	3,110	3,250	3,620		
2+ 48 x 192	SLRE48192PV __	2,860	3,010	3,450	3,550	3,710	4,150		
** 60 x 66	SLRE60066PV __	1,290	1,350	1,550	1,580	1,650	1,850		
** 60 x 72	SLRE60072PV __	1,310	1,380	1,580	1,630	1,690	1,900		
** 60 x 84	SLRE60084PV __	1,740	1,830	2,090	2,110	2,210	2,480		
** 60 x 90	SLRE60090PV __	1,830	1,930	2,190	2,230	2,330	2,590		
** 60 x 96	SLRE60096PV __	1,840	1,940	2,200	2,270	2,370	2,630		
2+ 60 x 120	SLRE60120PV __	2,230	2,350	2,700	2,770	2,880	3,230		
2+ 60 x 144	SLRE60144PV __	2,410	2,540	2,960	3,060	3,180	3,600		
2+ 60 x 168	SLRE60168PV __	3,330	3,520	4,060	4,090	4,270	4,810		
2+ 60 x 192	SLRE60192PV __	3,430	3,610	4,160	4,290	4,470	5,020		

Additional edge profiles and top dimensions are available. Please contact Symphony for details.

Formica + Wilsonart HPL laminate finish grades listed on pages 20-27. For additional laminate grades, contact Symphony.

**Grain Match fees for 2 piece tops with a wood grain laminate**

See page 4 for upcharges

# surfaces

PVEA 3mm eased edge and PVKN knife edge  
conference: boat, racetrack

For complete model number insert 2 character edge code: (PVEA for eased or PVKN for knife edge)

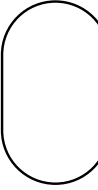
shape	dimension	model no.	PVEA eased			PVKN knife			
			A	B	C	A	B	C	
	** 36 x 72	SLBO36072PV __	790	840	940	990	1,020	1,130	
	** 36 x 84	SLBO36084PV __	1,130	1,190	1,340	1,350	1,420	1,570	
	** 36 x 96	SLBO36096PV __	1,190	1,240	1,420	1,450	1,510	1,670	
	2+ 36 x 120	SLBO36120PV __	1,540	1,630	1,830	1,870	1,950	2,150	
	** 42 x 96	SLBO42096PV __	1,500	1,580	1,790	1,790	1,880	2,090	
	** 48 x 96	SLBO48096PV __	1,520	1,610	1,820	1,870	1,950	2,170	
	2+ 48 x 120	SLBO48120PV __	1,990	2,100	2,370	2,420	2,530	2,790	
	** 60 x 96	SLBO60096PV __	1,840	1,940	2,200	2,270	2,370	2,630	
	2+ 60 x 120	SLBO60120PV __	2,390	2,520	2,860	2,930	3,060	3,400	
	2+ 60 x 144	SLBO60144PV __	2,410	2,540	2,960	3,060	3,180	3,600	
	2+ 60 x 168	SLBO60168PV __	3,330	3,520	4,060	4,090	4,270	4,810	
	2+ 60 x 192	SLBO60192PV __	3,470	3,650	4,190	4,320	4,500	5,050	
		** 36 x 72	SLRA36072PV __	780	830	920	980	1,010	1,120
		** 36 x 84	SLRA36084PV __	1,120	1,180	1,330	1,340	1,400	1,550
** 36 x 96		SLRA36096PV __	1,060	1,120	1,290	1,320	1,380	1,540	
2+ 36 x 120		SLRA36120PV __	1,470	1,540	1,750	1,790	1,870	2,070	
** 42 x 72		SLRA42072PV __	1,020	1,080	1,230	1,240	1,310	1,460	
** 42 x 96		SLRA42096PV __	1,380	1,450	1,660	1,670	1,750	1,960	
2+ 42 x 120		SLRA42120PV __	1,870	1,960	2,230	2,240	2,340	2,620	
** 48 x 96		SLRA48096PV __	1,400	1,470	1,680	1,750	1,820	2,040	
2+ 48 x 120		SLRA48120PV __	1,870	1,960	2,230	2,290	2,390	0	
2+ 48 x 144		SLRA48144PV __	1,970	2,080	2,410	2,490	2,590	2,930	
2+ 48 x 168		SLRA48168PV __	2,780	2,930	3,360	3,380	3,520	3,950	
2+ 48 x 192		SLRA48192PV __	2,860	3,010	3,450	3,550	3,710	4,150	
** 60 x 96		SLRA60096PV __	1,720	1,800	2,070	2,130	2,230	2,500	
2+ 60 x 120		SLRA60120PV __	2,230	2,350	2,700	2,770	2,880	3,230	
2+ 60 x 144	SLRA60144PV __	2,410	2,540	2,960	3,060	3,180	3,600		
2+ 60 x 168	SLRA60168PV __	3,330	3,520	4,060	4,090	4,270	4,810		
2+ 60 x 192	SLRA60192PV __	3,430	3,610	4,160	4,290	4,470	5,020		

Additional edge profiles and top dimensions are available. Please contact Symphony for details.

Formica + Wilsonart HPL laminate finish grades listed on pages 20-27. For additional laminate grades, contact Symphony.

\*1 support bar included    \*\* 2 support bars included    2+ 2 piece top with bars + table lock set included



Grain Match fees for 2 piece tops with a wood grain laminate

See page 4 for upcharges

# surfaces

PVEA 3mm eased edge and PVKN knife edge  
conference: oval, arc trapezoid, arc rectangle

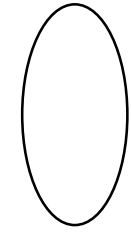
For complete model number insert 2 character edge code: (PVEA for eased or PVKN for knife edge)

shape	dimension	model no.	PVEA eased			PVKN knife		
			A	B	C	A	B	C
	** 36 x 72	SLOV36072PV __	780	830	920	980	1,010	1,120
	** 36 x 84	SLOV36084PV __	1,020	1,080	1,230	1,240	1,310	1,460
	** 36 x 96	SLOV36096PV __	1,060	1,120	1,290	1,320	1,380	1,540
	2+ 36 x 120	SLOV36120PV __	1,580	1,660	1,870	1,900	1,980	2,190
	** 42 x 72	SLOV42072PV __	1,020	1,080	1,230	1,240	1,310	1,460
	** 42 x 96	SLOV42096PV __	1,380	1,450	1,660	1,670	1,750	1,960
	** 48 x 96	SLOV48096PV __	1,400	1,470	1,680	1,750	1,820	2,040
	2+ 48 x 120	SLOV48120PV __	1,900	1,990	2,270	2,330	2,420	2,700
	2+ 48 x 144	SLOV48144PV __	1,960	2,070	2,390	2,480	2,570	2,900
	2+ 48 x 168	SLOV48168PV __	2,270	2,390	2,770	2,860	2,980	3,370
	** 60 x 96	SLOV60096PV __	1,800	1,900	2,170	2,230	2,330	2,590
	2+ 60 x 120	SLOV60120PV __	2,310	2,420	2,760	2,840	2,960	3,290
	2+ 60 x 144	SLOV60144PV __	2,420	2,550	2,970	3,070	3,200	3,610
	2+ 60 x 168	SLOV60168PV __	3,120	3,290	3,840	3,870	4,040	4,590
2+ 60 x 192	SLOV60192PV __	3,180	3,360	3,890	4,040	4,200	4,750	
	** 60 x 96	SLAT60096PV __	1,790	2,070	2,370	2,220	2,500	2,790
	2+ 60 x 120	SLAT60120PV __	2,350	2,680	3,070	2,880	3,220	3,600
	2+ 60 x 144	SLAT60144PV __	2,590	2,720	3,170	3,230	3,370	3,820
	2+ 60 x 168	SLAT60168PV __	3,580	3,760	4,360	4,320	4,510	5,100
	2+ 60 x 192	SLAT60192PV __	3,670	3,860	4,470	4,520	4,720	5,320
	** 48 x 72	SLAR48072PV __	1,050	1,120	1,290	1,310	1,380	1,540
	** 48 x 96	SLAR48096PV __	1,490	1,610	1,820	1,830	1,950	2,170
	2+ 48 x 120	SLAR48120PV __	1,870	1,960	2,230	2,290	2,390	2,660
	2+ 48 x 144	SLAR48144PV __	1,950	2,060	2,380	2,460	2,560	2,880
	2+ 48 x 168	SLAR48168PV __	2,490	2,620	2,990	3,080	3,210	3,590
	2+ 48 x 192	SLAR48192PV __	2,840	2,990	3,420	3,530	3,690	4,110
	** 60 x 96	SLAR60096PV __	1,800	1,940	2,200	2,230	2,370	2,630
	2+ 60 x 120	SLAR60120PV __	2,210	2,330	2,670	2,740	2,860	3,210
	2+ 60 x 144	SLAR60144PV __	2,410	2,540	2,960	3,060	3,180	3,600
	2+ 60 x 168	SLAR60168PV __	3,330	3,520	4,060	4,090	4,270	4,810
	2+ 60 x 192	SLAR60192PV __	3,470	3,650	4,190	4,320	4,500	5,050

Formica + Wilsonart HPL laminate finish grades listed on pages 20-27. For additional laminate grades, contact Symphony.

\* 1 support bar included    \*\* 2 support bars included.    2+ 2 piece top with bars + table lock set included

Grain Match fees for 2 piece tops with a wood grain laminate

See page 4 for upcharges



# surfaces

## PVEA 3mm eased edge and PVKN knife edge

media: half arced rectangle, half boat, trapezoid media, bullet media, pic

For complete model number:

1. insert 2 character top shape code (half arced rectangle **HR**, half boat **HB**, trapezoid media **TM**, or bullet media **BM**)
2. insert 2 character edge shape code (PVEA eased or PVKN knife)

For example 48" x 72" trapezoid media top #SL**TM**48072**PVEA**

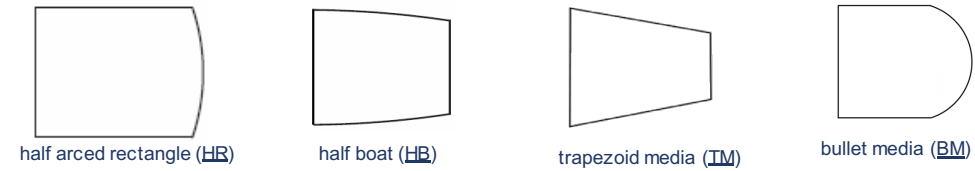

half arced rectangle (**HR**)

half boat (**HB**)

trapezoid media (**TM**)

bullet media (**BM**)



PVEA eased



PVKN knife

	dimensions	model no.	PVEA eased			PVKN knife		
			A	B	C	A	B	C
**	36 x 72	SL_36072PV	850	890	1,010	1,030	1,080	1,200
**	42 x 60	SL_42060PV	940	990	1,130	1,130	1,180	1,320
**	42 x 72	SL_42072PV	1,120	1,180	1,350	1,340	1,400	1,580
**	42 x 84	SL_42084PV	1,530	1,620	1,870	1,790	1,880	2,120
**	42 x 96	SL_42096PV	1,610	1,680	1,930	1,900	1,980	2,220
**	48 x 48	SL_48048PV	700	740	860	870	900	1,020
**	48 x 54	SL_48054PV	940	990	1,130	1,130	1,180	1,320
**	48 x 60	SL_48060PV	960	1,010	1,170	1,180	1,220	1,380
**	48 x 72	SL_48072PV	1,140	1,200	1,380	1,400	1,460	1,640
**	48 x 84	SL_48084PV	1,570	1,650	1,890	1,870	1,950	2,190
**	48 x 96	SL_48096PV	1,630	1,720	1,950	1,970	2,060	2,290
2+	48 x 120	SL_48120PV	1,980	2,090	2,400	2,410	2,520	2,830
2+	48 x 144	SL_48144PV	2,130	2,240	2,610	2,650	2,760	3,110
2+	48 x 168	SL_48168PV	2,960	3,110	3,590	3,550	3,710	4,180
2+	48 x 192	SL_48192PV	3,060	3,210	3,690	3,740	3,890	4,370
**	54 x 54	SL_54054PV	1,140	1,200	1,390	1,350	1,420	1,610
**	54 x 60	SL_54060PV	1,170	1,220	1,420	1,400	1,460	1,650
**	54 x 72	SL_54072PV	1,390	1,460	1,680	1,670	1,750	1,970
**	54 x 84	SL_54084PV	1,840	1,940	2,220	2,180	2,270	2,550
**	54 x 96	SL_54096PV	1,940	2,050	2,340	2,320	2,420	2,720
2+	54 x 120	SL_54120PV	2,380	2,500	2,870	2,860	2,980	3,370
2+	54 x 144	SL_54144PV	2,590	2,720	3,170	3,170	3,300	3,750
2+	54 x 168	SL_54168PV	3,540	3,730	4,330	4,210	4,410	5,020
2+	54 x 192	SL_54192PV	3,650	3,840	4,430	4,420	4,610	5,200
**	60 x 60	SL_60060PV	1,200	1,250	1,450	1,470	1,530	1,730
**	60 x 66	SL_60066PV	1,380	1,450	1,670	1,670	1,750	1,970
**	60 x 72	SL_60072PV	1,420	1,490	1,720	1,740	1,800	2,040
**	60 x 84	SL_60084PV	1,870	1,960	2,260	2,240	2,340	2,640
**	60 x 96	SL_60096PV	1,960	2,070	2,370	2,390	2,500	2,790
2+	60 x 120	SL_60120PV	2,390	2,520	2,900	2,930	3,060	3,430
2+	60 x 144	SL_60144PV	2,610	2,740	3,200	3,250	3,390	3,840
2+	60 x 168	SL_60168PV	3,580	3,760	4,360	4,320	4,510	5,100
2+	60 x 192	SL_60192PV	3,670	3,860	4,460	4,520	4,720	5,310
<b>Pic</b>	** 48 x 72	SLPI48072PV	1,130	1,190	1,360	1,390	1,450	1,630
	** 48 x 96	SLPI48096PV	1,600	1,670	1,900	1,940	2,020	2,240
	** 60 x 156	SLPI60156PV	3,270	3,430	3,970	3,970	4,140	4,660

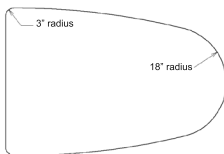

Formica + Wilsonart HPL laminate finish grades listed on pages 20-27. For additional laminate grades, contact Symphony.

\*1 support bar included    \*\* 2 support bars included    2+ 2 piece top with bars + table lock set included

Grain Match fees for 2 piece tops with a wood grain laminate

See page 4 for upcharges

SYMPHONY

2022 PRICE LIST

# surfaces

## PVEA 3mm eased edge

## additional shapes



PVEA eased

	dimensions	model no.	PVEA eased		
			A	B	C
quarter round	18 x 18	SLQR18018PVEA	120	130	150
	24 x 24	SLQR24024PVEA	180	190	230
	30 x 30	SLQR30030PVEA	280	290	330
half round	18 x 36	SLHA18036PVEA	240	250	290
	24 x 48	SLHA24048PVEA	390	410	470
	30 x 60	SLHA30060PVEA	590	630	730
crescent	18 x 36	SLCR18036PVEA	290	300	330
	24 x 48	SLCR24048PVEA	470	500	570
	24 x 60	SLCR24060PVEA	730	760	850
	30 x 60	SLCR30060PVEA	830	870	980
trapezoid	24 x 48	SLTR24048PVEA	390	410	470
	30 x 60	SLTR30060PVEA	590	630	730
	30 x 72	SLTR30072PVEA	840	880	1,000
corner - angled front	24 x 36	SLCA24036PVEA	400	440	510
	24 x 42	SLCA24042PVEA	590	640	750
	24 x 48	SLCA24048PVEA	630	660	770
corner - curved front	24 x 36	SLCC24036PVEA	400	440	510
	24 x 42	SLCC24042PVEA	590	640	750
	24 x 48	SLCC24048PVEA	630	660	770
corner - extended curved front	24 x 36 x 60	SLCE243660PVEA	840	880	1,000
	24 x 36 x 72	SLCE243672PVEA	950	1,000	1,160
	24 x 48 x 60	SLCE244860PVEA	1,060	1,120	1,290
	24 x 48 x 72	SLCE244872PVEA	1,240	1,310	1,510
	24 x 60 x 36***	SLCE246036PVEA	840	880	1,000
	24 x 72 x 36***	SLCE247236PVEA	950	1,000	1,160
	24 x 60 x 48***	SLCE246048PVEA	1,060	1,120	1,290
24 x 72 x 48***	SLCE247248PVEA	1,240	1,310	1,510	
corner - 120 degree	24 x 36	SL1224036PVEA	1,120	1,180	1,380
	24 x 42	SL1224042PVEA	1,460	1,530	1,800
	24 x 48	SL1224048PVEA	1,510	1,600	1,870
wedge	24 x 30 x 36	SLWE243036PVEA	340	390	450
	24 x 30 x 42	SLWE243042PVEA	450	500	580
	24 x 30 x 48	SLWE243048PVEA	460	510	590
	24 x 30 x 60***	SLWE243060PVEA	640	740	840
	30 x 24 x 36	SLWE302436PVEA	340	390	450
	30 x 24 x 42	SLWE302442PVEA	450	500	580
	30 x 24 x 48	SLWE302448PVEA	460	510	590
30 x 24 x 60***	SLWE302460PVEA	640	740	840	

\*\*\* top stiffeners may be required on corner - extended curved front or wedge tops over 48" long  
email [service@symphonytables.com](mailto:service@symphonytables.com) to confirm if you will need top stiffener(s),  
it will depend on the bases being used with the top

Formica + Wilsonart HPL laminate finish grades listed on pages 20-27. For additional laminate grades, contact Symphony.

\*1 support bar included    \*\* 2 support bars included    2+ 2 piece top with bars + table lock set included

SYMPHONY

2022 PRICE LIST

# surfaces

VNEA vinyl eased edge  
round, square, squircle, rectangle

VNEA eased

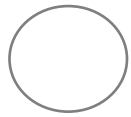
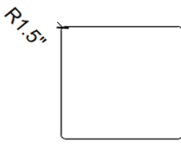
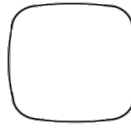
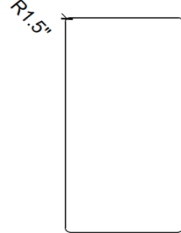
shape	dimension	model no.	A	B	C	
round 	18	SLRD18000VNEA	210	230	260	
	24	SLRD24000VNEA	240	250	290	
	30	SLRD30000VNEA	310	320	390	
	36	SLRD36000VNEA	410	430	500	
	42	SLRD42000VNEA	650	690	800	
	48	SLRD48000VNEA	690	730	840	
	54	SLRD54000VNEA	1,020	1,080	1,250	
	60	SLRD60000VNEA	1,080	1,140	1,320	
square 	18 x 18	SLSQ18018VNEA	210	230	260	
	24 x 24	SLSQ24024VNEA	240	250	290	
	30 x 30	SLSQ30030VNEA	310	320	390	
	36 x 36	SLSQ36036VNEA	410	430	500	
	42 x 42	SLSQ42042VNEA	650	690	800	
	48 x 48	SLSQ48048VNEA	690	730	840	
	54 x 54	SLSQ54054VNEA	1,020	1,080	1,250	
	60 x 60	SLSQ60060VNEA	1,080	1,140	1,320	
sqircle 	30 x 30	SLSC30030VNEA	310	320	390	
	36 x 36	SLSC36036VNEA	420	440	510	
	42 x 42	SLSC42042VNEA	650	690	800	
	48 x 48	SLSC48048VNEA	690	730	840	
	54 x 54	SLSC54054VNEA	1,020	1,080	1,250	
	60 x 60	SLSC60060VNEA	1,080	1,140	1,320	
rectangle 	18 x 36	SLRE18036VNEA	300	310	360	
	18 x 42	SLRE18042VNEA	340	350	420	
	18 x 48	SLRE18048VNEA	340	350	420	
	* 18 x 54	SLRE18054VNEA	480	510	580	
	* 18 x 60	SLRE18060VNEA	460	480	560	
	* 18 x 66	SLRE18066VNEA	510	540	620	
	* 18 x 72	SLRE18072VNEA	530	550	630	
	* 18 x 84	SLRE18084VNEA	700	740	850	
	* 18 x 90	SLRE18090VNEA	740	770	890	
	* 18 x 96	SLRE18096VNEA	760	790	910	
		24 x 30	SLRE24030VNEA	280	290	330
		24 x 36	SLRE24036VNEA	310	320	360
		24 x 42	SLRE24042VNEA	330	340	410
		24 x 48	SLRE24048VNEA	340	360	440
	* 24 x 54	SLRE24054VNEA	500	530	610	
	* 24 x 60	SLRE24060VNEA	500	530	590	
	* 24 x 66	SLRE24066VNEA	530	550	630	
	* 24 x 72	SLRE24072VNEA	550	570	650	
	* 24 x 84	SLRE24084VNEA	750	770	880	
	* 24 x 90	SLRE24090VNEA	770	800	910	
* 24 x 96	SLRE24096VNEA	780	830	940		

Formica + Wilsonart HPL laminate finish grades listed on pages 20-27. For additional laminate grades, contact Symphony

\*1 support bar included    \*\* 2 support bars included    2+ 2 piece top with bars + table lock set included

# surfaces

VNEA vinyl eased edge  
rectangle (con't)

VNEA eased

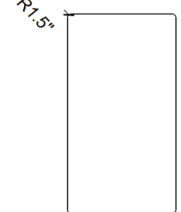
shape	dimension	model no.	A	B	C	
rectangle 	30 x 36	SLRE30036VNEA	390	410	460	
	30 x 42	SLRE30042VNEA	410	430	500	
	30 x 48	SLRE30048VNEA	430	450	540	
	** 30 x 54	SLRE30054VNEA	590	630	730	
	** 30 x 60	SLRE30060VNEA	620	650	740	
	** 30 x 66	SLRE30066VNEA	680	720	800	
	** 30 x 72	SLRE30072VNEA	700	740	850	
	** 30 x 84	SLRE30084VNEA	1,020	1,080	1,230	
	** 30 x 90	SLRE30090VNEA	1,060	1,120	1,280	
	** 30 x 96	SLRE30096VNEA	1,070	1,130	1,290	
		36 x 42	SLRE36042VNEA	470	500	580
		36 x 48	SLRE36048VNEA	540	560	640
	** 36 x 54	SLRE36054VNEA	740	770	880	
	** 36 x 60	SLRE36060VNEA	750	780	890	
	** 36 x 66	SLRE36066VNEA	800	860	990	
** 36 x 72	SLRE36072VNEA	830	870	1,000		
** 36 x 84	SLRE36084VNEA	1,190	1,240	1,420		
** 36 x 90	SLRE36090VNEA	1,230	1,300	1,470		
** 36 x 96	SLRE36096VNEA	1,240	1,310	1,490		
2+ 36 x 120	SLRE36120VNEA	1,530	1,620	1,830		
	42 x 48	SLRE42048VNEA	660	700	830	
** 42 x 54	SLRE42054VNEA	780	830	920		
** 42 x 60	SLRE42060VNEA	940	990	1,140		
** 42 x 66	SLRE42066VNEA	1,080	1,140	1,310		
** 42 x 72	SLRE42072VNEA	1,120	1,180	1,350		
** 42 x 84	SLRE42084VNEA	1,510	1,600	1,820		
** 42 x 90	SLRE42090VNEA	1,550	1,640	1,880		
** 42 x 96	SLRE42096VNEA	1,570	1,650	1,890		
2+ 42 x 120	SLRE42120VNEA	1,900	1,990	2,280		
2+ 42 x 144	SLRE42144VNEA	2,060	2,170	2,510		
** 48 x 54	SLRE48054VNEA	940	990	1,140		
** 48 x 60	SLRE48060VNEA	950	990	1,140		
** 48 x 66	SLRE48066VNEA	1,120	1,180	1,350		
** 48 x 72	SLRE48072VNEA	1,120	1,180	1,350		
** 48 x 84	SLRE48084VNEA	1,510	1,600	1,820		
** 48 x 90	SLRE48090VNEA	1,550	1,640	1,880		
** 48 x 96	SLRE48096VNEA	1,570	1,650	1,890		
2+ 48 x 120	SLRE48120VNEA	1,950	2,060	2,340		
2+ 48 x 144	SLRE48144VNEA	2,090	2,200	2,540		
** 60 x 66	SLRE60090VNEA	1,350	1,430	1,640		
** 60 x 72	SLRE60090VNEA	1,380	1,450	1,670		
** 60 x 84	SLRE60084VNEA	1,830	1,930	2,210		
** 60 x 90	SLRE60090VNEA	1,930	2,020	2,310		
** 60 x 96	SLRE60096VNEA	1,930	2,040	2,320		
2+ 60 x 120	SLRE60120VNEA	2,350	2,480	2,840		
2+ 60 x 144	SLRE60144VNEA	2,550	2,680	3,120		

Additional edge profiles and top dimensions are available. Please contact Symphony for details.

\*1 support bar included    \*\* 2 support bars included    2+ 2 piece top with bars + table lock set included

Grain Match fees for 2 piece tops with a wood grain laminate

See page 4 for upcharges

# surfaces

VNEA vinyl eased edge  
conference: boat, racetrack, oval

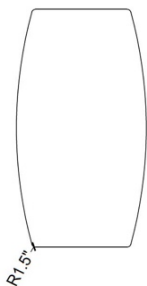
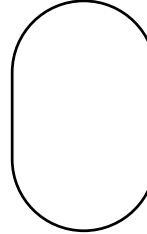
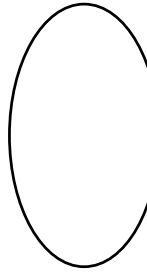
shape	dimension	model no.	VNEA eased (1.5" radius corners)			
			A	B	C	
	** 36 x 72	SLBO36072VNEA	830	870	1,000	
	** 36 x 84	SLBO36084VNEA	1,190	1,240	1,420	
	** 36 x 96	SLBO36096VNEA	1,240	1,310	1,490	
	<b>2+</b> 36 x 120	SLBO36120VNEA	1,620	1,690	1,910	
	** 42 x 96	SLBO42096VNEA	1,580	1,650	1,890	
	** 48 x 96	SLBO48096VNEA	1,600	1,670	1,910	
	<b>2+</b> 48 x 120	SLBO48120VNEA	2,090	2,200	2,490	
	** 60 x 96	SLBO60096VNEA	1,930	2,040	2,320	
	<b>2+</b> 60 x 120	SLBO60120VNEA	2,510	2,640	3,000	
	<b>2+</b> 60 x 144	SLBO60144VNEA	2,550	2,680	3,120	
		** 36 x 72	SLRA36072VNEA	800	860	990
		** 36 x 84	SLRA36084VNEA	1,180	1,230	1,400
** 36 x 96		SLRA36096VNEA	1,120	1,180	1,350	
<b>2+</b> 36 x 120		SLRA36120VNEA	1,530	1,620	1,830	
** 42 x 72		SLRA42072VNEA	1,080	1,140	1,310	
** 42 x 96		SLRA42096VNEA	1,450	1,520	1,760	
<b>2+</b> 42 x 120		SLRA42120VNEA	1,980	2,060	2,340	
** 48 x 96		SLRA48096VNEA	1,470	1,540	1,780	
<b>2+</b> 48 x 120		SLRA48120VNEA	1,950	2,060	2,340	
<b>2+</b> 48 x 144		SLRA48144VNEA	2,090	2,200	2,540	
** 60 x 96		SLRA60096VNEA	1,800	1,900	2,190	
<b>2+</b> 60 x 120		SLRA60120VNEA	2,350	2,480	2,840	
<b>2+</b> 60 x 144	SLRA60144VNEA	2,550	2,680	3,120		
	** 36 x 72	SLOV36072VNEA	800	860	990	
	** 36 x 84	SLOV36084VNEA	1,080	1,140	1,310	
	** 36 x 96	SLOV36096VNEA	1,120	1,180	1,350	
	<b>2+</b> 36 x 120	SLOV36120VNEA	1,650	1,740	1,950	
	** 42 x 72	SLOV42072VNEA	1,080	1,140	1,310	
	** 42 x 96	SLOV42096VNEA	1,450	1,520	1,760	
	** 48 x 96	SLOV48096VNEA	1,470	1,540	1,780	
	<b>2+</b> 48 x 120	SLOV48120VNEA	1,980	2,090	2,380	
	<b>2+</b> 48 x 144	SLOV48144VNEA	2,070	2,180	2,530	
	** 60 x 96	SLOV60096VNEA	1,900	1,990	2,280	
	<b>2+</b> 60 x 120	SLOV60120VNEA	2,410	2,540	2,900	
	<b>2+</b> 60 x 144	SLOV60144VNEA	2,560	2,700	3,140	

Formica + Wilsonart HPL laminate finish grades listed on pages 20-27. For additional laminate grades, contact Symphony

\*1 support bar included    \*\* 2 support bars included    2+ 2 piece top with bars + table lock set included

# surfaces

VNEA vinyl eased edge  
media: half arced rectangle, half boat, trapezoid media, bullet media

For complete model number  
1. insert 2 character top shape code  
(half arced rectangle **HR**, half boat **HB**, trapezoid media **TM**, bullet media - **BM**)  
For example 48" x 72" trapezoid media top with vinyl edge #SL**TM**48072VNEA

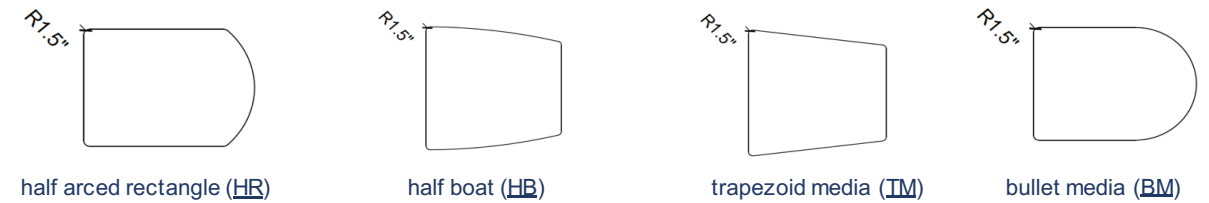

dimensions	model no.	VNEA eased		
		A	B	C
** 36 x 72	SL_36072VNEA	880	920	1,070
** 42 x 60	SL_42060VNEA	990	1,030	1,200
** 42 x 72	SL_42072VNEA	1,180	1,230	1,430
** 42 x 84	SL_42084VNEA	1,630	1,720	1,960
** 42 x 96	SL_42096VNEA	1,680	1,770	2,020
** 48 x 48	SL_48048VNEA	750	780	900
** 48 x 54	SL_48054VNEA	990	1,030	1,200
** 48 x 60	SL_48060VNEA	1,010	1,060	1,220
** 48 x 72	SL_48072VNEA	1,200	1,250	1,450
** 48 x 84	SL_48084VNEA	1,650	1,740	1,980
** 48 x 96	SL_48096VNEA	1,690	1,790	2,060
<b>2+</b> 48 x 120	SL_48120VNEA	2,090	2,200	2,520
<b>2+</b> 48 x 144	SL_48144VNEA	2,240	2,370	2,760
** 54 x 54	SL_54054VNEA	1,210	1,280	1,470
** 54 x 60	SL_54060VNEA	1,230	1,300	1,500
** 54 x 72	SL_54072VNEA	1,460	1,530	1,770
** 54 x 84	SL_54084VNEA	1,930	2,040	2,350
** 54 x 96	SL_54096VNEA	2,040	2,130	2,460
<b>2+</b> 54 x 120	SL_54120VNEA	2,500	2,630	3,030
<b>2+</b> 54 x 144	SL_54144VNEA	2,730	2,870	3,370
** 60 x 60	SL_60060VNEA	1,240	1,320	1,520
** 60 x 66	SL_60066VNEA	1,450	1,520	1,760
** 60 x 72	SL_60072VNEA	1,470	1,550	1,800
** 60 x 84	SL_60084VNEA	1,960	2,070	2,380
** 60 x 96	SL_60096VNEA	2,070	2,180	2,500
<b>2+</b> 60 x 120	SL_60120VNEA	2,530	2,660	3,060
<b>2+</b> 60 x 144	SL_60144VNEA	2,770	2,920	3,390

Additional edge profiles and top dimensions are available. Please contact Symphony for details.

Formica + Wilsonart HPL laminate finish grades listed on pages 20-27. For additional laminate grades, contact Symphony



\*1 support bar included    \*\* 2 support bars included    2+ 2 piece top with bars + table lock set included

**Grain Match fees for 2 piece tops with a wood grain laminate**

See page 4 for upcharges

# surfaces

laptop & occasional PVEA, PVRC, PVKN & PVKR  
round, square, rectangle

shape	dimension	model no.	PVEA eased with 90 degree corners			PVRC eased with 3" radius corners			PVKN knife with 90 degree corners			PVKR knife with 3" radius corners		
			A	B	C	A	B	C	A	B	C	A	B	C
 round	18	SLRD18000PV __	200	210	250				230	240	280			
	20	SLRD20000PV __	200	240	280				250	290	320			
	24	SLRD24000PV __	200	240	280				250	290	320			
	30	SLRD30000PV __	290	310	350				350	390	430			
	36	SLRD36000PV __	340	410	460				440	500	560			
	42	SLRD42000PV __	580	650	760				720	780	890			
	48	SLRD48000PV __	590	680	790				760	850	960			
 square	18 x 18	SLSQ18018PV __	200	210	250	230	240	280	230	240	280	250	260	290
	20 x 20	SLSQ20020PV __	200	240	280	250	290	320	250	290	320	260	280	300
	24 x 24	SLSQ24024PV __	200	240	280	250	290	320	250	290	320	280	290	310
	30 x 30	SLSQ30030PV __	290	310	350	310	320	360	350	390	430	360	390	420
	36 x 36	SLSQ36036PV __	340	410	460	410	420	470	440	500	560	480	500	560
	42 x 42	SLSQ42042PV __	580	650	760	630	640	770	720	780	890	750	760	860
 rectangle	12 x 18	SLRE12018PV __	200	210	250	230	240	280	230	240	280	250	260	290
	14 x 20	SLRE14020PV __	200	240	280	250	290	320	250	290	320	260	280	300

Formica + Wilsonart HPL laminate finish grades listed on pages 22-29. For additional laminate grades, contact Symphony



# bases



# bases

T fixed single column sets

Keller, Ria, Rosanno





base	base dim.	max top support	base set qty	base set model no.	list	glides or casters	finish
Keller 	15	20 x 96	2	BTKEL20096SDGME	750	adj glides	standard metal
	20	24 x 96	2	BTKEL24096SDGME	770	adj glides	standard metal
	26	36 x 96	2	BTKEL36096SDGME	850	adj glides	standard metal
	33	42 x 96	2	BTKEL42096SDGME	980	adj glides	standard metal
	38	48 x 96	2	BTKEL48096SDGME	1,130	adj glides	standard metal
	15	20 x 96	2	BTKEL20096SDCME	840	2" black locking casters	standard metal
	20	24 x 96	2	BTKEL24096SDCME	860	2" black locking casters	standard metal
	26	36 x 96	2	BTKEL36096SDCME	940	2" black locking casters	standard metal
	33	42 x 96	2	BTKEL42096SDCME	1,070	2" black locking casters	standard metal
	38	48 x 96	2	BTKEL48096SDCME	1,220	2" black locking casters	standard metal
	15	20 x 96	2	BTKEL20096SDGPO	880	adj glides	polished
	20	24 x 96	2	BTKEL24096SDGPO	900	adj glides	polished
	26	36 x 96	2	BTKEL36096SDGPO	980	adj glides	polished
	33	42 x 96	2	BTKEL42096SDGPO	1,110	adj glides	polished
	38	48 x 96	2	BTKEL48096SDGPO	1,270	adj glides	polished
	15	20 x 96	2	BTKEL20096SDCPO	970	2" black locking casters	polished
	20	24 x 96	2	BTKEL24096SDCPO	990	2" black locking casters	polished
	26	36 x 96	2	BTKEL36096SDCPO	1,070	2" black locking casters	polished
33	42 x 96	2	BTKEL42096SDCPO	1,200	2" black locking casters	polished	
38	48 x 96	2	BTKEL48096SDCPO	1,350	2" black locking casters	polished	
Ria 	15	20 x 96	2	BTRIA20096SDGME	640	adj glides	standard metal
	20	24 x 96	2	BTRIA24096SDGME	660	adj glides	standard metal
	26	36 x 96	2	BTRIA36096SDGME	690	adj glides	standard metal
	33	42 x 96	2	BTRIA42096SDGME	840	adj glides	standard metal
	38	48 x 96	2	BTRIA48096SDGME	1,020	adj glides	standard metal
	15	20 x 96	2	BTRIA20096SDCME	730	2" black locking casters	standard metal
	20	24 x 96	2	BTRIA24096SDCME	750	2" black locking casters	standard metal
	26	36 x 96	2	BTRIA36096SDCME	780	2" black locking casters	standard metal
	33	42 x 96	2	BTRIA42096SDCME	920	2" black locking casters	standard metal
	38	48 x 96	2	BTRIA48096SDCME	1,110	2" black locking casters	standard metal
	15	20 x 96	2	BTRIA20096SDGPO	770	adj glides	polished
	20	24 x 96	2	BTRIA24096SDGPO	790	adj glides	polished
	26	36 x 96	2	BTRIA36096SDGPO	830	adj glides	polished
	33	42 x 96	2	BTRIA42096SDGPO	970	adj glides	polished
	38	48 x 96	2	BTRIA48096SDGPO	1,160	adj glides	polished
	15	20 x 96	2	BTRIA20096SDCPO	860	2" black locking casters	polished
	20	24 x 96	2	BTRIA24096SDCPO	880	2" black locking casters	polished
	26	36 x 96	2	BTRIA36096SDCPO	910	2" black locking casters	polished
33	42 x 96	2	BTRIA42096SDCPO	1,060	2" black locking casters	polished	
38	48 x 96	2	BTRIA48096SDCPO	1,240	2" black locking casters	polished	
Rosanno 	16	20 x 96	2	BTROS20096SDGME	640	adj glides	standard metal
	22	30 x 96	2	BTROS30096SDGME	660	adj glides	standard metal
	26	36 x 96	2	BTROS36096SDGME	690	adj glides	standard metal
	16	20 x 96	2	BTROS20096SDCME	730	2" black locking casters	standard metal
	22	30 x 96	2	BTROS30096SDCME	750	2" black locking casters	standard metal
	26	36 x 96	2	BTROS36096SDCME	780	2" black locking casters	standard metal
	16	20 x 96	2	BTROS20096SDGPC	990	adj glides	polished
	22	30 x 96	2	BTROS30096SDGPC	1,010	adj glides	polished
	26	36 x 96	2	BTROS36096SDGPC	1,050	adj glides	polished
	16	20 x 96	2	BTROS20096SDCPC	1,080	2" black locking casters	polished
	22	30 x 96	2	BTROS30096SDCPC	1,100	2" black locking casters	polished
	26	36 x 96	2	BTROS36096SDCPC	1,130	2" black locking casters	polished

Custom height bases for Keller, Ria, Moto, and Novi only - + \$150 list  
 Custom lower and taller fixed height options are available for single column tables with a top size up to 36 x 72.  
 For a custom lower height, replace the "SD" in the model number for "SL"

# bases

T fixed single column sets

Novi, Zoey, Moto, Moto 2

base	base dim.	max top support	base set qty	base set model no.	list	glide/caster	finish
Novi 	18	20 x 96	2	BTNOV20096SDGME	620	adj glides	standard metal
	22	30 x 96	2	BTNOV30096SDGME	640	adj glides	standard metal
	26	36 x 96	2	BTNOV36096SDGME	660	adj glides	standard metal
	32	42 x 96	2	BTNOV42096SDGME	840	adj glides	standard metal
	18	20 x 96	2	BTNOV20096SDCME	700	2" black locking casters	standard metal
	22	30 x 96	2	BTNOV30096SDCME	730	2" black locking casters	standard metal
	26	36 x 96	2	BTNOV36096SDCME	750	2" black locking casters	standard metal
	32	42 x 96	2	BTNOV42096SDCME	920	2" black locking casters	standard metal
	18	20 x 96	2	BTNOV20096SDHME	730	glides/concealed casters	standard metal
	22	30 x 96	2	BTNOV30096SDHME	750	glides/concealed casters	standard metal
	26	36 x 96	2	BTNOV36096SDHME	770	glides/concealed casters	standard metal
	32	42 x 96	2	BTNOV42096SDHME	950	glides/concealed casters	standard metal
	18	20 x 96	2	BTNOV20096SDGPC	860	adj glides	polished
	22	30 x 96	2	BTNOV30096SDGPC	880	adj glides	polished
	26	36 x 96	2	BTNOV36096SDGPC	900	adj glides	polished
	18	20 x 96	2	BTNOV20096SDCPC	950	2" black locking casters	polished
	22	30 x 96	2	BTNOV30096SDCPC	970	2" black locking casters	polished
	26	36 x 96	2	BTNOV36096SDCPC	990	2" black locking casters	polished
Zoey 	15	20 x 96	2	BTZOE20096SDGME	570	adj glides	standard metal
	21	24 x 96	2	BTZOE24096SDGME	590	adj glides	standard metal
	27	36 x 96	2	BTZOE36096SDGME	640	adj glides	standard metal
	33	42 x 96	2	BTZOE42096SDGME	690	adj glides	standard metal
	15	20 x 96	2	BTZOE20096SDCME	660	3" black locking casters	standard metal
	21	24 x 96	2	BTZOE24096SDCME	680	3" black locking casters	standard metal
	27	36 x 96	2	BTZOE36096SDCME	730	3" black locking casters	standard metal
	33	42 x 96	2	BTZOE42096SDCME	780	3" black locking casters	standard metal
	15	20 x 96	2	BTZOE20096SDPME	700	3" premium locking casters	standard metal
	21	24 x 96	2	BTZOE24096SDPME	730	3" premium locking casters	standard metal
	27	36 x 96	2	BTZOE36096SDPME	770	3" premium locking casters	standard metal
	33	42 x 96	2	BTZOE42096SDPME	830	3" premium locking casters	standard metal
Moto 	18	24 x 96	2	BTMOT24096SDGME	780	adj glides	standard metal
	22	30 x 96	2	BTMOT30096SDGME	840	adj glides	standard metal
	26	36 x 96	2	BTMOT36096SDGME	890	adj glides	standard metal
	18	24 x 96	2	BTMOT24096SDCME	870	2" black locking casters	standard metal
	22	30 x 96	2	BTMOT30096SDCME	920	2" black locking casters	standard metal
	26	36 x 96	2	BTMOT36096SDCME	980	2" black locking casters	standard metal
Moto 2 	18	24 x 96	2	BTMO224096SDGME	620	adj glides	standard metal
	22	30 x 96	2	BTMO230096SDGME	640	adj glides	standard metal
	26	36 x 96	2	BTMO236096SDGME	690	adj glides	standard metal
	18	24 x 96	2	BTMO224096SDCME	700	2" black locking casters	standard metal
	22	30 x 96	2	BTMO230096SDCME	730	2" black locking casters	standard metal
	26	36 x 96	2	BTMO236096SDCME	780	2" black locking casters	standard metal
	18	24 x 96	2	BTMO224096SDPME	750	2" premium locking casters	standard metal
	22	30 x 96	2	BTMO230096SDPME	770	2" premium locking casters	standard metal
	26	36 x 96	2	BTMO236096SDPME	830	2" premium locking casters	standard metal

-  **C casters**  
 2" black dual wheel locking (all bases except Zoey)  
 3" black dual wheel locking (Zoey)
-  **P premium casters**  
 3" white dual wheel locking (Zoey)  
 2" silver/black dual wheel locking - (Moto, Moto 2)
-  **H Novi hidden/concealed casters**

**Standard metal powder coat finishes (ME):**  
 Black Wrinkle, Chateau Brown Wrinkle, Flat Black, Furniture White, Inner Tone, Light Tone, Medium Tone, and Metallic Silver







**(PO) Polished aluminum / chrome finish (Keller / Ria)**  
**(PC) Polished chrome finish (Rosanno / Novi)**

Note that the fixed T bases cannot be spread more than 50" apart at center.

# bases

T fixed double column sets

Keller, Ria, Rosanno, Novi, Moto, Zoey

base	base dim.	max top support	base set qty	base set model no.	list	glides	finish
	34	48 x 96	2	BTKEL480962DGME	1,310	adj glides	standard metal
	34	48 x 144	3	BTKEL481442DGME	1,970	adj glides	standard metal
	34	48 x 192	4	BTKEL481922DGME	2,630	adj glides	standard metal
	40	60 x 96	2	BTKEL600962DGME	1,430	adj glides	standard metal
	40	60 x 144	3	BTKEL601442DGME	2,130	adj glides	standard metal
	40	60 x 192	4	BTKEL601922DGME	2,850	adj glides	standard metal
	34	48 x 96	2	BTKEL480962DGPO	1,600	adj glides	polished
	34	48 x 144	3	BTKEL481442DGPO	2,400	adj glides	polished
	34	48 x 192	4	BTKEL481922DGPO	3,200	adj glides	polished
	40	60 x 96	2	BTKEL600962DGPO	1,720	adj glides	polished
	34	48 x 96	2	BTRIA480962DGME	1,090	adj glides	standard metal
	34	48 x 144	3	BTRIA481442DGME	1,640	adj glides	standard metal
	34	48 x 192	4	BTRIA481922DGME	2,350	adj glides	standard metal
	40	60 x 96	2	BTRIA600962DGME	1,190	adj glides	standard metal
	40	60 x 144	3	BTRIA601442DGME	1,770	adj glides	standard metal
	40	60 x 192	4	BTRIA601922DGME	2,520	adj glides	standard metal
	34	48 x 96	2	BTRIA480962DGPO	1,380	adj glides	polished
	34	48 x 144	3	BTRIA481442DGPO	2,070	adj glides	polished
	34	48 x 192	4	BTRIA481922DGPO	2,930	adj glides	polished
	40	60 x 96	2	BTRIA600962DGPO	1,470	adj glides	polished
	36	48 x 96	2	BTROS480962DGME	1,250	adj glides	standard metal
	36	48 x 144	3	BTROS481442DGME	1,880	adj glides	standard metal
	36	48 x 192	4	BTROS481922DGME	2,510	adj glides	standard metal
	36	48 x 96	2	BTNOV480962DGME	1,020	adj glides	standard metal
	36	48 x 144	3	BTNOV481442DGME	1,530	adj glides	standard metal
	42	60 x 96	2	BTNOV600962DGME	1,100	adj glides	standard metal
	42	60 x 144	3	BTNOV601442DGME	1,660	adj glides	standard metal
	26	36 x 96	2	BTMOT360962DGME	1,250	adj glides	standard metal
	26	36 x 144	3	BTMOT361442DGME	1,890	adj glides	standard metal
	32	42 x 96	2	BTMOT420962DGME	1,330	adj glides	standard metal
	32	42 x 144	3	BTMOT421442DGME	1,990	adj glides	standard metal
	32	42 x 192	4	BTMOT421922DGME	2,660	adj glides	standard metal
	36	48 x 96	2	BTMOT480962DGME	1,430	adj glides	standard metal
	36	48 x 144	3	BTMOT481442DGME	2,130	adj glides	standard metal
	36	48 x 192	4	BTMOT481922DGME	2,850	adj glides	standard metal
	38	48 x 96	2	BTZOE480962DGME	1,310	adj glides	standard metal
	38	48 x 144	3	BTZOE481442DGME	1,960	adj glides	standard metal
	38	48 x 192	4	BTZOE481922DGME	2,620	adj glides	standard metal
	47	60 x 96	2	BTZOE600962DGME	1,430	adj glides	standard metal
	47	60 x 144	3	BTZOE601442DGME	2,130	adj glides	standard metal
	47	60 x 192	4	BTZOE601922DGME	2,850	adj glides	standard metal

Note that double column T bases cannot be spread more than 50" apart at center.

Standard metal powder coat finishes (ME):  
Black Wrinkle, Chateau Brown Wrinkle, Flat Black, Furniture White, Inner Tone, Light Tone, Medium Tone, and Metallic Silver





(PQ) Polished aluminum / chrome finish (Keller / Ria)

(PC) Polished chrome finish (Rosanno / Novi)

# bases

T nesting sets

Novi Double Column, Keller, Ria, Rosanno, Novi

base	base dim.	max top support	base set qty	base set model no.	list	glides or casters	finish
Novi Double Column with Nester Series beam	32	48 x 48, 60rd	2	BTNOV480482NCME	2,210	3" black locking casters	standard metal
	15	20 x 72	2	BTKEL20072NEGME	1,240	adj glides	standard metal
	20	24 x 72	2	BTKEL24072NEGME	1,290	adj glides	standard metal
	26	36 x 72	2	BTKEL36072NEGME	1,340	adj glides	standard metal
	15	20 x 72	2	BTKEL20072NECME	1,330	2" black locking casters	standard metal
	20	24 x 72	2	BTKEL24072NECME	1,380	2" black locking casters	standard metal
	26	36 x 72	2	BTKEL36072NECME	1,430	2" black locking casters	standard metal
	15	20 x 72	2	BTKEL20072NEGPO	1,380	adj glides	polished
	20	24 x 72	2	BTKEL24072NEGPO	1,420	adj glides	polished
	26	36 x 72	2	BTKEL36072NEGPO	1,470	adj glides	polished
	15	20 x 72	2	BTKEL20072NECPO	1,460	2" black locking casters	polished
	20	24 x 72	2	BTKEL24072NECPO	1,510	2" black locking casters	polished
	26	36 x 72	2	BTKEL36072NECPO	1,560	2" black locking casters	polished
	15	20 x 72	2	BTRIA20072NEGME	1,170	adj glides	standard metal
	20	24 x 72	2	BTRIA24072NEGME	1,180	adj glides	standard metal
	26	36 x 72	2	BTRIA36072NEGME	1,220	adj glides	standard metal
	15	20 x 72	2	BTRIA20072NECME	1,250	2" black locking casters	standard metal
	20	24 x 72	2	BTRIA24072NECME	1,270	2" black locking casters	standard metal
	26	36 x 72	2	BTRIA36072NECME	1,310	2" black locking casters	standard metal
	15	20 x 72	2	BTRIA20072NEGPO	1,300	adj glides	polished
	20	24 x 72	2	BTRIA24072NEGPO	1,310	adj glides	polished
	26	36 x 72	2	BTRIA36072NEGPO	1,350	adj glides	polished
	15	20 x 72	2	BTRIA20072NECPO	1,390	2" black locking casters	polished
	20	24 x 72	2	BTRIA24072NECPO	1,400	2" black locking casters	polished
	26	36 x 72	2	BTRIA36072NECPO	1,440	2" black locking casters	polished
	18	20 x 72	2	BTROS20072NEGME	1,170	adj glides	standard metal
	22	30 x 72	2	BTROS30072NEGME	1,180	adj glides	standard metal
	26	36 x 72	2	BTROS36072NEGME	1,210	adj glides	standard metal
	18	20 x 72	2	BTROS20072NECME	1,250	2" black locking casters	standard metal
	22	30 x 72	2	BTROS30072NECME	1,270	2" black locking casters	standard metal
	26	36 x 72	2	BTROS36072NECME	1,300	2" black locking casters	standard metal
	18	20 x 72	2	BTNOV20072NEGME	1,130	adj glides	standard metal
	22	30 x 72	2	BTNOV30072NEGME	1,140	adj glides	standard metal
	26	36 x 72	2	BTNOV36072NEGME	1,180	adj glides	standard metal
	18	20 x 72	2	BTNOV20072NECME	1,220	2" black locking casters	standard metal
	22	30 x 72	2	BTNOV30072NECME	1,230	2" black locking casters	standard metal
	26	36 x 72	2	BTNOV36072NECME	1,270	2" black locking casters	standard metal
	18	20 x 72	2	BTNOV20072NEHME	1,240	glides/concealed casters	standard metal
	22	30 x 72	2	BTNOV30072NEHME	1,250	glides/concealed casters	standard metal
	26	36 x 72	2	BTNOV36072NEHME	1,290	glides/concealed casters	standard metal

KELLER, RIA, ROSANNO AND NOVI SINGLE T FLIP MECH IMAGE:



C casters  
2" black dual wheel locking (single column flip.nest bases)



H Novi hidden/concealed casters  
one T base per set has glides, the other base has hidden/concealed casters



Standard metal powder coat finishes (ME):  
Black Wrinkle, Chateau Brown Wrinkle, Flat Black, Furniture White, Inner Tone, Light Tone, Medium Tone, and Metallic Silver

(PQ) Polished aluminum / chrome finish (Keller / Ria)

\*bases cannot be spread more than 50" apart at center



# bases

## T nesting sets

### Zoey

base	base dim.	max top support	base set qty	base set model no.	list	glides or casters	finish
Zoey with beam	15	20 x 60	2	BTZOE20060NBGM	1,240	adj glides	standard metal
	21	24 x 60	2	BTZOE24060NBGM	1,280	adj glides	standard metal
	27	30 x 60	2	BTZOE30060NBGM	1,300	adj glides	standard metal
	33	36 x 60	2	BTZOE36060NBGM	1,340	adj glides	standard metal
	15	20 x 72	2	BTZOE20072NBGM	1,290	adj glides	standard metal
	21	24 x 72	2	BTZOE24072NBGM	1,310	adj glides	standard metal
	27	30 x 72	2	BTZOE30072NBGM	1,330	adj glides	standard metal
	33	36 x 72	2	BTZOE36072NBGM	1,390	adj glides	standard metal
	15	20 x 60	2	BTZOE20060NBCM	1,240	3" black locking casters	standard metal
	21	24 x 60	2	BTZOE24060NBCM	1,280	3" black locking casters	standard metal
	27	30 x 60	2	BTZOE30060NBCM	1,300	3" black locking casters	standard metal
	33	36 x 60	2	BTZOE36060NBCM	1,340	3" black locking casters	standard metal
without beam	15	20 x 72	2	BTZOE20072NBCM	1,290	3" black locking casters	standard metal
	21	24 x 72	2	BTZOE24072NBCM	1,310	3" black locking casters	standard metal
	27	30 x 72	2	BTZOE30072NBCM	1,330	3" black locking casters	standard metal
	33	36 x 72	2	BTZOE36072NBCM	1,390	3" black locking casters	standard metal
	15	20 x 60	2	BTZOE20060NBPME	1,290	3" premium locking casters	standard metal
	21	24 x 60	2	BTZOE24060NBPME	1,320	3" premium locking casters	standard metal
	27	30 x 60	2	BTZOE30060NBPME	1,340	3" premium locking casters	standard metal
	33	36 x 60	2	BTZOE36060NBPME	1,390	3" premium locking casters	standard metal
	15	20 x 72	2	BTZOE20072NBPME	1,330	3" premium locking casters	standard metal
	21	24 x 72	2	BTZOE24072NBPME	1,350	3" premium locking casters	standard metal
	27	30 x 72	2	BTZOE30072NBPME	1,380	3" premium locking casters	standard metal
	33	36 x 72	2	BTZOE36072NBPME	1,430	3" premium locking casters	standard metal
without beam	15	20 x 72	2	BTZOE20072NEGME	1,130	adj glides	standard metal
	21	24 x 60	2	BTZOE24072NEGME	1,170	adj glides	standard metal
	27	30 x 72	2	BTZOE30072NEGME	1,220	adj glides	standard metal
	15	20 x 72	2	BTZOE20072NECME	1,130	3" black locking casters	standard metal
	21	24 x 60	2	BTZOE24072NECME	1,170	3" black locking casters	standard metal
	27	30 x 72	2	BTZOE30072NECME	1,220	3" black locking casters	standard metal
without beam	15	20 x 72	2	BTZOE20072NEPME	1,180	3" premium locking casters	standard metal
	21	24 x 60	2	BTZOE24072NEPME	1,210	3" premium locking casters	standard metal
	27	30 x 72	2	BTZOE30072NEPME	1,270	3" premium locking casters	standard metal



**C casters**  
3" black dual wheel locking



**P premium casters**  
3" white dual wheel locking

**Standard metal powder coat finishes (ME):**  
Black Wrinkle, Chateau Brown Wrinkle, Flat Black, Furniture White, Inner Tone, Light Tone, Medium Tone, and Metallic Silver

#### Zoey flip nest bases with a beam do not require top stiffeners

The cost of the top stiffener is included in the standard Symphony top price.  
Deduct the following from the list price shown for a top in the top section of the price list  
-\$40 list for tops that are up to 24" deep (1 stiffener)  
-\$80 list for tops that are up to 36" deep (2 stiffeners)

ADDITIONAL FLIP NEST BEAM LENGTHS AVAILABLE FOR TOPS UP TO 96" LONG, EMAIL SERVICE@SYMPHONYTABLES.COM FOR MORE INFORMATION.

Note that the "NE" model numbers do not have a beam and therefore the bases cannot be spread more than 50" apart at center when using top stiffeners.

# bases

## T nesting sets

### Moto 2

base	base dim.	max top support	base set qty	base set model no.	list	glide/caster	finish
Moto 2 (2" column) with beam	18	24 x 60	2	BTMO224060NBGM	1,380	adj glides	standard metal
	22	30 x 60	2	BTMO230060NBGM	1,390	adj glides	standard metal
	26	36 x 60	2	BTMO236060NBGM	1,450	adj glides	standard metal
	18	24 x 72	2	BTMO224072NBGM	1,420	adj glides	standard metal
	22	30 x 72	2	BTMO230072NBGM	1,430	adj glides	standard metal
	26	36 x 72	2	BTMO236072NBGM	1,490	adj glides	standard metal
without beam	18	24 x 60	2	BTMO224060NBCM	1,460	2" black locking casters	standard metal
	22	30 x 60	2	BTMO230060NBCM	1,470	2" black locking casters	standard metal
	26	36 x 60	2	BTMO236060NBCM	1,540	2" black locking casters	standard metal
	18	24 x 72	2	BTMO224072NBCM	1,510	2" black locking casters	standard metal
	22	30 x 72	2	BTMO230072NBCM	1,520	2" black locking casters	standard metal
	26	36 x 72	2	BTMO236072NBCM	1,570	2" black locking casters	standard metal
	18	24 x 60	2	BTMO224060NBPME	1,510	2" premium locking casters	standard metal
	22	30 x 60	2	BTMO230060NBPME	1,520	2" premium locking casters	standard metal
	26	36 x 60	2	BTMO236060NBPME	1,580	2" premium locking casters	standard metal
	18	24 x 72	2	BTMO224072NBPME	1,550	2" premium locking casters	standard metal
	22	30 x 72	2	BTMO230072NBPME	1,560	2" premium locking casters	standard metal
	26	36 x 72	2	BTMO236072NBPME	1,620	2" premium locking casters	standard metal
without beam	18	24 x 72	2	BTMO224072NEGME	1,210	adj glides	standard metal
	22	30 x 72	2	BTMO230072NEGME	1,230	adj glides	standard metal
	18	24 x 72	2	BTMO224072NECME	1,300	2" black locking casters	standard metal
	22	30 x 72	2	BTMO230072NECME	1,320	2" black locking casters	standard metal
	18	24 x 72	2	BTMO224072NEPME	1,340	2" premium locking casters	standard metal
	22	30 x 72	2	BTMO230072NEPME	1,360	2" premium locking casters	standard metal



**C casters**  
2" black dual wheel locking



**P premium casters**  
2" silver/black dual wheel locking

**Standard metal powder coat finishes (ME):**  
Black Wrinkle, Chateau Brown Wrinkle, Flat Black, Furniture White, Inner Tone, Light Tone, Medium Tone, and Metallic Silver

#### Moto flip nest bases with a beam do not require top stiffeners

The cost of the top stiffener is included in the standard Symphony top price.  
Deduct the following from the list price shown for a top in the top section of the price list  
-\$40 list for tops that are up to 24" deep (1 stiffener)  
-\$80 list for tops that are up to 36" deep (2 stiffeners)

ADDITIONAL FLIP NEST BEAM LENGTHS AVAILABLE FOR TOPS UP TO 96" LONG, EMAIL SERVICE@SYMPHONYTABLES.COM FOR MORE INFORMATION.

Note that the "NE" model numbers do not have a beam and therefore the bases cannot be spread more than 50" apart at center when using top stiffeners.

# bases

T nesting adjustable height sets

Keller, Ria, Rosanno, Novi

	base	base dim.	max top support	base set qty	base set model no.	list	glides or casters	finish
Keller	nesting/spring clip	15	20 x 72	2	BTKEL20072NSGME	1,580	adj glides	standard metal
		20	24 x 72	2	BTKEL24072NSGME	1,620	adj glides	standard metal
		26	36 x 72	2	BTKEL36072NSGME	1,680	adj glides	standard metal
	nesting/spring clip	15	20 x 72	2	BTKEL20072NSCME	1,670	2" black locking casters	standard metal
		20	24 x 72	2	BTKEL24072NSCME	1,710	2" black locking casters	standard metal
		26	36 x 72	2	BTKEL36072NSCME	1,770	2" black locking casters	standard metal
Ria	nesting/spring clip	15	20 x 72	2	BTRIA20072NSGME	1,490	adj glides	standard metal
		20	24 x 72	2	BTRIA24072NSGME	1,510	adj glides	standard metal
		26	36 x 72	2	BTRIA36072NSGME	1,550	adj glides	standard metal
	nesting/spring clip	15	20 x 72	2	BTRIA20072NSCME	1,570	2" black locking casters	standard metal
		20	24 x 72	2	BTRIA24072NSCME	1,600	2" black locking casters	standard metal
		26	36 x 72	2	BTRIA36072NSCME	1,640	2" black locking casters	standard metal
Rosanno	nesting/spring clip	18	20 x 72	2	BTROS20072NSGME	1,520	adj glides	standard metal
		22	30 x 72	2	BTROS30072NSGME	1,540	adj glides	standard metal
		26	36 x 72	2	BTROS36072NSGME	1,600	adj glides	standard metal
	nesting/spring clip	18	20 x 72	2	BTROS20072NSCME	1,610	2" black locking casters	standard metal
		22	30 x 72	2	BTROS30072NSCME	1,630	2" black locking casters	standard metal
		26	36 x 72	2	BTROS36072NSCME	1,680	2" black locking casters	standard metal
Novi	nesting/spring clip	18	20 x 72	2	BTNOV20072NSGME	1,450	adj glides	standard metal
		22	30 x 72	2	BTNOV30072NSGME	1,460	adj glides	standard metal
		26	36 x 72	2	BTNOV36072NSGME	1,500	adj glides	standard metal
	nesting/spring clip	18	20 x 72	2	BTNOV20072NSCME	1,540	2" black locking casters	standard metal
		22	30 x 72	2	BTNOV30072NSCME	1,550	2" black locking casters	standard metal
		26	36 x 72	2	BTNOV36072NSCME	1,580	2" black locking casters	standard metal
	nesting/spring clip	18	20 x 72	2	BTNOV20072NSHME	1,560	glides/concealed casters	standard metal
		22	30 x 72	2	BTNOV30072NSHME	1,570	glides/concealed casters	standard metal
		26	36 x 72	2	BTNOV36072NSHME	1,610	glides/concealed casters	standard metal



**C casters**  
2" black dual wheel locking



**H Novi hidden/concealed casters**  
one T base per set has glides, the other base has hidden/concealed casters

**Standard metal powder coat finishes (ME)**

Black Wrinkle, Chateau Brown Wrinkle, Flat Black, Furniture White, Inner Tone, Light Tone, Medium Tone, and Metallic Silver



**S Spring clip height adjustment**  
24.75" - 33.75" (Keller, Ria, Rosanno and Novi)  
range in 1" increments

**KELLER, RIA, ROSANNO AND NOVI  
SINGLE T FLIP MECH IMAGE:**



Note that the bases cannot be spread more than 50" apart at center.

# bases

T adjustable height sets

Keller, Ria, Rosanno, Novi

	base	base dim.	max top support	base set qty	base set model no.	list	glides or casters	finish
Keller	spring clip	15	20 x 72	2	BTKEL20072SSGME	1,080	adj glides	standard metal
		20	24 x 72	2	BTKEL24072SSGME	1,100	adj glides	standard metal
		26	36 x 72	2	BTKEL36072SSGME	1,180	adj glides	standard metal
	spring clip	33	42 x 72	2	BTKEL42072SSGME	1,310	adj glides	standard metal
		15	20 x 72	2	BTKEL20072SSCME	1,170	2" black locking casters	standard metal
		20	24 x 72	2	BTKEL24072SSCME	1,190	2" black locking casters	standard metal
Ria	spring clip	26	36 x 72	2	BTKEL36072SSCME	1,270	2" black locking casters	standard metal
		33	42 x 72	2	BTKEL42072SSCME	1,400	2" black locking casters	standard metal
		15	20 x 72	2	BTRIA20072SSGME	990	adj glides	standard metal
	spring clip	20	24 x 72	2	BTRIA24072SSGME	1,000	adj glides	standard metal
		26	36 x 72	2	BTRIA36072SSGME	1,070	adj glides	standard metal
		33	42 x 72	2	BTRIA42072SSGME	1,210	adj glides	standard metal
Rosanno	spring clip	15	20 x 72	2	BTRIA20072SSCME	1,080	2" black locking casters	standard metal
		20	24 x 72	2	BTRIA24072SSCME	1,090	2" black locking casters	standard metal
		26	36 x 72	2	BTRIA36072SSCME	1,160	2" black locking casters	standard metal
	spring clip	33	42 x 72	2	BTRIA42072SSCME	1,300	2" black locking casters	standard metal
		16	20 x 72	2	BTROS20072SSGME	980	adj glides	standard metal
		22	30 x 72	2	BTROS30072SSGME	990	adj glides	standard metal
Novi	spring clip	26	36 x 72	2	BTROS36072SSGME	1,170	adj glides	standard metal
		16	20 x 72	2	BTROS20072SSCME	1,070	2" black locking casters	standard metal
		22	30 x 72	2	BTROS30072SSCME	1,080	2" black locking casters	standard metal
	spring clip	26	36 x 72	2	BTROS36072SSCME	1,250	2" black locking casters	standard metal
		18	20 x 72	2	BTNOV20072SSGME	960	adj glides	standard metal
		22	30 x 72	2	BTNOV30072SSGME	990	adj glides	standard metal
Novi	spring clip	26	36 x 72	2	BTNOV36072SSGME	1,010	adj glides	standard metal
		32	42 x 72	2	BTNOV42072SSGME	1,200	adj glides	standard metal
		18	20 x 72	2	BTNOV20072SSCME	1,050	2" black locking casters	standard metal
		22	30 x 72	2	BTNOV30072SSCME	1,080	2" black locking casters	standard metal
		26	36 x 72	2	BTNOV36072SSCME	1,100	2" black locking casters	standard metal
		32	42 x 72	2	BTNOV42072SSCME	1,290	2" black locking casters	standard metal
	ratchet	18	20 x 72	2	BTNOV20072SSHME	1,070	glides/concealed casters	standard metal
		22	30 x 72	2	BTNOV30072SSHME	1,100	glides/concealed casters	standard metal
		26	36 x 72	2	BTNOV36072SSHME	1,120	glides/concealed casters	standard metal
		32	42 x 72	2	BTNOV42072SSHME	1,310	glides/concealed casters	standard metal
		18	24 x 72	2	BTNOV24072SRGME	1,490	adj glides	standard metal
		22	30 x 72	2	BTNOV30072SRGME	1,510	adj glides	standard metal
Novi	spring clip	26	36 x 72	2	BTNOV36072SRGME	1,530	adj glides	standard metal
		18	24 x 72	2	BTNOV24072SRCME	1,570	2" black locking casters	standard metal
		22	30 x 72	2	BTNOV30072SRCME	1,600	2" black locking casters	standard metal
	spring clip	26	36 x 72	2	BTNOV36072SRCME	1,620	2" black locking casters	standard metal
		18	24 x 72	2	BTNOV24072SRHME	1,600	glides/concealed casters	standard metal
		22	30 x 72	2	BTNOV30072SRHME	1,620	glides/concealed casters	standard metal
26	36 x 72	2	BTNOV36072SRHME	1,640	glides/concealed casters	standard metal		



**C casters**  
2" black dual wheel locking



**H Novi hidden/concealed casters**  
one T base per set has glides, the other base has hidden/concealed casters



**S Spring clip height adjustment**  
24.75" - 33.75" (Keller, Ria, Rosanno, and Novi)  
range in 1" increments

**R Ratchet height adjustment (Novi)**  
can be combined with flip top and casters  
27.75" - 39.75" height range  
easy adjustment: set foot on base and lift surface to lower, lift to highest level for release down to lowest position



**Standard metal powder coat finishes (ME)**

Black Wrinkle, Chateau Brown Wrinkle, Flat Black, Furniture White, Inner Tone, Light Tone, Medium Tone, and Metallic Silver

# bases

## T adjustable height sets

### Zoey, Moto

base	base dim.	max top support	base set qty	base set model no.	list	glides or casters	finish	
<b>Zoey</b>								
	spring clip	15	20 x 72	2	BTZOE20072SPGME	1,070	adj glides	standard metal
		21	24 x 72	2	BTZOE24072SPGME	1,090	adj glides	standard metal
		27	36 x 72	2	BTZOE36072SPGME	1,160	adj glides	standard metal
		33	42 x 72	2	BTZOE42072SPGME	1,190	adj glides	standard metal
		15	20 x 72	2	BTZOE20072SPCME	1,160	3" black locking casters	standard metal
		21	24 x 72	2	BTZOE24072SPCME	1,180	3" black locking casters	standard metal
		27	36 x 72	2	BTZOE36072SPCME	1,240	3" black locking casters	standard metal
		33	42 x 72	2	BTZOE42072SPCME	1,280	3" black locking casters	standard metal
		15	20 x 72	2	BTZOE20072SPPME	1,200	3" premium locking casters	standard metal
		21	24 x 72	2	BTZOE24072SPPME	1,220	3" premium locking casters	standard metal
		27	36 x 72	2	BTZOE36072SPPME	1,290	3" premium locking casters	standard metal
		33	42 x 72	2	BTZOE42072SPPME	1,320	3" premium locking casters	standard metal
<b>Moto (3" column)</b>								
	ratchet	18	24 x 72	2	BTMOT24072SRGME	1,170	adj glides	standard metal
		22	30 x 72	2	BTMOT30072SRGME	1,190	adj glides	standard metal
		26	36 x 72	2	BTMOT36072SRGME	1,230	adj glides	standard metal
		18	24 x 72	2	BTMOT24072SRCME	1,250	2" black locking casters	standard metal
		22	30 x 72	2	BTMOT30072SRCME	1,280	2" black locking casters	standard metal
		26	36 x 72	2	BTMOT36072SRCME	1,320	2" black locking casters	standard metal
		18	24 x 72	2	BTMOT24072SRPME	1,300	2" premium locking casters	standard metal
		22	30 x 72	2	BTMOT30072SRPME	1,320	2" premium locking casters	standard metal
		26	36 x 72	2	BTMOT36072SRPME	1,360	2" premium locking casters	standard metal
		18	24 x 72	2	BTMOT24072SCGME	1,530	adj glides	standard metal
		22	30 x 72	2	BTMOT30072SCGME	1,540	adj glides	standard metal
		26	36 x 72	2	BTMOT36072SCGME	1,600	adj glides	standard metal
	18	24 x 72	2	BTMOT24072SCCME	1,620	2" black locking casters	standard metal	
	22	30 x 72	2	BTMOT30072SCCME	1,630	2" black locking casters	standard metal	
	26	36 x 72	2	BTMOT36072SCCME	1,680	2" black locking casters	standard metal	
	18	24 x 72	2	BTMOT24072SCPME	1,660	2" premium locking casters	standard metal	
	22	30 x 72	2	BTMOT30072SCPME	1,670	2" premium locking casters	standard metal	
	26	36 x 72	2	BTMOT36072SCPME	1,730	2" premium locking casters	standard metal	
	18	24 x 72	2	BTMOT24072SEGME	2,610	adj glides	standard metal	
	22	30 x 72	2	BTMOT30072SEGME	2,620	adj glides	standard metal	
	26	36 x 72	2	BTMOT36072SEGME	2,660	adj glides	standard metal	
	18	24 x 72	2	BTMOT24072SPGME	2,760	adj glides	standard metal	
	22	30 x 72	2	BTMOT30072SPGME	2,770	adj glides	standard metal	
	26	36 x 72	2	BTMOT36072SPGME	2,820	adj glides	standard metal	

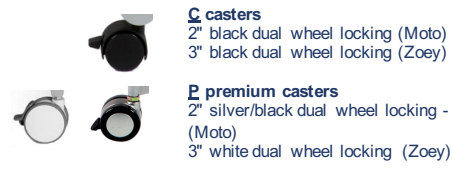

**Standard metal powder coat finishes (ME)**  
Flat Black, Furniture White, Inner Tone, Light Tone, Medium Tone, and Metallic Silver

\*\* Note that the inner column of Moto height adjustable bases are only available in Flat Black, White or Metallic Silver. Note that Moto White is a shade off and a little creamier than Furniture White. The Moto Counter balance and Ratchet height adjustable bases inner and outer columns are only available in Flat Black, Moto White and Metallic Silver.

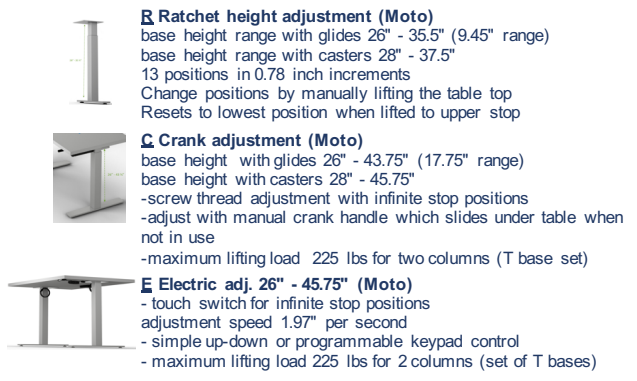

Contact service@symphonytables.com for complete ordering instructions. Height adjustable bases require a higher level of product understanding and installation.

# bases

## T adjustable height sets

### Moto

base	base dim.	max top support	base set qty	base set model no.	list	glides or casters	finish	
<b>Moto (3" column)</b>								
	pneumatic counter balance	18	24 x 42	2	BTMOT24042SNGME	2,710	adj glides	standard metal
		18	24 x 54	2	BTMOT24054SNGME	2,730	adj glides	standard metal
		18	24 x 60	2	BTMOT24060SNGME	2,740	adj glides	standard metal
		18	24 x 66	2	BTMOT24066SNGME	2,770	adj glides	standard metal
		18	24 x 72	2	BTMOT24072SNGME	2,790	adj glides	standard metal
		18	24 x 42	2	BTMOT24042SNCME	2,790	2" black locking casters	standard metal
		18	24 x 54	2	BTMOT24054SNCME	2,820	2" black locking casters	standard metal
		18	24 x 60	2	BTMOT24060SNCME	2,830	2" black locking casters	standard metal
		18	24 x 66	2	BTMOT24066SNCME	2,860	2" black locking casters	standard metal
		18	24 x 72	2	BTMOT24072SNCME	2,880	2" black locking casters	standard metal
		18	24 x 42	2	BTMOT24042SNPME	2,840	2" premium locking casters	standard metal
		18	24 x 54	2	BTMOT24054SNPME	2,860	2" premium locking casters	standard metal
		18	24 x 60	2	BTMOT24060SNPME	2,870	2" premium locking casters	standard metal
		18	24 x 66	2	BTMOT24066SNPME	2,900	2" premium locking casters	standard metal
		18	24 x 72	2	BTMOT24072SNPME	2,930	2" premium locking casters	standard metal
		22	30 x 42	2	BTMOT30042SNGME	2,730	adj glides	standard metal
		22	30 x 54	2	BTMOT30042SNGME	2,760	adj glides	standard metal
		22	30 x 60	2	BTMOT30042SNGME	2,770	adj glides	standard metal
		22	30 x 66	2	BTMOT30042SNGME	2,790	adj glides	standard metal
		22	30 x 72	2	BTMOT30042SNGME	2,810	adj glides	standard metal
		22	30 x 42	2	BTMOT30042SNCME	2,820	2" black locking casters	standard metal
		22	30 x 54	2	BTMOT30042SNCME	2,850	2" black locking casters	standard metal
		22	30 x 60	2	BTMOT30042SNCME	2,860	2" black locking casters	standard metal
		22	30 x 66	2	BTMOT30042SNCME	2,880	2" black locking casters	standard metal
	22	30 x 72	2	BTMOT30042SNCME	2,890	2" black locking casters	standard metal	
	22	30 x 42	2	BTMOT30042SNPME	2,860	2" premium locking casters	standard metal	
	22	30 x 54	2	BTMOT30042SNPME	2,890	2" premium locking casters	standard metal	
	22	30 x 60	2	BTMOT30042SNPME	2,900	2" premium locking casters	standard metal	
	22	30 x 66	2	BTMOT30042SNPME	2,930	2" premium locking casters	standard metal	
	22	30 x 72	2	BTMOT30042SNPME	2,940	2" premium locking casters	standard metal	
	26	36 x 42	2	BTMOT36042SNGME	2,790	adj glides	standard metal	
	26	36 x 54	2	BTMOT36054SNGME	2,810	adj glides	standard metal	
	26	36 x 60	2	BTMOT36060SNGME	2,830	adj glides	standard metal	
	26	36 x 66	2	BTMOT36066SNGME	2,840	adj glides	standard metal	
	26	36 x 72	2	BTMOT36072SNGME	2,860	adj glides	standard metal	
	26	36 x 42	2	BTMOT36042SNCME	2,880	2" black locking casters	standard metal	
	26	36 x 54	2	BTMOT36054SNCME	2,890	2" black locking casters	standard metal	
	26	36 x 60	2	BTMOT36060SNCME	2,920	2" black locking casters	standard metal	
	26	36 x 66	2	BTMOT36066SNCME	2,930	2" black locking casters	standard metal	
	26	36 x 72	2	BTMOT36072SNCME	2,950	2" black locking casters	standard metal	
	26	36 x 42	2	BTMOT36042SNPME	2,930	2" premium locking casters	standard metal	
	26	36 x 54	2	BTMOT36054SNPME	2,940	2" premium locking casters	standard metal	
	26	36 x 60	2	BTMOT36060SNPME	2,960	2" premium locking casters	standard metal	
	26	36 x 66	2	BTMOT36066SNPME	2,970	2" premium locking casters	standard metal	
	26	36 x 72	2	BTMOT36072SNPME	2,990	2" premium locking casters	standard metal	



**P Pneumatic counter balance (Moto)**  
base height range with glides 26" - 45.5" (19.5" range)  
base height range with casters 28" - 47.5"  
-Frame widths will accommodate tops from 42" - 72" long and 24" - 36" deep. We cannot modify the frame to fit tops that are any other size due to the components used to make the pneumatic counter balance adjustable bases.  
-Must specify the weight of the top and all accessories that will be used on the bases so that the lift capacity can be set properly.

Contact service@symphonytables.com for complete ordering instructions. Height adjustable bases require a higher level of product understanding and installation.



# bases

## T adjustable height sets

### Kenna

base	base dim.	max top support	base set qty	base set model no.	list	glides or casters	finish
<b>Kenna T base sets</b>							
<b>Single Stage Electric</b>							
basic up/down switch	22	24 x 48-72	2	BTKEN24072SEGME	1,320	adj glides	standard metal
	28	30 x 48-72	2	BTKEN30072SEGME	1,330	adj glides	standard metal
programmable switch	22	24 x 48-72	2	BTKEN24072SPGME	1,440	adj glides	standard metal
	28	30 x 48-72	2	BTKEN30072SPGME	1,460	adj glides	standard metal
*tables over 60"L require the Kenna horizontal wire manager							
<b>Dual Stage Electric</b>							
basic up/down switch	22	24 x 48-72	2	BTKEN24072DEGME	1,580	adj glides	standard metal
	28	30 x 48-72	2	BTKEN30072DEGME	1,610	adj glides	standard metal
programmable switch	22	24 x 48-72	2	BTKEN24072DPGME	1,730	adj glides	standard metal
	28	30 x 48-72	2	BTKEN30072DPGME	1,740	adj glides	standard metal
*tables over 60"L require the Kenna horizontal wire manager							
<b>Kenna 90 degree 3 column: (2) T, (1) post base set</b>							
basic up/down switch	22	24 x 48-72	2	BTKE324072SEGME	2,180	adj glides	standard metal
	28	30 x 48-72	2	BTKE330072SEGME	2,190	adj glides	standard metal
programmable switch	22	24 x 48-72	2	BTKE324072SPGME	2,320	adj glides	standard metal
	28	30 x 48-72	2	BTKE330072SPGME	2,330	adj glides	standard metal
* top not included *tables over 60"L require the Kenna horizontal wire manager							
<b>Kenna 120 degree 3 column: (2) T, (1) post base set</b>							
basic up/down switch	22	24 x 48-60	2	BTKE124060SEGME	2,180	adj glides	standard metal
	28	30 x 48-60	2	BTKE130060SEGME	2,320	adj glides	standard metal
programmable switch	22	24 x 48-60	2	BTKE124060SPGME	2,260	adj glides	standard metal
	28	30 x 48-60	2	BTKE130060SPGME	2,330	adj glides	standard metal
* top not included							

- SEG** Single Stage Electric adj. 27" - 46" (Kenna)
- DEG** Dual Stage Electric adj. 24" - 48" (Kenna)
  - basic up / down switch / undersurface mount
  - adjustment speed 1.375" per second
- SPG** Single Stage Electric adj. 27" - 46" (Kenna)
- DPG** Dual Stage Electric adj. 24" - 48" (Kenna)
  - programmable keypad / under surface mount
  - 4 preset programmable heights
  - shelf stop and container stop feature that will stop raising or lowering the worksurface if there are items above or below the worksurface that could impact the table
  - digital display
  - adjustment speed 1.375" per second

**Kenna horizontal wire manager** connects between the two table legs under the table top, manages wires and supports the worksurface  
 \*for 2 column versions only - not available for 3 column units, only available in a black finish  
 48"-66" tops use model # **OTWMHAT4866 \$80 list**  
 66"-72" tops use model # **OTWMHAT6672 \$110 list**  
 \*required on tables over 60"

**Kenna 23.5" vertical column wire manager**  
 -bolts into the independent beam and slides around the upper column  
 -allows wires to hang loose so the table can still go up and down while organizing them  
 -can be painted to match base color  
 model # **OBTWWMKEN23 \$70 list**

**Kenna weight capacity:**  
 - maximum lifting load 200 lbs. for (2) T bases  
 - maximum lifting load 250 lbs 3 column configurations with (2) T bases + (1) post base

**Kenna Standard metal powder coat finishes (ME)**  
 Flat Black, Furniture White, Inner Tone, Light Tone, Medium Tone, and Metallic Silver

# bases

## T adjustable height sets

### Matt

base	base dim.	max top support	base set qty	base set model no.	list	glides	finish
<b>Matt II Electric height adjustable T Single Stage Electric</b>							
basic up/down switch	23	24 x 48-72	2	BTMA224072SEGF	1,170	adj glides	flat black
	23	24 x 48-72	2	BTMA224072SEGF	1,170	adj glides	furniture white
	23	24 x 48-72	2	BTMA224072SEGM	1,170	adj glides	metallic silver
	28	30 x 48-72	2	BTMA230072SEGF	1,210	adj glides	flat black
	28	30 x 48-72	2	BTMA230072SEGF	1,210	adj glides	furniture white
	28	30 x 48-72	2	BTMA230072SEGM	1,210	adj glides	metallic silver
programmable switch	23	24 x 48-72	2	BTMA224072SPGF	1,250	adj glides	flat black
	23	24 x 48-72	2	BTMA224072SPGF	1,250	adj glides	furniture white
	23	24 x 48-72	2	BTMA224072SPGM	1,250	adj glides	metallic silver
	28	30 x 48-72	2	BTMA230072SPGF	1,290	adj glides	flat black
	28	30 x 48-72	2	BTMA230072SPGF	1,290	adj glides	furniture white
	28	30 x 48-72	2	BTMA230072SPGM	1,290	adj glides	metallic silver
basic up/down switch w/ sensor control	23	24 x 48-72	2	BTMA324072SEGF	1,230	adj glides	flat black
	23	24 x 48-72	2	BTMA324072SEGF	1,230	adj glides	furniture white
	23	24 x 48-72	2	BTMA324072SEGM	1,230	adj glides	metallic silver
	28	30 x 48-72	2	BTMA330072SEGF	1,270	adj glides	flat black
	28	30 x 48-72	2	BTMA330072SEGF	1,270	adj glides	furniture white
	28	30 x 48-72	2	BTMA330072SEGM	1,270	adj glides	metallic silver
programmable switch w/ sensor control	23	24 x 48-72	2	BTMA324072SPGF	1,310	adj glides	flat black
	23	24 x 48-72	2	BTMA324072SPGF	1,310	adj glides	furniture white
	23	24 x 48-72	2	BTMA324072SPGM	1,310	adj glides	metallic silver
	28	30 x 48-72	2	BTMA330072SPGF	1,340	adj glides	flat black
	28	30 x 48-72	2	BTMA330072SPGF	1,340	adj glides	furniture white
	28	30 x 48-72	2	BTMA330072SPGM	1,340	adj glides	metallic silver
<b>Dual Stage Electric</b>							
basic up/down switch	23	24 x 48-72	2	BTMA224072DEGF	1,360	adj glides	flat black
	23	24 x 48-72	2	BTMA224072DEGF	1,360	adj glides	furniture white
	23	24 x 48-72	2	BTMA224072DEGM	1,360	adj glides	metallic silver
	28	30 x 48-72	2	BTMA230072DEGF	1,400	adj glides	flat black
	28	30 x 48-72	2	BTMA230072DEGF	1,400	adj glides	furniture white
	28	30 x 48-72	2	BTMA230072DEGM	1,400	adj glides	metallic silver
programmable switch	23	24 x 48-72	2	BTMA224072DPGF	1,450	adj glides	flat black
	23	24 x 48-72	2	BTMA224072DPGF	1,450	adj glides	furniture white
	23	24 x 48-72	2	BTMA224072DPGM	1,450	adj glides	metallic silver
	28	30 x 48-72	2	BTMA230072DPGF	1,480	adj glides	flat black
	28	30 x 48-72	2	BTMA230072DPGF	1,480	adj glides	furniture white
	28	30 x 48-72	2	BTMA230072DPGM	1,480	adj glides	metallic silver
basic up/down switch w/ sensor control	23	24 x 48-72	2	BTMA324072DEGF	1,420	adj glides	flat black
	23	24 x 48-72	2	BTMA324072DEGF	1,420	adj glides	furniture white
	23	24 x 48-72	2	BTMA324072DEGM	1,420	adj glides	metallic silver
	28	30 x 48-72	2	BTMA330072DEGF	1,460	adj glides	flat black
	28	30 x 48-72	2	BTMA330072DEGF	1,460	adj glides	furniture white
	28	30 x 48-72	2	BTMA330072DEGM	1,460	adj glides	metallic silver
programmable switch w/ sensor control	23	24 x 48-72	2	BTMA324072DPGF	1,500	adj glides	flat black
	23	24 x 48-72	2	BTMA324072DPGF	1,500	adj glides	furniture white
	23	24 x 48-72	2	BTMA324072DPGM	1,500	adj glides	metallic silver
	28	30 x 48-72	2	BTMA330072DPGF	1,540	adj glides	flat black
	28	30 x 48-72	2	BTMA330072DPGF	1,540	adj glides	furniture white
	28	30 x 48-72	2	BTMA330072DPGM	1,540	adj glides	metallic silver

- SEG** Single Stage Electric adj. 26" - 45"
- DEG** Dual Stage Electric adj. 21.75" - 47.75"
  - basic up / down switch / undersurface mount
  - adjustment speed 1.375" per second
- SPG** Single Stage Electric adj. 26" - 45"
- DPG** Dual Stage Electric adj. 21.75" - 47.75"
  - programmable keypad / under surface mount
  - 4 preset programmable heights
  - digital display
  - adjustment speed 1.375" per second

**Matt II Standard metal finish options**  
**FB** Flat Black  
**FW** Furniture White  
**MS** Metallic Silver  
**Sensor control**  
 Sensor - collision mitigation option significantly increases the safety of the height adjustable table. It detects collision when the table is moved and can significantly reduce damage to the table and the colliding object.

**Matt II weight capacity:**  
 - maximum lifting load 250 lbs. for (2) T bases (including the top)

# bases

## T adjustable height sets

### Nina

base	base dim.	max top support	base set qty	base set model no.	list	glides or casters	finish
Nina T base sets							
							
Single Stage Electric							
basic up/down switch	23 29	24 x 48-72 30 x 48-72	2 2	BTNI24072SEGME BTNI30072SEGME	1,890 1,900	adj glides adj glides	standard metal standard metal
programmable switch	23 29	24 x 48-72 30 x 48-72	2 2	BTNI24072SPGME BTNI30072SPGME	2,060 2,070	adj glides adj glides	standard metal standard metal
Dual Stage Electric							
basic up/down switch	23 29	24 x 48-72 30 x 48-72	2 2	BTNI24072DEGME BTNI30072DEGME	2,170 2,180	adj glides adj glides	standard metal standard metal
programmable switch	23 29	24 x 48-72 30 x 48-72	2 2	BTNI24072DPGME BTNI24072DPGME	2,330 2,340	adj glides adj glides	standard metal standard metal

\* top not included

Nina 90 degree 3 column: (2) T, (1) post base set

							
basic up/down switch	23 29	24 x 48-72 30 x 48-72	2 2	BTNI324072SEGME BTNI324072SEGME	2,790 2,810	adj glides adj glides	standard metal standard metal
programmable switch	23 29	24 x 48-72 30 x 48-72	2 2	BTNI324072SPGME BTNI324072SPGME	2,930 2,950	adj glides adj glides	standard metal standard metal

\* top not included

Nina 120 degree 3 column: (2) T, (1) post base set

							
basic up/down switch	23 29	24 x 48-72 30 x 48-72	2 2	BTNI124072SEGME BTNI124072SEGME	2,790 2,810	adj glides adj glides	standard metal standard metal
programmable switch	23 29	24 x 48-72 30 x 48-72	2 2	BTNI124072SPGME BTNI124072SPGME	2,930 2,950	adj glides adj glides	standard metal standard metal

\* top not included

 **SEG** Single Stage Electric adj. 26" - 45" (Nina)  
**DEG** Dual Stage Electric adj. 21" - 49" (Nina)  
 - simple up-down keypad control / under surface mount  
 - adjustment speed 1.5" per second

 **SPG** Single Stage Electric adj. 26" - 45" (Nina)  
**DPG** Dual Stage Electric adj. 21" - 49" (Nina)  
 - programmable keypad / under surface mount  
 - 4 preset programmable heights  
 - shelf stop and container stop feature that will stop raising or lowering the worksurface if there are items above or below the worksurface that could impact the table  
 - digital display  
 - adjustment speed 1.5" per second

#### Standard metal powder coat finishes (ME)

Flat Black, Furniture White, Inner Tone, Light Tone, Medium Tone, and Metallic Silver

 Magnetic wire manager for a square or rectangular column standard dimensions: 17 3/4" length, 2" width, 1.06" depth large area for wire management of multiple power and cord sizes easy installation and reposition to any metal surface  
 \*\* specify metal finish

#### Model # OBWMMM18 \$100 list

**Nina Electric height adjustable weight capacity:**  
 - maximum lifting load 225 lbs. for (2) T bases or 250 lbs for 3 column configurations with (2) T bases + (1) post base

# bases

## T adjustable height sets

### Nina

base	base dim.	max top support	base set qty	base set model no.	list	glides or casters	finish
Nina Fast Crank							
							
	23	24 x 36	2	BTNI24036SCGME	2,400	adj glides	standard metal
	23	24 x 42	2	BTNI24042SCGME	2,410	adj glides	standard metal
	23	24 x 48	2	BTNI24048SCGME	2,420	adj glides	standard metal
	23	24 x 54	2	BTNI24054SCGME	2,430	adj glides	standard metal
	23	24 x 60	2	BTNI24060SCGME	2,440	adj glides	standard metal
	23	24 x 66	2	BTNI24066SCGME	2,460	adj glides	standard metal
	23	24 x 72	2	BTNI24072SCGME	2,480	adj glides	standard metal
	29	30 x 36	2	BTNI30036SCGME	2,420	adj glides	standard metal
	29	30 x 42	2	BTNI30042SCGME	2,430	adj glides	standard metal
	29	30 x 48	2	BTNI30048SCGME	2,440	adj glides	standard metal
	29	30 x 54	2	BTNI30054SCGME	2,460	adj glides	standard metal
	29	30 x 60	2	BTNI30060SCGME	2,480	adj glides	standard metal
	29	30 x 66	2	BTNI30066SCGME	2,490	adj glides	standard metal
	29	30 x 72	2	BTNI30072SCGME	2,500	adj glides	standard metal

#### Standard metal powder coat finishes (ME)

Flat Black, Furniture White, Inner Tone, Light Tone, Medium Tone, and Metallic Silver



#### Nina Fast Crank

- 28.5 - 47" height range
- adjustment speed 1.125" per 1 revolution
- 18.3" stroke length
- maximum lifting load 100 lbs. (including top)
- crank handle slides inward to store underneath table top when not in use
- available as a single stage, two-column base only





**Magnetic wire manager** for a square or rectangular column standard dimensions: 17 3/4" length, 2" width, 1.06" depth large area for wire management of multiple power and cord sizes easy installation and reposition to any metal surface  
 \*\* specify metal finish

#### Model # OBWMMM18 - \$100 list

# bases

## C fixed single column sets

Keller, Ria, Novi

base	base dim.	max top support	base set qty	base set model no.	list	glides or casters	finish
	15	20 x 96	2	BCKEL20096SDGME	750	adj glides	standard metal
	22	24 x 96	2	BCKEL24096SDGME	770	adj glides	standard metal
	27	30 x 96	2	BCKEL30096SDGME	850	adj glides	standard metal
	15	20 x 96	2	BCKEL20096SDCME	840	2" black locking casters	standard metal
	22	24 x 96	2	BCKEL24096SDCME	860	2" black locking casters	standard metal
	27	30 x 96	2	BCKEL30096SDCME	940	2" black locking casters	standard metal
	15	20 x 96	2	BCKEL20096SDGPO	880	adj glides	polished
	22	24 x 96	2	BCKEL24096SDGPO	900	adj glides	polished
	27	30 x 96	2	BCKEL30096SDGPO	980	adj glides	polished
	15	20 x 96	2	BCRIA20096SDGME	650	adj glides	standard metal
	22	24 x 96	2	BCRIA24096SDGME	690	adj glides	standard metal
	27	30 x 96	2	BCRIA30096SDGME	740	adj glides	standard metal
	15	20 x 96	2	BCRIA20096SDCME	740	2" black locking casters	standard metal
	22	24 x 96	2	BCRIA24096SDCME	780	2" black locking casters	standard metal
	27	30 x 96	2	BCRIA30096SDCME	830	2" black locking casters	standard metal
	15	20 x 96	2	BCRIA20096SDGPO	780	adj glides	polished
	22	24 x 96	2	BCRIA24096SDGPO	830	adj glides	polished
	27	30 x 96	2	BCRIA30096SDGPO	870	adj glides	polished
	15	20 x 96	2	BCNOV20096SDCPO	870	2" black locking casters	polished
	22	24 x 96	2	BCNOV24096SDCPO	910	2" black locking casters	polished
	27	30 x 96	2	BCNOV30096SDCPO	960	2" black locking casters	polished
	18	20 x 96	2	BCNOV20096SDGME	640	adj glides	standard metal
	22	24 x 96	2	BCNOV24096SDGME	660	adj glides	standard metal
	26	30 x 96	2	BCNOV30096SDGME	690	adj glides	standard metal
	18	20 x 96	2	BCNOV20096SDCME	730	2" black locking casters	standard metal
	22	24 x 96	2	BCNOV24096SDCME	750	2" black locking casters	standard metal
	26	30 x 96	2	BCNOV30096SDCME	780	2" black locking casters	standard metal
	18	20 x 96	2	BCNOV20096SDHME	750	glides/concealed casters	standard metal
	22	24 x 96	2	BCNOV24096SDHME	770	glides/concealed casters	standard metal
	26	30 x 96	2	BCNOV30096SDHME	800	glides/concealed casters	standard metal
	18	20 x 96	2	BCNOV20096SDGPC	880	adj glides	polished
	22	24 x 96	2	BCNOV24096SDGPC	900	adj glides	polished
	26	30 x 96	2	BCNOV30096SDGPC	940	adj glides	polished
18	20 x 96	2	BCNOV20096SDCPC	970	2" black locking casters	polished	
22	24 x 96	2	BCNOV24096SDCPC	990	2" black locking casters	polished	
26	30 x 96	2	BCNOV30096SDCPC	1,020	2" black locking casters	polished	

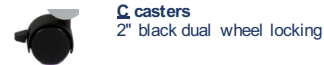

**C casters**  
2" black dual wheel locking

**(ME) Standard metal powder coat finishes :**  
Black Wrinkle (BW), Chateau Brown Wrinkle (CB), Flat Black (FB), Furniture White (FW), Inner Tone (IT), Light Tone (LT), Medium Tone (MT), Metallic Silver (MS).

**(PQ) Polished aluminum / chrome finish (Keller / Ria)**







**H Novi hidden/concealed casters**  
one T base per set has glides, the other base has hidden/concealed casters

**(PC) Polished chrome finish (Novi)**

# bases

## C fixed single column sets

Moto, Moto 2, Zoey

base	base dim.	max top support	base set qty	base set model no.	list	glides or casters	finish
	18	24 x 96	2	BCMOT24096SDGME	830	adj glides	standard metal
	22	30 x 96	2	BCMOT30096SDGME	870	adj glides	standard metal
	26	36 x 96	2	BCMOT36096SDGME	910	adj glides	standard metal
	18	24 x 96	2	BCMOT24096SDCME	910	2" black locking casters	standard metal
	22	30 x 96	2	BCMOT30096SDCME	960	2" black locking casters	standard metal
	26	36 x 96	2	BCMOT36096SDCME	1,000	2" black locking casters	standard metal
	18	24 x 96	2	BCMOT24096SDPME	960	2" premium locking casters	standard metal
	22	30 x 96	2	BCMOT30096SDPME	1,000	2" premium locking casters	standard metal
	26	36 x 96	2	BCMOT36096SDPME	1,050	2" premium locking casters	standard metal
	18	24 x 96	2	BCMO224096SDGME	680	adj glides	standard metal
	22	30 x 96	2	BCMO230096SDGME	720	adj glides	standard metal
	26	36 x 96	2	BCMO236096SDGME	750	adj glides	standard metal
	18	24 x 96	2	BCMO224096SDCME	770	2" black locking casters	standard metal
	22	30 x 96	2	BCMO230096SDCME	800	2" black locking casters	standard metal
	26	36 x 96	2	BCMO236096SDCME	840	2" black locking casters	standard metal
	18	24 x 96	2	BCMO224096SDPME	810	2" premium locking casters	standard metal
	22	30 x 96	2	BCMO230096SDPME	850	2" premium locking casters	standard metal
	26	36 x 96	2	BCMO236096SDPME	880	2" premium locking casters	standard metal
	18	20 x 96	2	BCZOE20096SDGME	570	adj glides	standard metal
	21	24 x 96	2	BCZOE24096SDGME	610	adj glides	standard metal
	27	30 x 96	2	BCZOE30096SDGME	650	adj glides	standard metal
	18	20 x 96	2	BCZOE20096SDCME	660	3" black locking casters	standard metal
	21	24 x 96	2	BCZOE24096SDCME	690	3" black locking casters	standard metal
	27	30 x 96	2	BCZOE30096SDCME	740	3" black locking casters	standard metal
	18	20 x 96	2	BCZOE20096SDPME	700	3" premium locking casters	standard metal
	21	24 x 96	2	BCZOE24096SDPME	740	3" premium locking casters	standard metal
	27	30 x 96	2	BCZOE30096SDPME	780	3" premium locking casters	standard metal



**C casters**  
2" black dual wheel locking (Moto, Moto 2)  
3" black dual wheel locking (Zoey)



**P premium casters**  
2" silver/black dual wheel locking - (Moto, Moto 2)  
3" white dual wheel locking (Zoey)



**(ME) Standard metal powder coat finishes :**  
Black Wrinkle (BW), Chateau Brown Wrinkle (CB), Flat Black (FB), Furniture White (FW), Inner Tone (IT), Light Tone (LT), Medium Tone (MT), Metallic Silver (MS).



# bases

## C nesting sets

### Keller, Ria, Novi

base	base dim.	max top support	base set qty	base set model no.	list	glides or casters	finish
	15	20 x 72	2	BCKEL20072NEGME	1,240	adj glides	standard metal
	22	24 x 72	2	BCKEL24072NEGME	1,290	adj glides	standard metal
	27	30 x 72	2	BCKEL30072NEGME	1,340	adj glides	standard metal
	15	20 x 72	2	BCKEL20072NECME	1,330	2" black locking casters	standard metal
	22	24 x 72	2	BCKEL24072NECME	1,380	2" black locking casters	standard metal
	27	30 x 72	2	BCKEL30072NECME	1,430	2" black locking casters	standard metal
	15	20 x 72	2	BCKEL20072NEGPO	1,380	adj glides	polished
	22	24 x 72	2	BCKEL24072NEGPO	1,420	adj glides	polished
	27	30 x 72	2	BCKEL30072NEGPO	1,470	adj glides	polished
	15	20 x 72	2	BCRIA20072NEGME	1,170	adj glides	standard metal
	22	24 x 72	2	BCRIA24072NEGME	1,190	adj glides	standard metal
	27	30 x 72	2	BCRIA30072NEGME	1,220	adj glides	standard metal
	15	20 x 72	2	BCRIA20072NECME	1,250	2" black locking casters	standard metal
	22	24 x 72	2	BCRIA24072NECME	1,280	2" black locking casters	standard metal
	27	30 x 72	2	BCRIA30072NECME	1,310	2" black locking casters	standard metal
	15	20 x 72	2	BCRIA20072NEGPO	1,300	adj glides	polished
	22	24 x 72	2	BCRIA24072NEGPO	1,320	adj glides	polished
	27	30 x 72	2	BCRIA30072NEGPO	1,350	adj glides	polished
	15	20 x 72	2	BCNOV20072NECPO	1,390	2" black locking casters	polished
	22	24 x 72	2	BCNOV24072NECPO	1,410	2" black locking casters	polished
	27	30 x 72	2	BCNOV30072NECPO	1,440	2" black locking casters	polished
	18	20 x 72	2	BCNOV20072NEGME	1,250	adj glides	standard metal
	22	24 x 72	2	BCNOV24072NEGME	1,280	adj glides	standard metal
	26	30 x 72	2	BCNOV30072NEGME	1,290	adj glides	standard metal
	18	20 x 72	2	BCNOV20072NECME	1,340	2" black locking casters	standard metal
	22	24 x 72	2	BCNOV24072NECME	1,360	2" black locking casters	standard metal
	26	30 x 72	2	BCNOV30072NECME	1,380	2" black locking casters	standard metal

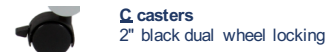

**(ME) Standard metal powder coat finishes :**  
Black Wrinkle (BW), Chateau Brown Wrinkle (CB), Flat Black (FB), Furniture White (FW), Inner Tone (IT), Light Tone (LT), Medium Tone (MT), Metallic Silver (MS).

**(PQ) Polished aluminum / chrome finish (Keller / Ria)**

**KELLER, RIA, ROSANNO AND NOVI SINGLE T FLIP MECH**  
IMAGE:





Note that the Keller, Ria and Novi single column series bases do not have a beam and therefore the bases cannot be spread more than 50" apart at center.

# bases

## C nesting sets

### Zoey, Moto

base	base dim.	max top support	base set qty	base set model no.	list	glides or casters	finish	
	15	20 x 60	2	BCZOE20060NBGME	1,290	adj glides	standard metal	
	15	20 x 72	2	BCZOE20072NBGME	1,310	adj glides	standard metal	
	21	24 x 60	2	BCZOE24060NBGME	1,310	adj glides	standard metal	
	21	24 x 72	2	BCZOE24072NBGME	1,330	adj glides	standard metal	
	27	30 x 60	2	BCZOE30060NBGME	1,330	adj glides	standard metal	
	27	30 x 72	2	BCZOE30072NBGME	1,350	adj glides	standard metal	
	15	20 x 60	2	BCZOE20060NBCME	1,380	3" black locking casters	standard metal	
	15	20 x 72	2	BCZOE20072NBCME	1,400	3" black locking casters	standard metal	
	21	24 x 60	2	BCZOE24060NBCME	1,400	3" black locking casters	standard metal	
	21	24 x 72	2	BCZOE24072NBCME	1,420	3" black locking casters	standard metal	
	27	30 x 60	2	BCZOE30060NBCME	1,420	3" black locking casters	standard metal	
	27	30 x 72	2	BCZOE30072NBCME	1,440	3" black locking casters	standard metal	
		15	20 x 60	2	BCZOE20060NBPME	1,330	3" premium locking casters	standard metal
		15	20 x 72	2	BCZOE20072NBPME	1,350	3" premium locking casters	standard metal
		21	24 x 60	2	BCZOE24060NBPME	1,350	3" premium locking casters	standard metal
21		24 x 72	2	BCZOE24072NBPME	1,380	3" premium locking casters	standard metal	
27		30 x 60	2	BCZOE30060NBPME	1,380	3" premium locking casters	standard metal	
27		30 x 72	2	BCZOE30072NBPME	1,400	3" premium locking casters	standard metal	
		18	24 x 60	2	BCMO224060NBGME	1,440	adj glides	standard metal
		18	24 x 72	2	BCMO230072NBGME	1,450	adj glides	standard metal
		22	30 x 60	2	BCMO230060NBGME	1,470	adj glides	standard metal
	22	30 x 72	2	BCMO230072NBGME	1,490	adj glides	standard metal	
	18	24 x 60	2	BCMO224060NBCME	1,530	2" black locking casters	standard metal	
	18	24 x 72	2	BCMO230072NBCME	1,540	2" black locking casters	standard metal	
	22	30 x 60	2	BCMO230060NBCME	1,560	2" black locking casters	standard metal	
	22	30 x 72	2	BCMO230072NBCME	1,570	2" black locking casters	standard metal	
	18	24 x 72	2	BCMO224060NBPME	1,570	2" premium locking casters	standard metal	
18	24 x 72	2	BCMO230072NBPME	1,580	2" premium locking casters	standard metal		
22	30 x 60	2	BCMO230060NBPME	1,610	2" premium locking casters	standard metal		
22	30 x 72	2	BCMO230072NBPME	1,620	2" premium locking casters	standard metal		

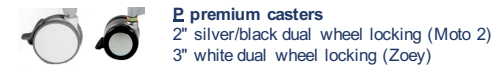
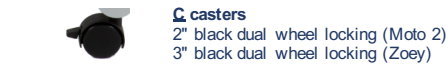

**(ME) Standard metal powder coat finishes :**  
Black Wrinkle (BW), Chateau Brown Wrinkle (CB), Flat Black (FB), Furniture White (FW), Inner Tone (IT), Light Tone (LT), Medium Tone (MT), Metallic Silver (MS).

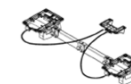







**Zoey and Moto flip nest bases with a beam do not require top stiffeners**

The cost of the top stiffener is included in the standard Symphony top price.  
Deduct the following from the list price shown for a top in the top section of the price list  
-\$40 list for tops that are up to 24" deep (1 stiffener)  
-\$80 list for tops that are up to 36" deep (2 stiffeners)

The flip mechanisms vary by base series, contact [service@symphonytables.com](mailto:service@symphonytables.com) for more information.

# bases

C adjustable height sets  
Keller, Ria, Novi, Moto, Kenna

base	base dim.	max top support	base set qty	base set model no.	list	glides or casters	finish		
Keller 	spring clip	15	20 x 72	2	BCKEL20072SSGME	1,080	adj glides	standard metal	
		22	24 x 72	2	BCKEL24072SSGME	1,120	adj glides	standard metal	
		27	30 x 72	2	BCKEL30072SSGME	1,180	adj glides	standard metal	
	Ria 	spring clip	15	20 x 72	2	BCRIA20072SSGME	990	adj glides	standard metal
			22	24 x 72	2	BCRIA24072SSGME	1,010	adj glides	standard metal
			27	30 x 72	2	BCRIA30072SSGME	1,060	adj glides	standard metal
Novi 	spring clip	15	20 x 72	2	BCNOV20072SSGME	1,080	2" black locking casters	standard metal	
		22	24 x 72	2	BCNOV24072SSGME	1,100	2" black locking casters	standard metal	
		27	30 x 72	2	BCNOV30072SSGME	1,140	2" black locking casters	standard metal	
	Moto (3" column) 	crank	18	20 x 72	2	BCMOT20072SSGME	960	adj glides	standard metal
			22	24 x 72	2	BCMOT24072SSGME	990	adj glides	standard metal
			26	30 x 72	2	BCMOT30072SSGME	1,010	adj glides	standard metal
Kenna Single Stage Electric 	basic up/down switch	18	20 x 72	2	BCMOT20072SSGME	1,050	2" black locking casters	standard metal	
		22	24 x 72	2	BCMOT24072SSGME	1,080	2" black locking casters	standard metal	
		26	30 x 72	2	BCMOT30072SSGME	1,100	2" black locking casters	standard metal	
	programmable switch	18	20 x 72	2	BCMOT20072SSGME	1,050	2" black locking casters	standard metal	
		22	24 x 72	2	BCMOT24072SSGME	1,080	2" black locking casters	standard metal	
		26	30 x 72	2	BCMOT30072SSGME	1,100	2" black locking casters	standard metal	
Kenna Dual Stage Electric 	basic up/down switch	18	24 x 72	2	BCMOT24072SEGME	2,680	adj glides	standard metal	
		22	30 x 72	2	BCMOT30072SEGME	2,700	adj glides	standard metal	
		26	36 x 72	2	BCMOT36072SEGME	2,720	adj glides	standard metal	
	programmable switch	18	24 x 72	2	BCMOT24072SPGME	2,830	adj glides	standard metal	
		22	30 x 72	2	BCMOT30072SPGME	2,840	adj glides	standard metal	
		26	36 x 72	2	BCMOT36072SPGME	2,860	adj glides	standard metal	

**C casters**  
2" black dual wheel locking

**Standard metal powder coat finishes (ME)**  
Flat Black, Furniture White, Inner Tone, Light Tone, Medium Tone, and Metallic Silver

\*\* Note that the inner column of Moto and Kenna height adjustable bases are only available in black, white or metallic silver. Note that Moto White is a shade off and a little creamier than Furniture White.

**S Spring clip height adjustment**  
24.75" - 33.75" (Ria, Keller, Novi)  
range in 1" increments  
available for C base tables up to 30" deep

**C Crank adjustment (Moto)**  
base height with glides 26" - 43.75" (17.75" range)  
base height with casters 28" - 45.75"  
-screw thread adjustment with infinite stop positions  
-adjust with manual crank handle which slides under table when not in use  
-maximum lifting load 225 lbs for two columns (C base set)

**E Electric adj. 26" - 45.75" (Moto)**  
- touch switch for infinite stop positions  
adjustment speed 1.97" per second  
- simple up-down or programmable keypad control  
- maximum lifting load 225 lbs for 2 columns (set of C bases)



**SEG Single Stage Electric adj. 27" - 46" (Kenna)**  
- basic up / down switch / undersurface mount  
- adjustment speed 1.375" per second

**SPG Single Stage Electric adj. 27" - 46" (Kenna)**  
-programmable keypad / under surface mount  
-4 preset programmable heights  
-shelf stop and container stop feature that will stop raising or lowering the worksurface if there are items above or below the worksurface that could impact the table  
-digital display  
- adjustment speed 1.375" per second

**Kenna weight capacity:**

# bases

C adjustable height sets  
Matt II

base	base dim.	max top support	base set qty	base set model no.	list	glides	finish	
Matt II Electric height adjustable C Single Stage Electric 	basic up/down switch	23	24 x 48-72	2	BCMA224072SEGFB	1,170	adj glides	flat black
		23	24 x 48-72	2	BCMA224072SEGFW	1,170	adj glides	furniture white
		23	24 x 48-72	2	BCMA224072SEGMS	1,170	adj glides	metallic silver
		28	30 x 48-72	2	BCMA230072SEGFB	1,210	adj glides	flat black
		28	30 x 48-72	2	BCMA230072SEGFW	1,210	adj glides	furniture white
		28	30 x 48-72	2	BCMA230072SEGMS	1,210	adj glides	metallic silver
	programmable switch	23	24 x 48-72	2	BCMA224072SPGFB	1,250	adj glides	flat black
		23	24 x 48-72	2	BCMA224072SPGFW	1,250	adj glides	furniture white
		23	24 x 48-72	2	BCMA224072SPGMS	1,250	adj glides	metallic silver
		28	30 x 48-72	2	BCMA230072SPGFB	1,290	adj glides	flat black
		28	30 x 48-72	2	BCMA230072SPGFW	1,290	adj glides	furniture white
		28	30 x 48-72	2	BCMA230072SPGMS	1,290	adj glides	metallic silver
Dual Stage Electric 	basic up/down switch	23	24 x 48-72	2	BCMA324072DEGFB	1,230	adj glides	flat black
		23	24 x 48-72	2	BCMA324072DEGFW	1,230	adj glides	furniture white
		23	24 x 48-72	2	BCMA324072DEGMS	1,230	adj glides	metallic silver
	programmable switch	28	30 x 48-72	2	BCMA330072DEGFB	1,270	adj glides	flat black
		28	30 x 48-72	2	BCMA330072DEGFW	1,270	adj glides	furniture white
		28	30 x 48-72	2	BCMA330072DEGMS	1,270	adj glides	metallic silver
basic up/down switch w/ sensor control	23	24 x 48-72	2	BCMA324072DEGFB	1,310	adj glides	flat black	
	23	24 x 48-72	2	BCMA324072DEGFW	1,310	adj glides	furniture white	
	23	24 x 48-72	2	BCMA324072DEGMS	1,310	adj glides	metallic silver	
	28	30 x 48-72	2	BCMA330072DEGFB	1,340	adj glides	flat black	
	28	30 x 48-72	2	BCMA330072DEGFW	1,340	adj glides	furniture white	
	28	30 x 48-72	2	BCMA330072DEGMS	1,340	adj glides	metallic silver	
programmable switch w/ sensor control	23	24 x 48-72	2	BCMA324072DPGFB	1,450	adj glides	flat black	
	23	24 x 48-72	2	BCMA324072DPGFW	1,450	adj glides	furniture white	
	23	24 x 48-72	2	BCMA324072DPGMS	1,450	adj glides	metallic silver	
	28	30 x 48-72	2	BCMA330072DPGFB	1,480	adj glides	flat black	
	28	30 x 48-72	2	BCMA330072DPGFW	1,480	adj glides	furniture white	
	28	30 x 48-72	2	BCMA330072DPGMS	1,480	adj glides	metallic silver	

\* top not included

**SEG** Single Stage Electric adj. 26" - 45"  
**DEG** Dual Stage Electric adj. 21.75" - 47.75"  
- basic up / down switch / undersurface mount  
- adjustment speed 1.375" per second

**SPG** Single Stage Electric adj. 26" - 45"  
**DPG** Dual Stage Electric adj. 21.75" - 47.75"  
-programmable keypad / under surface mount  
-4 preset programmable heights  
-digital display  
-adjustment speed 1.375" per second

**Matt Standard metal finish options**  
**FB** Flat Black  
**FW** Furniture White  
**MS** Metallic Silver

**Sensor control**  
Sensor - collision mitigation option significantly increases the safety of the height adjustable table. It detects collision when the table is moved and can significantly reduce damage to the table and the colliding object.

**Matt weight capacity:**  
- maximum lifting load 250 lbs. for (2) C bases (including the top)





# bases

## X and Y fixed

### Keller

base	base dim.	max top support	base qty	base model no.	list	glides or casters	finish
Keller 27.75"H X	20 x 20	24 x 24, 24 rd	1	BXKEL24024SDGME	610	adj glides	standard metal
	26 x 26	30 x 30, 36 rd	1	BXKEL30030SDGME	660	adj glides	standard metal
	33 x 33	36 x 36, 42 rd	1	BXKEL36036SDGME	720	adj glides	standard metal
	38 x 38	42 x 42, 48 rd	1	BXKEL42042SDGME	840	adj glides	standard metal
	20 x 20	24 x 24, 24 rd	1	BXKEL24024SDCME	690	2" black locking casters	standard metal
	26 x 26	30 x 30, 36 rd	1	BXKEL30030SDCME	750	2" black locking casters	standard metal
	33 x 33	36 x 36, 42 rd	1	BXKEL36036SDCME	800	2" black locking casters	standard metal
	38 x 38	42 x 42, 48 rd	1	BXKEL42042SDCME	920	2" black locking casters	standard metal
	20 x 20	24 x 24, 24 rd	1	BXKEL24024SDGPO	690	adj glides	polished
	26 x 26	30 x 30, 36 rd	1	BXKEL30030SDGPO	750	adj glides	polished
	33 x 33	36 x 36, 42 rd	1	BXKEL36036SDGPO	800	adj glides	polished
	38 x 38	42 x 42, 48 rd	1	BXKEL42042SDGPO	920	adj glides	polished
40.75"H X	20 x 20	24 x 24, 24 rd	1	BXKEL24024SDCPO	780	2" black locking casters	polished
	26 x 26	30 x 30, 36 rd	1	BXKEL30030SDCPO	840	2" black locking casters	polished
	33 x 33	36 x 36, 42 rd	1	BXKEL36036SDCPO	890	2" black locking casters	polished
	38 x 38	42 x 42, 48 rd	1	BXKEL42042SDCPO	1,010	2" black locking casters	polished
	20 x 20	24 x 24, 24 rd	1	BXKEL24024SBGME	690	adj glides	standard metal
	26 x 26	30 x 30, 36 rd	1	BXKEL30030SBGME	750	adj glides	standard metal
	33 x 33	36 x 36, 42 rd	1	BXKEL36036SBGME	800	adj glides	standard metal
	38 x 38	42 x 42, 48 rd	1	BXKEL42042SBGME	920	adj glides	standard metal
	20 x 20	24 x 24, 24 rd	1	BXKEL24024SBCME	780	2" black locking casters	standard metal
	26 x 26	30 x 30, 36 rd	1	BXKEL30030SBCME	840	2" black locking casters	standard metal
	33 x 33	36 x 36, 42 rd	1	BXKEL36036SBCME	890	2" black locking casters	standard metal
	38 x 38	42 x 42, 48 rd	1	BXKEL42042SBCME	1,010	2" black locking casters	standard metal
	20 x 20	24 x 24, 24 rd	1	BXKEL24024SBGPO	780	adj glides	polished
	26 x 26	30 x 30, 36 rd	1	BXKEL30030SBGPO	840	adj glides	polished
	33 x 33	36 x 36, 42 rd	1	BXKEL36036SBGPO	890	adj glides	polished
	38 x 38	42 x 42, 48 rd	1	BXKEL42042SBGPO	1,010	adj glides	polished
	20 x 20	24 x 24, 24 rd	1	BXKEL24024SBCPO	870	2" black locking casters	polished
	26 x 26	30 x 30, 36 rd	1	BXKEL30030SBCPO	920	2" black locking casters	polished
	33 x 33	36 x 36, 42 rd	1	BXKEL36036SBCPO	980	2" black locking casters	polished
	38 x 38	42 x 42, 48 rd	1	BXKEL42042SBCPO	1,100	2" black locking casters	polished

For complete custom lower height or custom higher height base model number:

1. Insert height selection:

**SH** custom Higher fixed height - specify height

**SL** custom Lower fixed height - specify height

custom height X	base dim.	max top support	base qty	base model no.	list	glides or casters	finish
20 x 20	24 x 24, 24 rd	24 rd	1	BXKEL24024_GME	690	adj glides	standard metal
26 x 26	30 x 30, 36 rd	36 rd	1	BXKEL30030_GME	750	adj glides	standard metal
33 x 33	36 x 36, 42 rd	42 rd	1	BXKEL36036_GME	800	adj glides	standard metal
38 x 38	42 x 42, 48 rd	48 rd	1	BXKEL42042_GME	920	adj glides	standard metal
20 x 20	24 x 24, 24 rd	24 rd	1	BXKEL24024_CME	780	2" black locking casters	standard metal
26 x 26	30 x 30, 36 rd	36 rd	1	BXKEL30030_CME	840	2" black locking casters	standard metal
33 x 33	36 x 36, 42 rd	42 rd	1	BXKEL36036_CME	890	2" black locking casters	standard metal
38 x 38	42 x 42, 48 rd	48 rd	1	BXKEL42042_CME	1,010	2" black locking casters	standard metal
20 x 20	24 x 24, 24 rd	24 rd	1	BXKEL24024_GPO	780	adj glides	polished
26 x 26	30 x 30, 36 rd	36 rd	1	BXKEL30030_GPO	840	adj glides	polished
33 x 33	36 x 36, 42 rd	42 rd	1	BXKEL36036_GPO	890	adj glides	polished
38 x 38	42 x 42, 48 rd	48 rd	1	BXKEL42042_GPO	1,010	adj glides	polished
20 x 20	24 x 24, 24 rd	24 rd	1	BXKEL24024_CPO	870	2" black locking casters	polished
26 x 26	30 x 30, 36 rd	36 rd	1	BXKEL30030_CPO	920	2" black locking casters	polished
33 x 33	36 x 36, 42 rd	42 rd	1	BXKEL36036_CPO	980	2" black locking casters	polished
38 x 38	42 x 42, 48 rd	48 rd	1	BXKEL42042_CPO	1,100	2" black locking casters	polished

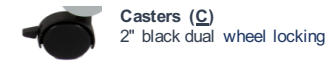

**Casters (C)**  
2" black dual wheel locking

**Standard metal powder coat finishes (ME)**  
Black Wrinkle, Chateau Brown Wrinkle, Flat Black, Furniture White, Inner Tone, Light Tone, Medium Tone and Metallic Silver

**Premium Polished Finish (PO)**  
Polished Aluminum/Steel

# bases

## X and Y fixed

### Keller

base	base dim.	max top support	base qty	base model no.	list	glides or casters	finish	
Keller 27.75"H offset X	20 x 26	24 x 30	1	BXKEL24030SDGME	650	adj glides	standard metal	
	20 x 33	24 x 36	1	BXKEL24036SDGME	680	adj glides	standard metal	
	20 x 38	24 x 42	1	BXKEL24042SDGME	780	adj glides	standard metal	
	26 x 33	30 x 36	1	BXKEL30036SDGME	700	adj glides	standard metal	
	26 x 38	30 x 42	1	BXKEL30042SDGME	680	adj glides	standard metal	
	33 x 38	36 x 42	1	BXKEL36042SDGME	830	adj glides	standard metal	
	20 x 26	24 x 30	1	BXKEL24030SDCME	740	2" black locking casters	standard metal	
	20 x 33	24 x 36	1	BXKEL24036SDCME	770	2" black locking casters	standard metal	
	20 x 38	24 x 42	1	BXKEL24042SDCME	870	2" black locking casters	standard metal	
	26 x 33	30 x 36	1	BXKEL30036SDCME	790	2" black locking casters	standard metal	
	26 x 38	30 x 42	1	BXKEL30042SDCME	770	2" black locking casters	standard metal	
	33 x 38	36 x 42	1	BXKEL36042SDCME	910	2" black locking casters	standard metal	
27.75"H Y	20 x 26	24 x 30	1	BXKEL24030SDGPO	740	adj glides	polished	
	20 x 33	24 x 36	1	BXKEL24036SDGPO	770	adj glides	polished	
	20 x 38	24 x 42	1	BXKEL24042SDGPO	870	adj glides	polished	
	26 x 33	30 x 36	1	BXKEL30036SDGPO	790	adj glides	polished	
	26 x 38	30 x 42	1	BXKEL30042SDGPO	770	adj glides	polished	
	33 x 38	36 x 42	1	BXKEL36042SDGPO	910	adj glides	polished	
	20 x 26	24 x 30	1	BXKEL24030SDCPO	830	2" black locking casters	polished	
	20 x 33	24 x 36	1	BXKEL24036SDCPO	860	2" black locking casters	polished	
	20 x 38	24 x 42	1	BXKEL24042SDCPO	960	2" black locking casters	polished	
	26 x 33	30 x 36	1	BXKEL30036SDCPO	880	2" black locking casters	polished	
	26 x 38	30 x 42	1	BXKEL30042SDCPO	860	2" black locking casters	polished	
	33 x 38	36 x 42	1	BXKEL36042SDCPO	1,000	2" black locking casters	polished	
	20 x 20	24 x 24, 24 rd	24 rd	1	BYKEL24024SDGME	570	adj glides	standard metal
	26 x 26	30 x 30, 30 rd	30 rd	1	BYKEL30030SDGME	610	adj glides	standard metal
	33 x 33	36 x 36, 36 rd	36 rd	1	BYKEL36036SDGME	650	adj glides	standard metal
	20 x 20	24 x 24, 24 rd	24 rd	1	BYKEL24024SDCME	660	2" black locking casters	standard metal
	26 x 26	30 x 30, 30 rd	30 rd	1	BYKEL30030SDCME	690	2" black locking casters	standard metal
	33 x 33	36 x 36, 36 rd	36 rd	1	BYKEL36036SDCME	740	2" black locking casters	standard metal
	20 x 20	24 x 24, 24 rd	24 rd	1	BYKEL24024SDGPO	660	adj glides	polished
	26 x 26	30 x 30, 30 rd	30 rd	1	BYKEL30030SDGPO	690	adj glides	polished
	33 x 33	36 x 36, 36 rd	36 rd	1	BYKEL36036SDGPO	740	adj glides	polished
	20 x 20	24 x 24, 24 rd	24 rd	1	BYKEL24024SDCPO	750	2" black locking casters	polished
	26 x 26	30 x 30, 30 rd	30 rd	1	BYKEL30030SDCPO	780	2" black locking casters	polished
	33 x 33	36 x 36, 36 rd	36 rd	1	BYKEL36036SDCPO	830	2" black locking casters	polished
20 x 20	24 x 24, 24 rd	24 rd	1	BYKEL24024SLGME	660	adj glides	standard metal	
26 x 26	30 x 30, 30 rd	30 rd	1	BYKEL30030SLGME	690	adj glides	standard metal	
33 x 33	36 x 36, 36 rd	36 rd	1	BYKEL36036SLGME	740	adj glides	standard metal	
20 x 20	24 x 24, 24 rd	24 rd	1	BYKEL24024SLCME	750	2" black locking casters	standard metal	
26 x 26	30 x 30, 30 rd	30 rd	1	BYKEL30030SLCME	780	2" black locking casters	standard metal	
33 x 33	36 x 36, 36 rd	36 rd	1	BYKEL36036SLCME	830	2" black locking casters	standard metal	
20 x 20	24 x 24, 24 rd	24 rd	1	BYKEL24024SLGPO	750	adj glides	polished	
26 x 26	30 x 30, 30 rd	30 rd	1	BYKEL30030SLGPO	780	adj glides	polished	
33 x 33	36 x 36, 36 rd	36 rd	1	BYKEL36036SLGPO	830	adj glides	polished	
20 x 20	24 x 24, 24 rd	24 rd	1	BYKEL24024SLCPO	840	2" black locking casters	polished	
26 x 26	30 x 30, 30 rd	30 rd	1	BYKEL30030SLCPO	870	2" black locking casters	polished	
33 x 33	36 x 36, 36 rd	36 rd	1	BYKEL36036SLCPO	910	2" black locking casters	polished	

custom lower height Y

Power module cone shaped top plate - #OBXWMPCC \$350 list

metal cone-shaped top plate conceals and protects center mounted power module in surface.

Concealed wires exit down inside the base column and out at the bottom of the base column.

Available for single column Keller X and Y bases

Note that the cone cannot be made with the polished finish, black or white paint is available for the cone with a polished base. The Circo power unit can be used with this cone wire manager.

Wire management hole set (2) in column - #OBTWMH2G \$50 list

each hole is 1.25" x 2.25". Removeable grommets narrows hole to 1.25" diameter

Available for single column Keller X and Y bases

Note that the wire management grommet cannot be made with the polished finish



# bases

## X and Y fixed

### Ria

base	base dim.	max top support	base qty	base set model no.	list	glides or casters	finish
Ria	27.75"H X	20 x 20 24 x 24, 24 rd	1	BXRIA24024SDGME	510	adj glides	standard metal
		26 x 26 30 x 30, 36 rd	1	BXRIA30030SDGME	550	adj glides	standard metal
		33 x 33 36 x 36, 42 rd	1	BXRIA36036SDGME	640	adj glides	standard metal
		38 x 38 42 x 42, 48 rd	1	BXRIA42042SDGME	720	adj glides	standard metal
	20 x 20 24 x 24, 24 rd	1	BXRIA24024SDCME	590	2" black locking casters	standard metal	
	26 x 26 30 x 30, 36 rd	1	BXRIA30030SDCME	640	2" black locking casters	standard metal	
	33 x 33 36 x 36, 42 rd	1	BXRIA36036SDCME	730	2" black locking casters	standard metal	
	38 x 38 42 x 42, 48 rd	1	BXRIA42042SDCME	800	2" black locking casters	standard metal	
	20 x 20 24 x 24, 24 rd	1	BXRIA24024SDGPO	590	adj glides	polished	
	26 x 26 30 x 30, 36 rd	1	BXRIA30030SDGPO	640	adj glides	polished	
	33 x 33 36 x 36, 42 rd	1	BXRIA36036SDGPO	730	adj glides	polished	
	38 x 38 42 x 42, 48 rd	1	BXRIA42042SDGPO	800	adj glides	polished	
40.75"H X	20 x 20 24 x 24, 24 rd	1	BXRIA24024SDCPO	680	2" black locking casters	polished	
		1	BXRIA30030SDCPO	730	2" black locking casters	polished	
		1	BXRIA36036SDCPO	810	2" black locking casters	polished	
		1	BXRIA42042SDCPO	890	2" black locking casters	polished	
	20 x 20 24 x 24, 24 rd	1	BXRIA24024SBGME	590	adj glides	standard metal	
		1	BXRIA30030SBGME	640	adj glides	standard metal	
		1	BXRIA36036SBGME	730	adj glides	standard metal	
		1	BXRIA42042SBGME	800	adj glides	standard metal	
	20 x 20 24 x 24, 24 rd	1	BXRIA24024SBCME	680	2" black locking casters	standard metal	
		1	BXRIA30030SBCME	730	2" black locking casters	standard metal	
		1	BXRIA36036SBCME	810	2" black locking casters	standard metal	
		1	BXRIA42042SBCME	890	2" black locking casters	standard metal	
	20 x 20 24 x 24, 24 rd	1	BXRIA24024SBGPO	680	adj glides	polished	
		1	BXRIA30030SBGPO	730	adj glides	polished	
		1	BXRIA36036SBGPO	810	adj glides	polished	
		1	BXRIA42042SBGPO	890	adj glides	polished	
	20 x 20 24 x 24, 24 rd	1	BXRIA24024SBCPO	770	2" black locking casters	polished	
		1	BXRIA30030SBCPO	810	2" black locking casters	polished	
		1	BXRIA36036SBCPO	900	2" black locking casters	polished	
		1	BXRIA42042SBCPO	980	2" black locking casters	polished	

For complete custom lower height or custom higher height base model number:

1. Insert height selection:

**SH** custom Higher fixed height - specify height

**SL** custom Lower fixed height - specify height

custom height X	base dim.	max top support	base qty	base set model no.	list	glides or casters	finish
20 x 20 24 x 24, 24 rd	1	BXRIA24024_GME	590	adj glides	standard metal		
	1	BXRIA30030_GME	640	adj glides	standard metal		
	1	BXRIA36036_GME	730	adj glides	standard metal		
	1	BXRIA42042_GME	800	adj glides	standard metal		
20 x 20 24 x 24, 24 rd	1	BXRIA24024_CME	680	2" black locking casters	standard metal		
	1	BXRIA30030_CME	730	2" black locking casters	standard metal		
	1	BXRIA36036_CME	810	2" black locking casters	standard metal		
	1	BXRIA42042_CME	890	2" black locking casters	standard metal		
20 x 20 24 x 24, 24 rd	1	BXRIA24024_GPO	680	adj glides	polished		
	1	BXRIA30030_GPO	730	adj glides	polished		
	1	BXRIA36036_GPO	810	adj glides	polished		
	1	BXRIA42042_GPO	890	adj glides	polished		
20 x 20 24 x 24, 24 rd	1	BXRIA24024_CPO	770	2" black locking casters	polished		
	1	BXRIA30030_CPO	810	2" black locking casters	polished		
	1	BXRIA36036_CPO	900	2" black locking casters	polished		
	1	BXRIA42042_CPO	980	2" black locking casters	polished		



**Casters (C)**  
2" black dual wheel locking

**Standard metal powder coat finishes (ME)**  
Black Wrinkle, Chateau Brown Wrinkle, Flat Black, Furniture White, Inner Tone, Light Tone, Medium Tone and Metallic Silver

**Premium Polished Finish (PO)**  
Polished Aluminum/Steel

# bases

## X and Y fixed

### Ria

base	base dim.	max top support	base qty	base set model no.	list	glides or casters	finish
Ria	27.75"H offset X	20 x 26 24 x 30	1	BXRIA24030SDGME	530	adj glides	standard metal
		20 x 33 24 x 36	1	BXRIA24036SDGME	560	adj glides	standard metal
		20 x 38 24 x 42	1	BXRIA24042SDGME	620	adj glides	standard metal
		26 x 33 30 x 36	1	BXRIA30036SDGME	620	adj glides	standard metal
	26 x 38 30 x 42	1	BXRIA30042SDGME	680	adj glides	standard metal	
	33 x 38 36 x 42	1	BXRIA36042SDGME	690	adj glides	standard metal	
	20 x 26 24 x 30	1	BXRIA24030SDCME	620	2" black locking casters	standard metal	
	20 x 33 24 x 36	1	BXRIA24036SDCME	650	2" black locking casters	standard metal	
	20 x 38 24 x 42	1	BXRIA24042SDCME	700	2" black locking casters	standard metal	
	26 x 33 30 x 36	1	BXRIA30036SDCME	700	2" black locking casters	standard metal	
	26 x 38 30 x 42	1	BXRIA30042SDCME	770	2" black locking casters	standard metal	
	33 x 38 36 x 42	1	BXRIA36042SDCME	780	2" black locking casters	standard metal	
27.75"H Y	20 x 26 24 x 30	1	BXRIA24030SDGPO	620	adj glides	polished	
		1	BXRIA24036SDGPO	650	adj glides	polished	
		1	BXRIA24042SDGPO	700	adj glides	polished	
		1	BXRIA30036SDGPO	700	adj glides	polished	
	26 x 38 30 x 42	1	BXRIA30042SDGPO	770	adj glides	polished	
		1	BXRIA36042SDGPO	780	adj glides	polished	
		20 x 26 24 x 30	1	BXRIA24030SDCPO	700	2" black locking casters	polished
		20 x 33 24 x 36	1	BXRIA24036SDCPO	740	2" black locking casters	polished
	20 x 38 24 x 42	1	BXRIA24042SDCPO	790	2" black locking casters	polished	
	26 x 33 30 x 36	1	BXRIA30036SDCPO	790	2" black locking casters	polished	
	26 x 38 30 x 42	1	BXRIA30042SDCPO	860	2" black locking casters	polished	
	33 x 38 36 x 42	1	BXRIA36042SDCPO	870	2" black locking casters	polished	
	20 x 20 24 x 24, 24 rd	1	BYRIA24024SDGME	500	adj glides	standard metal	
		1	BYRIA30030SDGME	560	adj glides	standard metal	
		1	BYRIA36036SDGME	580	adj glides	standard metal	
		20 x 20 24 x 24, 24 rd	1	BYRIA24024SDCME	580	2" black locking casters	standard metal
	26 x 26 30 x 30, 30 rd	1	BYRIA30030SDCME	650	2" black locking casters	standard metal	
	33 x 33 36 x 36, 36 rd	1	BYRIA36036SDCME	670	2" black locking casters	standard metal	
	20 x 20 24 x 24, 24 rd	1	BYRIA24024SDGPO	580	adj glides	polished	
		1	BYRIA30030SDGPO	650	adj glides	polished	
		1	BYRIA36036SDGPO	670	adj glides	polished	
		20 x 20 24 x 24, 24 rd	1	BYRIA24024SDCPO	670	2" black locking casters	polished
	26 x 26 30 x 30, 30 rd	1	BYRIA30030SDCPO	740	2" black locking casters	polished	
	33 x 33 36 x 36, 36 rd	1	BYRIA36036SDCPO	760	2" black locking casters	polished	
20 x 20 24 x 24, 24 rd	1	BYRIA24024SLGME	580	adj glides	standard metal		
	1	BYRIA30030SLGME	650	adj glides	standard metal		
	1	BYRIA36036SLGME	670	adj glides	standard metal		
	20 x 20 24 x 24, 24 rd	1	BYRIA24024SLCME	670	2" black locking casters	standard metal	
26 x 26 30 x 30, 30 rd	1	BYRIA30030SLCME	740	2" black locking casters	standard metal		
33 x 33 36 x 36, 36 rd	1	BYRIA36036SLCME	760	2" black locking casters	standard metal		
20 x 20 24 x 24, 24 rd	1	BYRIA24024SLGPO	670	adj glides	polished		
	1	BYRIA30030SLGPO	740	adj glides	polished		
	1	BYRIA36036SLGPO	760	adj glides	polished		
	20 x 20 24 x 24, 24 rd	1	BYRIA24024SLCPO	760	2" black locking casters	polished	
26 x 26 30 x 30, 30 rd	1	BYRIA30030SLCPO	830	2" black locking casters	polished		
33 x 33 36 x 36, 36 rd	1	BYRIA36036SLCPO	850	2" black locking casters	polished		

custom lower height Y



Power module cone shaped top plate - #OBXWMPCC \$350 list

metal cone-shaped top plate conceals and protects center mounted power module in surface.

Concealed wires exit down inside the base column and out at the bottom of the base column.

Available for single column Ria X and Y bases

Note that the cone cannot be made with the polished finish, black or white paint is available for the cone with a polished base. The Circo power unit can be used with this cone wire manager.

Wire management hole set (2) in column - #OBTWMH2G \$50 list

each hole is 1.25" x 2.25". Removeable grommets narrows hole to 1.25" diameter

Available for single column Ria X and Y bases

Note that the wire management grommet cannot be made with the polished finish

# bases

X and Y fixed  
Novi

base	base dim.	max top support	base qty	base model no.	list	glides or casters	finish
Novi	27.75"H X	22 x 22 24 x 24, 24 rd	1	BXNOV24024SDGME	500	adj glides	standard metal
		26 x 26 30 x 30, 36 rd	1	BXNOV30030SDGME	510	adj glides	standard metal
		32 x 32 36 x 36, 42 rd	1	BXNOV36036SDGME	570	adj glides	standard metal
		38 x 38 42 x 42, 48 rd	1	BXNOV42042SDGME	640	adj glides	standard metal
	40.75"H X	22 x 22 24 x 24, 24 rd	1	BXNOV24024SDCME	580	2" black locking casters	standard metal
			1	BXNOV30030SDCME	590	2" black locking casters	standard metal
			1	BXNOV36036SDCME	660	2" black locking casters	standard metal
			1	BXNOV42042SDCME	730	2" black locking casters	standard metal
		26 x 26 30 x 30, 36 rd	1	BXNOV24024SDGPC	720	adj glides	polished
			1	BXNOV30030SDGPC	730	adj glides	polished
			1	BXNOV36036SDGPC	790	adj glides	polished
			1	BXNOV42042SDGPC	860	adj glides	polished
32 x 32 36 x 36, 42 rd		1	BXNOV24024SDCPC	800	2" black locking casters	polished	
		1	BXNOV30030SDCPC	810	2" black locking casters	polished	
		1	BXNOV36036SDCPC	880	2" black locking casters	polished	
		1	BXNOV42042SDCPC	950	2" black locking casters	polished	
40.75"H X	22 x 22 24 x 24, 24 rd	1	BXNOV24024SBGME	580	adj glides	standard metal	
		1	BXNOV30030SBGME	590	adj glides	standard metal	
		1	BXNOV36036SBGME	660	adj glides	standard metal	
		1	BXNOV42042SBGME	730	adj glides	standard metal	
	26 x 26 30 x 30, 36 rd	1	BXNOV24024SBCME	670	2" black locking casters	standard metal	
		1	BXNOV30030SBCME	680	2" black locking casters	standard metal	
		1	BXNOV36036SBCME	750	2" black locking casters	standard metal	
		1	BXNOV42042SBCME	810	2" black locking casters	standard metal	
	32 x 32 36 x 36, 42 rd	1	BXNOV24024SBGPC	800	adj glides	polished	
		1	BXNOV30030SBGPC	810	adj glides	polished	
		1	BXNOV36036SBGPC	880	adj glides	polished	
		1	BXNOV42042SBGPC	950	adj glides	polished	
38 x 38 42 x 42, 48 rd	1	BXNOV24024SBCPC	890	2" black locking casters	polished		
	1	BXNOV30030SBCPC	900	2" black locking casters	polished		
	1	BXNOV36036SBCPC	970	2" black locking casters	polished		
	1	BXNOV42042SBCPC	###	2" black locking casters	polished		



For complete custom lower height or custom higher height base model number:

1. Insert height selection:  
**SH** custom Higher fixed height - specify height  
**SL** custom Lower fixed height - specify height

custom height X	base dim.	max top support	base qty	base model no.	list	glides or casters	finish
22 x 22 24 x 24, 24 rd	22 x 22 24 x 24, 24 rd	1	BXNOV24024__GME	580	adj glides	standard metal	
		1	BXNOV30030__GME	590	adj glides	standard metal	
		1	BXNOV36036__GME	660	adj glides	standard metal	
		1	BXNOV42042__GME	730	adj glides	standard metal	
	26 x 26 30 x 30, 36 rd	1	BXNOV24024__CME	670	2" black locking casters	standard metal	
		1	BXNOV30030__CME	680	2" black locking casters	standard metal	
		1	BXNOV36036__CME	750	2" black locking casters	standard metal	
		1	BXNOV42042__CME	810	2" black locking casters	standard metal	
	32 x 32 36 x 36, 42 rd	1	BXNOV24024__GPC	800	adj glides	polished	
		1	BXNOV30030__GPC	810	adj glides	polished	
		1	BXNOV36036__GPC	880	adj glides	polished	
		1	BXNOV42042__GPC	950	adj glides	polished	
38 x 38 42 x 42, 48 rd	1	BXNOV24024__CPC	890	2" black locking casters	polished		
	1	BXNOV30030__CPC	900	2" black locking casters	polished		
	1	BXNOV36036__CPC	970	2" black locking casters	polished		
	1	BXNOV42042__CPC	###	2" black locking casters	polished		

# bases

X and Y fixed  
Novi, Rosanno

base	base dim.	max top support	base qty	base model no.	list	glides or casters	finish	
Novi	27.75"H offset	22 x 26 24 x 30	1	BXNOV24030SDGME	510	adj glides	standard metal	
		26 x 36 30 x 42	1	BXNOV30042SDGME	560	adj glides	standard metal	
		22 x 26 24 x 30	1	BXNOV24030SDCME	590	2" black locking casters	standard metal	
		26 x 36 30 x 42	1	BXNOV30042SDCME	650	2" black locking casters	standard metal	
	Rosanno	27.75"H X	22 x 26 24 x 30	1	BXNOV24030SDGPC	730	adj glides	polished
			26 x 36 30 x 42	1	BXNOV30042SDGPC	780	adj glides	polished
			22 x 26 24 x 30	1	BXNOV24030SDCPC	810	2" black locking casters	polished
			26 x 36 30 x 42	1	BXNOV30042SDCPC	870	2" black locking casters	polished
		40.75"H X	26 x 26 30 x 30, 36 rd	1	BXROSD30030SDGME	610	adj glides	standard metal
				1	BXROSD36036SDGME	650	adj glides	standard metal
				1	BXROSD42042SDGME	770	adj glides	standard metal
				1	BXROSD30030SDCME	690	2" black locking casters	standard metal
32 x 32 36 x 36, 42 rd			1	BXROSD36036SDCME	740	2" black locking casters	standard metal	
			1	BXROSD42042SDCME	860	2" black locking casters	standard metal	
			1	BXROSD30030SDGPC	830	adj glides	polished	
			1	BXROSD36036SDGPC	870	adj glides	polished	
38 x 38 42 x 42, 48 rd	1		BXROSD42042SDGPC	990	adj glides	polished		
	1		BXROSD30030SDCPC	910	2" black locking casters	polished		
	1		BXROSD36036SDCPC	960	2" black locking casters	polished		
	1		BXROSD42042SDCPC	1,080	2" black locking casters	polished		
40.75"H X	26 x 26 30 x 30, 36 rd	1	BXROSD30030SBGME	610	adj glides	standard metal		
		1	BXROSD36036SBGME	650	adj glides	standard metal		
		1	BXROSD42042SBGME	770	adj glides	standard metal		
		1	BXROSD30030SBCME	870	2" black locking casters	standard metal		
	32 x 32 36 x 36, 42 rd	1	BXROSD36036SBCME	910	2" black locking casters	standard metal		
		1	BXROSD42042SBCME	1,030	2" black locking casters	standard metal		
		1	BXROSD30030SBGPC	1,000	adj glides	polished		
		1	BXROSD36036SBGPC	1,050	adj glides	polished		
	38 x 38 42 x 42, 48 rd	1	BXROSD42042SBGPC	1,170	adj glides	polished		
		1	BXROSD30030SBCPC	1,090	2" black locking casters	polished		
		1	BXROSD36036SBCPC	1,130	2" black locking casters	polished		
		1	BXROSD42042SBCPC	1,250	2" black locking casters	polished		



For complete custom lower height or custom higher height base model number:

1. Insert height selection:  
**SH** custom Higher fixed height - specify height  
**SL** custom Lower fixed height - specify height

custom height X	base dim.	max top support	base qty	base model no.	list	glides or casters	finish
26 x 26 30 x 30, 36 rd	26 x 26 30 x 30, 36 rd	1	BXROSD30030__GME	780	adj glides	standard metal	
		1	BXROSD36036__GME	830	adj glides	standard metal	
		1	BXROSD42042__GME	950	adj glides	standard metal	
		1	BXROSD30030__CME	870	2" black locking casters	standard metal	
	32 x 32 36 x 36, 42 rd	1	BXROSD36036__CME	910	2" black locking casters	standard metal	
		1	BXROSD42042__CME	1,030	2" black locking casters	standard metal	
		1	BXROSD30030__GPC	1,000	adj glides	polished	
		1	BXROSD36036__GPC	1,050	adj glides	polished	
	38 x 38 42 x 42, 48 rd	1	BXROSD42042__GPC	1,170	adj glides	polished	
		1	BXROSD30030__CPC	1,090	2" black locking casters	polished	
		1	BXROSD36036__CPC	1,130	2" black locking casters	polished	
		1	BXROSD42042__CPC	1,250	2" black locking casters	polished	



**Casters (C)**  
2" black dual wheel locking

**Standard metal powder coat finishes (ME)**  
Black Wrinkle, Chateau Brown Wrinkle, Flat Black, Furniture White, Inner Tone, Light Tone, Medium Tone and Metallic Silver

**Premium Polished Finish (PC)**  
Polished Chrome



# bases

## X and Y fixed

### Moto

base	base dim.	max top support	base qty	base model no.	list	glides or casters	finish	
Moto 	27.75"H X	22 x 22 24 x 24, 30 rd	1	BXMOT24024SDGME	660	adj glides	standard metal	
		26 x 26 30 x 30, 36 rd	1	BXMOT30030SDGME	700	adj glides	standard metal	
		32 x 32 36 x 36, 42 rd	1	BXMOT36036SDGME	760	adj glides	standard metal	
		36 x 36 42 x 42, 48 rd	1	BXMOT42042SDGME	780	adj glides	standard metal	
	40.75"H X	22 x 22 24 x 24, 30 rd	22 x 22 24 x 24, 30 rd	1	BXMOT24024SDCME	750	2" black locking casters	standard metal
			26 x 26 30 x 30, 36 rd	1	BXMOT30030SDCME	790	2" black locking casters	standard metal
			32 x 32 36 x 36, 42 rd	1	BXMOT36036SDCME	850	2" black locking casters	standard metal
			36 x 36 42 x 42, 48 rd	1	BXMOT42042SDCME	870	2" black locking casters	standard metal
		22 x 22 24 x 24, 30 rd	22 x 22 24 x 24, 30 rd	1	BXMOT24024SDPME	790	2" premium locking casters	standard metal
			26 x 26 30 x 30, 36 rd	1	BXMOT30030SDPME	840	2" premium locking casters	standard metal
			32 x 32 36 x 36, 42 rd	1	BXMOT36036SDPME	890	2" premium locking casters	standard metal
			36 x 36 42 x 42, 48 rd	1	BXMOT42042SDPME	910	2" premium locking casters	standard metal
custom higher height X (specify height)		22 x 22 24 x 24, 30 rd	22 x 22 24 x 24, 30 rd	1	BXMOT24024SBGME	750	adj glides	standard metal
			26 x 26 30 x 30, 36 rd	1	BXMOT30030SBGME	790	adj glides	standard metal
			32 x 32 36 x 36, 42 rd	1	BXMOT36036SBGME	850	adj glides	standard metal
			36 x 36 42 x 42, 48 rd	1	BXMOT42042SBGME	870	adj glides	standard metal
	22 x 22 24 x 24, 30 rd	22 x 22 24 x 24, 30 rd	1	BXMOT24024SBCME	840	2" black locking casters	standard metal	
		26 x 26 30 x 30, 36 rd	1	BXMOT30030SBCME	880	2" black locking casters	standard metal	
		32 x 32 36 x 36, 42 rd	1	BXMOT36036SBCME	940	2" black locking casters	standard metal	
		36 x 36 42 x 42, 48 rd	1	BXMOT42042SBCME	960	2" black locking casters	standard metal	
	22 x 22 24 x 24, 30 rd	22 x 22 24 x 24, 30 rd	1	BXMOT24024SBPME	880	2" premium locking casters	standard metal	
		26 x 26 30 x 30, 36 rd	1	BXMOT30030SBPME	920	2" premium locking casters	standard metal	
		32 x 32 36 x 36, 42 rd	1	BXMOT36036SBPME	980	2" premium locking casters	standard metal	
		36 x 36 42 x 42, 48 rd	1	BXMOT42042SBPME	1,000	2" premium locking casters	standard metal	
custom lower height X (specify height)	22 x 22 24 x 24, 30 rd	22 x 22 24 x 24, 30 rd	1	BXMOT24024SHGME	750	adj glides	standard metal	
		26 x 26 30 x 30, 36 rd	1	BXMOT30030SHGME	790	adj glides	standard metal	
		32 x 32 36 x 36, 42 rd	1	BXMOT36036SHGME	850	adj glides	standard metal	
		36 x 36 42 x 42, 48 rd	1	BXMOT42042SHGME	870	adj glides	standard metal	
	22 x 22 24 x 24, 30 rd	22 x 22 24 x 24, 30 rd	1	BXMOT24024SHCME	840	2" black locking casters	standard metal	
		26 x 26 30 x 30, 36 rd	1	BXMOT30030SHCME	880	2" black locking casters	standard metal	
		32 x 32 36 x 36, 42 rd	1	BXMOT36036SHCME	940	2" black locking casters	standard metal	
		36 x 36 42 x 42, 48 rd	1	BXMOT42042SHCME	960	2" black locking casters	standard metal	
	22 x 22 24 x 24, 30 rd	22 x 22 24 x 24, 30 rd	1	BXMOT24024SHPME	880	2" premium locking casters	standard metal	
		26 x 26 30 x 30, 36 rd	1	BXMOT30030SHPME	920	2" premium locking casters	standard metal	
		32 x 32 36 x 36, 42 rd	1	BXMOT36036SHPME	980	2" premium locking casters	standard metal	
		36 x 36 42 x 42, 48 rd	1	BXMOT42042SHPME	1,000	2" premium locking casters	standard metal	
27.75"H offset X	22 x 22 24 x 24, 30 rd	22 x 22 24 x 24, 30 rd	1	BXMOT24024SLGME	750	adj glides	standard metal	
		26 x 26 30 x 30, 36 rd	1	BXMOT30030SLGME	790	adj glides	standard metal	
		32 x 32 36 x 36, 42 rd	1	BXMOT36036SLGME	850	adj glides	standard metal	
		36 x 36 42 x 42, 48 rd	1	BXMOT42042SLGME	870	adj glides	standard metal	
	22 x 22 24 x 24, 30 rd	22 x 22 24 x 24, 30 rd	1	BXMOT24024SLCME	840	2" black locking casters	standard metal	
		26 x 26 30 x 30, 36 rd	1	BXMOT30030SLCME	880	2" black locking casters	standard metal	
		32 x 32 36 x 36, 42 rd	1	BXMOT36036SLCME	940	2" black locking casters	standard metal	
		36 x 36 42 x 42, 48 rd	1	BXMOT42042SLCME	960	2" black locking casters	standard metal	
	22 x 22 24 x 24, 30 rd	22 x 22 24 x 24, 30 rd	1	BXMOT24024SLPME	880	2" premium locking casters	standard metal	
		26 x 26 30 x 30, 36 rd	1	BXMOT30030SLPME	920	2" premium locking casters	standard metal	
		32 x 32 36 x 36, 42 rd	1	BXMOT36036SLPME	980	2" premium locking casters	standard metal	
		36 x 36 42 x 42, 48 rd	1	BXMOT42042SLPME	1,000	2" premium locking casters	standard metal	



**Casters (C)**  
2" black dual wheel locking

**Standard metal powder coat finishes (ME)**  
Black Wrinkle, Chateau Brown Wrinkle, Flat Black, Furniture White, Inner Tone, Light Tone, Medium Tone and Metallic Silver



**Premium Casters (E)**  
2" silver/black dual wheel locking

# bases

## X and Y fixed

### Zoey

base	base dim.	max top support	base qty	base model no.	list	glides or casters	finish	
Zoey 	27.75"H X	21 x 21 24 x 24, 24 rd	1	BXZOE24024SDGME	620	adj glides	standard metal	
		27 x 27 30 x 30, 36 rd	1	BXZOE30030SDGME	650	adj glides	standard metal	
		33 x 33 36 x 36, 42 rd	1	BXZOE36036SDGME	690	adj glides	standard metal	
	40.75"H X	21 x 21 24 x 24, 24 rd	21 x 21 24 x 24, 24 rd	1	BXZOE24024SDCME	700	3" black locking casters	standard metal
			27 x 27 30 x 30, 36 rd	1	BXZOE30030SDCME	740	3" black locking casters	standard metal
			33 x 33 36 x 36, 42 rd	1	BXZOE36036SDCME	780	3" black locking casters	standard metal
		21 x 21 24 x 24, 24 rd	21 x 21 24 x 24, 24 rd	1	BXZOE24024SDPME	750	3" premium locking casters	standard metal
			27 x 27 30 x 30, 36 rd	1	BXZOE30030SDPME	780	3" premium locking casters	standard metal
			33 x 33 36 x 36, 42 rd	1	BXZOE36036SDPME	830	3" premium locking casters	standard metal
		21 x 21 24 x 24, 24 rd	21 x 21 24 x 24, 24 rd	1	BXZOE24024SBGME	700	adj glides	standard metal
			27 x 27 30 x 30, 36 rd	1	BXZOE30030SBGME	740	adj glides	standard metal
			33 x 33 36 x 36, 42 rd	1	BXZOE36036SBGME	780	adj glides	standard metal
21 x 21 24 x 24, 24 rd		21 x 21 24 x 24, 24 rd	1	BXZOE24024SBCME	790	3" black locking casters	standard metal	
		27 x 27 30 x 30, 36 rd	1	BXZOE30030SBCME	830	3" black locking casters	standard metal	
		33 x 33 36 x 36, 42 rd	1	BXZOE36036SBCME	870	3" black locking casters	standard metal	
21 x 21 24 x 24, 24 rd	21 x 21 24 x 24, 24 rd	1	BXZOE24024SBPME	840	3" premium locking casters	standard metal		
	27 x 27 30 x 30, 36 rd	1	BXZOE30030SBPME	870	3" premium locking casters	standard metal		
	33 x 33 36 x 36, 42 rd	1	BXZOE36036SBPME	910	3" premium locking casters	standard metal		

For complete custom lower height or custom higher height base model number:

1. Insert height selection:

**SH** custom Higher fixed height - specify height

**SL** custom Lower fixed height - specify height

custom height X	21 x 21 24 x 24, 24 rd	1	BXZOE24024__GME	700	adj glides	standard metal
	27 x 27 30 x 30, 36 rd	1	BXZOE30030__GME	740	adj glides	standard metal
	33 x 33 36 x 36, 42 rd	1	BXZOE36036__GME	780	adj glides	standard metal
27.75"H offset X	21 x 21 24 x 24, 24 rd	1	BXZOE24024__CME	790	3" black locking casters	standard metal
	27 x 27 30 x 30, 36 rd	1	BXZOE30030__CME	830	3" black locking casters	standard metal
	33 x 33 36 x 36, 42 rd	1	BXZOE36036__CME	870	3" black locking casters	standard metal
27.75"H offset X	21 x 21 24 x 24, 24 rd	1	BXZOE24024__PME	840	3" premium locking casters	standard metal
	27 x 27 30 x 30, 36 rd	1	BXZOE30030__PME	870	3" premium locking casters	standard metal
	33 x 33 36 x 36, 42 rd	1	BXZOE36036__PME	910	3" premium locking casters	standard metal
27.75"H offset X	21 x 27 24 x 30	1	BXZOE24030SDGME	550	adj glides	standard metal
	27 x 33 30 x 36	1	BXZOE30036SDGME	560	adj glides	standard metal
	21 x 27 24 x 30	1	BXZOE24030SDCME	640	3" black locking casters	standard metal
27.75"H offset X	27 x 33 30 x 36	1	BXZOE30036SDCME	650	3" black locking casters	standard metal
	21 x 27 24 x 30	1	BXZOE24030SDPME	680	3" premium locking casters	standard metal
	27 x 33 30 x 36	1	BXZOE30036SDPME	690	3" premium locking casters	standard metal



**Casters (C)**  
3" black dual wheel locking





**Standard metal powder coat finishes (ME)**  
Black Wrinkle, Chateau Brown Wrinkle, Flat Black, Furniture White, Inner Tone, Light Tone, Medium Tone and Metallic Silver







**Premium Casters (E)**  
3" white dual wheel locking



bases  
X and Y flip  
Keller, Ria

base	base dim.	max top support	base qty	base model no.	list	glides or casters	finish		
Keller 	flip X	20 x 20	24 x 24, 24 rd	1	BXKEL24024FDGME	790	adj glides	standard metal	
		26 x 26	30 x 30, 36 rd	1	BXKEL30030FDGME	860	adj glides	standard metal	
		33 x 33	36 x 36, 42 rd	1	BXKEL36036FDGME	890	adj glides	standard metal	
		38 x 38	42 x 42, 48 rd	1	BXKEL42042FDGME	1,030	adj glides	standard metal	
	20 x 20	24 x 24, 24 rd	1	BXKEL24024FDCME	880	2" black locking casters	standard metal		
	26 x 26	30 x 30, 36 rd	1	BXKEL30030FDCME	950	2" black locking casters	standard metal		
	33 x 33	36 x 36, 42 rd	1	BXKEL36036FDCME	980	2" black locking casters	standard metal		
	38 x 38	42 x 42, 48 rd	1	BXKEL42042FDCME	1,120	2" black locking casters	standard metal		
	20 x 20	24 x 24, 24 rd	1	BXKEL24024FDGPO	880	adj glides	polished		
	26 x 26	30 x 30, 36 rd	1	BXKEL30030FDGPO	950	adj glides	polished		
	33 x 33	36 x 36, 42 rd	1	BXKEL36036FDGPO	980	adj glides	polished		
	38 x 38	42 x 42, 48 rd	1	BXKEL42042FDGPO	1,120	adj glides	polished		
	20 x 20	24 x 24, 24 rd	1	BXKEL24024FDCPO	1,010	2" black locking casters	polished		
	26 x 26	30 x 30, 36 rd	1	BXKEL30030FDCPO	1,080	2" black locking casters	polished		
	33 x 33	36 x 36, 42 rd	1	BXKEL36036FDCPO	1,110	2" black locking casters	polished		
	38 x 38	42 x 42, 48 rd	1	BXKEL42042FDCPO	1,250	2" black locking casters	polished		
Ria 	flip Y	20 x 20	24 x 24, 24 rd	1	BYKEL24024FDGME	760	adj glides	standard metal	
		26 x 26	30 x 30, 30 rd	1	BYKEL30030FDGME	780	adj glides	standard metal	
		33 x 33	36 x 36, 36 rd	1	BYKEL36036FDGME	850	adj glides	standard metal	
		20 x 20	24 x 24, 24 rd	1	BYKEL24024FDCME	850	2" black locking casters	standard metal	
	26 x 26	30 x 30, 30 rd	1	BYKEL30030FDCME	870	2" black locking casters	standard metal		
	33 x 33	36 x 36, 36 rd	1	BYKEL36036FDCME	940	2" black locking casters	standard metal		
	20 x 20	24 x 24, 24 rd	1	BYKEL24024FDGPO	850	adj glides	polished		
	26 x 26	30 x 30, 30 rd	1	BYKEL30030FDGPO	870	adj glides	polished		
	33 x 33	36 x 36, 36 rd	1	BYKEL36036FDGPO	940	adj glides	polished		
	20 x 20	24 x 24, 24 rd	1	BYKEL24024FDCPO	940	2" black locking casters	polished		
	26 x 26	30 x 30, 30 rd	1	BYKEL30030FDCPO	960	2" black locking casters	polished		
	33 x 33	36 x 36, 36 rd	1	BYKEL36036FDCPO	1,020	2" black locking casters	polished		
	Ria 	flip X	20 x 20	24 x 24, 24 rd	1	BXRIA24024FDGME	690	adj glides	standard metal
			26 x 26	30 x 30, 36 rd	1	BXRIA30030FDGME	770	adj glides	standard metal
			33 x 33	36 x 36, 42 rd	1	BXRIA36036FDGME	860	adj glides	standard metal
			38 x 38	42 x 42, 48 rd	1	BXRIA42042FDGME	960	adj glides	standard metal
20 x 20		24 x 24, 24 rd	1	BXRIA24024FDCME	780	2" black locking casters	standard metal		
26 x 26		30 x 30, 36 rd	1	BXRIA30030FDCME	860	2" black locking casters	standard metal		
33 x 33		36 x 36, 42 rd	1	BXRIA36036FDCME	950	2" black locking casters	standard metal		
38 x 38		42 x 42, 48 rd	1	BXRIA42042FDCME	1,050	2" black locking casters	standard metal		
20 x 20		24 x 24, 24 rd	1	BXRIA24024FDGPO	780	adj glides	polished		
26 x 26		30 x 30, 36 rd	1	BXRIA30030FDGPO	860	adj glides	polished		
33 x 33		36 x 36, 42 rd	1	BXRIA36036FDGPO	950	adj glides	polished		
38 x 38		42 x 42, 48 rd	1	BXRIA42042FDGPO	1,050	adj glides	polished		
20 x 20		24 x 24, 24 rd	1	BXRIA24024FDCPO	870	2" black locking casters	polished		
26 x 26		30 x 30, 36 rd	1	BXRIA30030FDCPO	950	2" black locking casters	polished		
33 x 33		36 x 36, 42 rd	1	BXRIA36036FDCPO	1,030	2" black locking casters	polished		
38 x 38		42 x 42, 48 rd	1	BXRIA42042FDCPO	1,130	2" black locking casters	polished		
Ria 		flip Y	20 x 20	24 x 24, 24 rd	1	BYRIA24024FDGME	680	adj glides	standard metal
			26 x 26	30 x 30, 30 rd	1	BYRIA30030FDGME	720	adj glides	standard metal
			33 x 33	36 x 36, 36 rd	1	BYRIA36036FDGME	760	adj glides	standard metal
			20 x 20	24 x 24, 24 rd	1	BYRIA24024FDCME	770	2" black locking casters	standard metal
	26 x 26	30 x 30, 30 rd	1	BYRIA30030FDCME	800	2" black locking casters	standard metal		
	33 x 33	36 x 36, 36 rd	1	BYRIA36036FDCME	850	2" black locking casters	standard metal		
	20 x 20	24 x 24, 24 rd	1	BYRIA24024FDGPO	770	adj glides	polished		
	26 x 26	30 x 30, 30 rd	1	BYRIA30030FDGPO	800	adj glides	polished		
33 x 33	36 x 36, 36 rd	1	BYRIA36036FDGPO	850	adj glides	polished			
20 x 20	24 x 24, 24 rd	1	BYRIA24024FDCPO	860	2" black locking casters	polished			
26 x 26	30 x 30, 30 rd	1	BYRIA30030FDCPO	890	2" black locking casters	polished			
33 x 33	36 x 36, 36 rd	1	BYRIA36036FDCPO	940	2" black locking casters	polished			

bases  
X and Y flip  
Ria nesting, Novi, Rosanno

base	base dim.	max top support	base qty	base model no.	list	glides or casters	finish	
Ria 	nesting flip X	20 x 20	24 x 24, 24 rd	1	BXRIA24024NEGME	920	adj glides	standard metal
		26 x 26	30 x 30, 30 rd	1	BXRIA30030NEGME	990	adj glides	standard metal
		33 x 33	36 x 36, 36 rd	1	BXRIA36036NEGME	1,050	adj glides	standard metal
		38 x 38	42 rd only	1	BXRIA42000NEGME	1,060	adj glides	standard metal
	20 x 20	24 x 24, 24 rd	1	BXRIA24024NECME	1,010	2" black locking casters	standard metal	
	26 x 26	30 x 30, 30 rd	1	BXRIA30030NECME	1,080	2" black locking casters	standard metal	
	33 x 33	36 x 36, 36 rd	1	BXRIA36036NECME	1,130	2" black locking casters	standard metal	
	33 x 33	42 rd only	1	BXRIA42000NECME	1,140	2" black locking casters	standard metal	
	20 x 20	24 x 24, 24 rd	1	BXRIA24024NEGPO	1,010	adj glides	polished	
	26 x 26	30 x 30, 30 rd	1	BXRIA30030NEGPO	1,080	adj glides	polished	
	33 x 33	36 x 36, 36 rd	1	BXRIA36036NEGPO	1,130	adj glides	polished	
	33 x 33	42 rd only	1	BXRIA42000NEGPO	1,140	adj glides	polished	
	20 x 20	24 x 24, 24 rd	1	BXRIA24024NECPO	1,100	2" black locking casters	polished	
	26 x 26	30 x 30, 30 rd	1	BXRIA30030NECPO	1,170	2" black locking casters	polished	
	33 x 33	36 x 36, 36 rd	1	BXRIA36036NECPO	1,220	2" black locking casters	polished	
	33 x 33	42 rd only	1	BXRIA42000NECPO	1,230	2" black locking casters	polished	
Ria 	nesting flip offset X	20 x 26	24 x 30	1	BXRIA24030NEGME	980	adj glides	standard metal
		20 x 33	24 x 36	1	BXRIA24036NEGME	1,030	adj glides	standard metal
		20 x 38	24 x 42	1	BXRIA24042NEGME	1,120	adj glides	standard metal
		20 x 26	24 x 30	1	BXRIA24030NECME	1,070	2" black locking casters	standard metal
	20 x 33	24 x 36	1	BXRIA24036NECME	1,120	2" black locking casters	standard metal	
	20 x 38	24 x 42	1	BXRIA24042NECME	1,210	2" black locking casters	standard metal	
	20 x 26	24 x 30	1	BXRIA24030NEGPO	1,070	adj glides	polished	
	20 x 33	24 x 36	1	BXRIA24036NEGPO	1,120	adj glides	polished	
	20 x 38	24 x 42	1	BXRIA24042NEGPO	1,210	adj glides	polished	
	20 x 26	24 x 30	1	BXRIA24030NECPO	1,160	2" black locking casters	polished	
	20 x 33	24 x 36	1	BXRIA24036NECPO	1,210	2" black locking casters	polished	
	20 x 38	24 x 42	1	BXRIA24042NECPO	1,300	2" black locking casters	polished	
Novi 	flip X	22 x 22	24 x 24, 24 rd	1	BXNOV24024FDGME	770	adj glides	standard metal
		26 x 26	30 x 30, 36 rd	1	BXNOV30030FDGME	830	adj glides	standard metal
		32 x 32	36 x 36, 42 rd	1	BXNOV36036FDGME	900	adj glides	standard metal
		22 x 22	24 x 24, 24 rd	1	BXNOV24024FDCME	860	2" black locking casters	standard metal
	26 x 26	30 x 30, 36 rd	1	BXNOV30030FDCME	910	2" black locking casters	standard metal	
	32 x 32	36 x 36, 42 rd	1	BXNOV36036FDCME	990	2" black locking casters	standard metal	
	22 x 22	24 x 24, 24 rd	1	BXNOV24024FDGPO	990	adj glides	polished	
	26 x 26	30 x 30, 36 rd	1	BXNOV30030FDGPO	1,050	adj glides	polished	
	32 x 32	36 x 36, 42 rd	1	BXNOV36036FDGPO	1,120	adj glides	polished	
	22 x 22	24 x 24, 24 rd	1	BXNOV24024FDCPC	1,080	2" black locking casters	polished	
	26 x 26	30 x 30, 36 rd	1	BXNOV30030FDCPC	1,130	2" black locking casters	polished	
	32 x 32	36 x 36, 42 rd	1	BXNOV36036FDCPC	1,210	2" black locking casters	polished	
Rosanno 	flip X	26 x 26	30 x 30, 36 rd	1	BXROS30030FDGME	910	adj glides	standard metal
		32 x 32	36 x 36, 42 rd	1	BXROS36036FDGME	990	adj glides	standard metal
		38 x 38	42 x 42, 48 rd*	1	BXROS42042FDGME	1,070	adj glides	standard metal
		26 x 26	30 x 30, 36 rd	1	BXROS30030FDCME	1,000	2" black locking casters	standard metal
	32 x 32	36 x 36, 42 rd	1	BXROS36036FDCME	1,080	2" black locking casters	standard metal	
	26 x 26	30 x 30, 36 rd	1	BXROS30030FDGPO	1,130	adj glides	polished	
	32 x 32	36 x 36, 42 rd	1	BXROS36036FDGPO	1,210	adj glides	polished	
	38 x 38	42 x 42, 48 rd*	1	BXROS42042FDGPO	1,290	adj glides	polished	
	26 x 26	30 x 30, 36 rd	1	BXROS30030FDCPC	1,220	2" black locking casters	polished	
	32 x 32	36 x 36, 42 rd	1	BXROS36036FDCPC	1,300	2" black locking casters	polished	



 **Casters (C):**  
2" black dual wheel locking

**Standard metal powder coat finishes (ME):**  
Black Wrinkle, Chateau Brown Wrinkle, Flat Black, Furniture White, Inner Tone, Light Tone, Medium Tone, and Metallic Silver

**Premium Polished Finishes:**  
PQ Polished Aluminum/steel (Keller + Ria)  
PC Polished Chrome (Novi + Rosanno)

# bases

X flip  
Moto, Zoey

base	base dim.	max top support	base qty	base model no.	list	glides or casters	finish
Moto 	flip X	22 x 22 24 x 24, 30 rd	1	BXMOT24024FDGME	920	adj glides	standard metal
		26 x 26 30 x 30, 36 rd	1	BXMOT30030FDGME	980	adj glides	standard metal
		32 x 32 36 x 36, 42 rd	1	BXMOT36036FDGME	1,020	adj glides	standard metal
		22 x 22 24 x 24, 30 rd	1	BXMOT24024FDCME	1,010	2" black locking casters	standard metal
		26 x 26 30 x 30, 36 rd	1	BXMOT30030FDCME	1,070	2" black locking casters	standard metal
		32 x 32 36 x 36, 42 rd	1	BXMOT36036FDCME	1,110	2" black locking casters	standard metal
		22 x 22 24 x 24, 30 rd	1	BXMOT24024FDPME	1,060	2" premium locking casters	standard metal
		26 x 26 30 x 30, 36 rd	1	BXMOT30030FDPME	1,110	2" premium locking casters	standard metal
		32 x 32 36 x 36, 42 rd	1	BXMOT36036FDPME	1,160	2" premium locking casters	standard metal
Zoey 	flip X	21 x 21 24 x 24, 24 rd	1	BXZOE24024FDGME	860	adj glides	standard metal
		27 x 27 30 x 30, 36 rd	1	BXZOE30030FDGME	870	adj glides	standard metal
		33 x 33 36 x 36, 42 rd	1	BXZOE36036FDGME	910	adj glides	standard metal
		21 x 21 24 x 24, 24 rd	1	BXZOE24024FDCME	860	3" black locking casters	standard metal
		27 x 27 30 x 30, 36 rd	1	BXZOE30030FDCME	870	3" black locking casters	standard metal
		33 x 33 36 x 36, 42 rd	1	BXZOE36036FDCME	910	3" black locking casters	standard metal
		21 x 21 24 x 24, 24 rd	1	BXZOE24024FDPME	900	3" premium locking casters	standard metal
		27 x 27 30 x 30, 36 rd	1	BXZOE30030FDPME	910	3" premium locking casters	standard metal
		33 x 33 36 x 36, 42 rd	1	BXZOE36036FDPME	960	3" premium locking casters	standard metal



**Casters (C):**  
2" black dual wheel locking (Keller, Ria, Novi, Moto)  
3" black dual wheel locking (Zoey)

**Premium Casters (P):**  
2" silver/black dual wheel locking (Moto)  
3" white/grey dual wheel locking (Zoey)

**Standard metal powder coat finishes (ME):**  
Black Wrinkle, Chateau Brown Wrinkle, Flat Black, Furniture White, Inner Tone, Light Tone, Medium Tone, and Metallic Silver

\*\* Note that the inner column of Moto height adjustable bases are only available in Flat Black, White or Metallic Silver. Note that Moto White is a shade off and a little creamier than Furniture White. The Moto Counter balance and Ratchet height adjustable bases inner and outer columns are only available in Flat Black, Moto White and Metallic Silver.

Height adjustable X base details and descriptions for bases on the next page:



**SS Spring clip height adjustment (Keller & Ria)**  
24.75" - 33.75" base height range with glides  
26.75" - 35.75" base height range with casters  
six heights in 1" increments



**SG Gas assisted spring clip height adjustment (Novi)**  
27.75" - 39.75" height range with glides or casters  
adjustable in 1" increments  
gas assisted spring allows adjustment of inner column  
inner column runs on roller bearings









**R Ratchet height adjustment (Moto)**  
26" - 35.5" base height range with glides  
28" - 37.5" base height range with casters  
13 positions in 0.78 inch increments  
change positions by manually lifting the table top  
resets to lowest position when lifted to upper stop

**C Crank adjustment (Moto)**  
base height range with glides 26" - 43.75"  
base height range with casters 28" - 45.75"  
-screw thread adjustment with infinite stop positions  
-adjust with manual crank handle which slides under table when not in use

**P Pneumatic counter balance (Moto)**  
base height range with glides 26" - 45.5"  
base height range with casters 28" - 47.5"  
-Must specify the weight of the top and all accessories that will be used on the bases so that the lift capacity can be set properly.



# bases

X and Y adjustable height  
Keller, Ria, Novi, Moto

base	base dim.	max top support	base qty	base model no.	list	glides or casters	finish	
Keller 	spring clip X	20 x 20 24 x 24, 24 rd	1	BXKEL24024SSGME	860	adj glides	standard metal	
		26 x 26 30 x 30, 36 rd	1	BXKEL30030SSGME	910	adj glides	standard metal	
		33 x 33 36 x 36, 42 rd	1	BXKEL36036SSGME	960	adj glides	standard metal	
	Y spring clip	20 x 20 24 x 24, 24 rd	1	BXKEL24024SSCME	950	2" black locking casters	standard metal	
		26 x 26 30 x 30, 36 rd	1	BXKEL30030SSCME	1,000	2" black locking casters	standard metal	
		33 x 33 36 x 36, 42 rd	1	BXKEL36036SSCME	1,050	2" black locking casters	standard metal	
	Novi 	Y spring clip	20 x 20 24 x 24, 24 rd	1	BYKEL24024SSGME	800	adj glides	standard metal
			26 x 26 30 x 30, 36 rd	1	BYKEL30030SSGME	850	adj glides	standard metal
			33 x 33 36 x 36, 36 rd	1	BYKEL36036SSGME	890	adj glides	standard metal
Ria 	spring clip X	20 x 20 24 x 24, 24 rd	1	BXRIA24024SSGME	890	2" black locking casters	standard metal	
		26 x 26 30 x 30, 36 rd	1	BXRIA30030SSCME	940	2" black locking casters	standard metal	
		33 x 33 36 x 36, 36 rd	1	BXRIA36036SSCME	980	2" black locking casters	standard metal	
	Y spring clip	20 x 20 24 x 24, 24 rd	1	BXRIA24024SSCME	850	2" black locking casters	standard metal	
		26 x 26 30 x 30, 36 rd	1	BXRIA30030SSCME	950	2" black locking casters	standard metal	
		33 x 33 36 x 36, 42 rd	1	BXRIA36036SSCME	990	2" black locking casters	standard metal	
	Novi 	Y spring clip	20 x 20 24 x 24, 24 rd	1	BYRIA24024SSGME	730	adj glides	standard metal
			26 x 26 30 x 30, 36 rd	1	BYRIA30030SSGME	760	adj glides	standard metal
			33 x 33 36 x 36, 36 rd	1	BYRIA36036SSGME	780	adj glides	standard metal
Novi 	gas assisted spring clip	20 x 20 24 x 24, 24 rd	1	BYRIA24024SSCME	810	2" black locking casters	standard metal	
		26 x 26 30 x 30, 36 rd	1	BYRIA30030SSCME	850	2" black locking casters	standard metal	
		33 x 33 36 x 36, 36 rd	1	BYRIA36036SSCME	870	2" black locking casters	standard metal	
	Moto 	ratchet X	22 x 22 24 x 24, 24 rd	1	BXNOV24024SSGME	1,090	adj glides	standard metal
			26 x 26 30 x 30, 36 rd	1	BXNOV30030SSGME	1,120	adj glides	standard metal
			32 x 32 36 x 36, 42 rd	1	BXNOV36036SSGME	1,170	adj glides	standard metal
			22 x 22 24 x 24, 24 rd	1	BXNOV24024SSCME	1,180	2" black locking casters	standard metal
			26 x 26 30 x 30, 36 rd	1	BXNOV30030SSCME	1,210	2" black locking casters	standard metal
			32 x 32 36 x 36, 42 rd	1	BXNOV36036SSCME	1,250	2" black locking casters	standard metal
Moto 	crank X	22 24 x 24, 30 rd	1	BXMOT24024SRGME	960	adj glides	standard metal	
		26 30 x 30, 36 rd	1	BXMOT30030SRGME	1,000	adj glides	standard metal	
		22 24 x 24, 30 rd	1	BXMOT24024SRCME	1,050	2" black locking casters	standard metal	
			26 30 x 30, 36 rd	1	BXMOT30030SRCME	1,090	2" black locking casters	standard metal
			22 24 x 24, 30 rd	1	BXMOT24024SRPME	1,090	2" premium locking casters	standard metal
			26 30 x 30, 36 rd	1	BXMOT30030SRPME	1,130	2" premium locking casters	standard metal
			22 24 x 24, 30 rd	1	BXMOT24024SCGME	1,100	adj glides	standard metal
			26 30 x 30, 36 rd	1	BXMOT30030SCGME	1,160	adj glides	standard metal
			22 24 x 24, 30 rd	1	BXMOT24024SCCME	1,190	2" black locking casters	standard metal
		26 30 x 30, 36 rd	1	BXMOT30030SCCME	1,240	2" black locking casters	standard metal	
		22 24 x 24, 30 rd	1	BXMOT24024SCPME	1,230	2" premium locking casters	standard metal	
		26 30 x 30, 36 rd	1	BXMOT30030SCPME	1,290	2" premium locking casters	standard metal	
Moto 	pneumatic counter balance X	22 x 22 24 x 24, 30 rd	1	BXMOT24024SPGME	1,310	adj glides	standard metal	
		26 x 26 30 x 30, 36 rd	1	BXMOT30030SPGME	1,350	adj glides	standard metal	
		32 x 32 36 x 36, 42 rd	1	BXMOT36036SPGME	1,390	adj glides	standard metal	
			36 x 36 42 x 42, 48 rd	1	BXMOT42042SPGME	1,430	adj glides	standard metal
			22 x 22 24 x 24, 30 rd	1	BXMOT24024SPCME	1,400	2" black locking casters	standard metal
			26 x 26 30 x 30, 36 rd	1	BXMOT30030SPCME	1,440	2" black locking casters	standard metal
			32 x 32 36 x 36, 42 rd	1	BXMOT36036SPCME	1,470	2" black locking casters	standard metal
			36 x 36 42 x 42, 48 rd	1	BXMOT42042SPCME	1,520	2" black locking casters	standard metal
			22 x 22 24 x 24, 30 rd	1	BXMOT24024SPPME	1,440	2" premium locking casters	standard metal
		26 x 26 30 x 30, 36 rd	1	BXMOT30030SPPME	1,490	2" premium locking casters	standard metal	
		32 x 32 36 x 36, 42 rd	1	BXMOT36036SPPME	1,520	2" premium locking casters	standard metal	
		36 x 36 42 x 42, 48 rd	1	BXMOT42042SPPME	1,560	2" premium locking casters	standard metal	



bases  
four column X  
Keller, Ria, Novi



base	base dim.	max top support	base qty	base model no.	list	glides or casters	finish		
Keller 	27.75"H	38 x 38 48 x 48, 54 rd	1	BXKEL480484DGME	1,440	adj glides	standard metal		
		46 x 46 54 x 54, 66 rd	1	BXKEL540544DGME	1,500	adj glides	standard metal		
	custom taller height (specify height)	38 x 38 48 x 48, 54 rd	46 x 46 54 x 54, 66 rd	1	BXKEL480484DCME	1,550	2" black locking casters	standard metal	
			46 x 46 54 x 54, 66 rd	1	BXKEL540544DCME	1,610	2" black locking casters	standard metal	
		46 x 46 54 x 54, 66 rd	38 x 38 48 x 48, 54 rd	1	BXKEL480484DGPO	1,770	adj glides	polished	
			46 x 46 54 x 54, 66 rd	1	BXKEL540544DGPO	1,830	adj glides	polished	
		38 x 38 48 x 48, 54 rd	46 x 46 54 x 54, 66 rd	1	BXKEL480484DCPO	1,880	2" black locking casters	polished	
			46 x 46 54 x 54, 66 rd	1	BXKEL540544DCPO	1,940	2" black locking casters	polished	
		Ria 	27.75"H	38 x 38 48 x 48, 60 rd	1	BXRIA480484DGME	1,290	adj glides	standard metal
				46 x 46 54 x 54, 66 rd	1	BXRIA540544DGME	1,340	adj glides	standard metal
58 x 58 60 x 60, 72 rd				1	BXRIA600604DGME	1,460	adj glides	standard metal	
custom taller height (specify height)			38 x 38 48 x 48, 60 rd	46 x 46 54 x 54, 66 rd	1	BXRIA480484DCME	1,400	2" black locking casters	standard metal
	46 x 46 54 x 54, 66 rd			1	BXRIA540544DCME	1,450	2" black locking casters	standard metal	
	58 x 58 60 x 60, 72 rd			1	BXRIA600604DCME	1,570	2" black locking casters	standard metal	
	46 x 46 54 x 54, 66 rd		38 x 38 48 x 48, 60 rd	1	BXRIA480484DGPO	1,620	adj glides	polished	
			46 x 46 54 x 54, 66 rd	1	BXRIA540544DGPO	1,670	adj glides	polished	
			58 x 58 60 x 60, 72 rd	1	BXRIA600604DGPO	1,790	adj glides	polished	
	38 x 38 48 x 48, 60 rd		46 x 46 54 x 54, 66 rd	1	BXRIA480484DCPO	1,730	2" black locking casters	polished	
		46 x 46 54 x 54, 66 rd	1	BXRIA540544DCPO	1,780	2" black locking casters	polished		
		58 x 58 60 x 60, 72 rd	1	BXRIA600604DCPO	1,900	2" black locking casters	polished		
		38 x 38 48 x 48, 60 rd	1	BXRIA480484HGME	1,640	adj glides	standard metal		
Novi 	27.75"H	46 x 46 54 x 54, 66 rd	1	BXRIA540544HGME	1,690	adj glides	standard metal		
		58 x 58 60 x 60, 72 rd	1	BXRIA600604HGME	1,820	adj glides	standard metal		
	custom taller height (specify height)	38 x 38 48 x 48, 60 rd	46 x 46 54 x 54, 66 rd	1	BXRIA480484HCME	1,750	2" black locking casters	standard metal	
			46 x 46 54 x 54, 66 rd	1	BXRIA540544HCME	1,800	2" black locking casters	standard metal	
		58 x 58 60 x 60, 72 rd	38 x 38 48 x 48, 60 rd	1	BXRIA600604HCME	1,930	2" black locking casters	standard metal	
			38 x 38 48 x 48, 60 rd	1	BXRIA480484HGPO	1,970	adj glides	polished	
		46 x 46 54 x 54, 66 rd	46 x 46 54 x 54, 66 rd	1	BXRIA540544HGPO	2,020	adj glides	polished	
			58 x 58 60 x 60, 72 rd	1	BXRIA600604HGPO	2,150	adj glides	polished	
		38 x 38 48 x 48, 60 rd	46 x 46 54 x 54, 66 rd	1	BXRIA480484HCPO	2,080	2" black locking casters	polished	
			46 x 46 54 x 54, 66 rd	1	BXRIA540544HCPO	2,130	2" black locking casters	polished	
58 x 58 60 x 60, 72 rd	36 x 36 54 x 54, 60 rd	1	BXRNOV540544DGME	950	adj glides	standard metal			
	36 x 36 54 x 54, 60 rd	1	BXRNOV540544DCME	1,060	2" black locking casters	standard metal			
36 x 36 54 x 54, 60 rd	36 x 36 54 x 54, 60 rd	1	BXRNOV540544HGME	1,400	adj glides	standard metal			
	36 x 36 54 x 54, 60 rd	1	BXRNOV540544HCME	1,510	2" black locking casters	standard metal			

 casters (C)  
2" black dual wheel locking

**Standard metal powder coat finishes (ME):**  
Black Wrinkle (BW), Chateau Brown Wrinkle (CB), Flat Black (FB), Furniture White (FW), Inner Tone (IT), Light Tone (LT), Medium Tone (MT), Metallic Silver (MS).

**Premium Polished Finishes:**  
PO Polished aluminum/steel (Ria + Keller)

bases  
four column X  
Rosanno, Zoey

base	base dim.	max top support	base qty	base model no.	list	glides or casters	finish
Rosanno 	27.75"H	36 x 36 48 x 48, 60 rd	1	BXR0S480484DGME	1,630	adj glides	standard metal
		36 x 36 48 x 48, 60 rd	1	BXR0S480484DCME	1,740	2" black locking casters	standard metal
	custom taller height (specify height)	36 x 36 48 x 48, 60 rd	1	BXR0S480484HGME	2,050	adj glides	standard metal
		36 x 36 48 x 48, 60 rd	1	BXR0S480484HCME	2,160	2" black locking casters	standard metal
Zoey 	27.75"H	31 x 31 42 x 42, 48 rd	1	BXZO248000RD4DGME	1,830	adj glides	standard metal
		35 x 35 54 rd	1	BXZO254000RD4DGME	1,850	adj glides	standard metal
	35 x 35 60 rd	31 x 31 42 x 42 sq	1	BXZO260000RD4DGME	1,870	adj glides	standard metal
		31 x 31 42 x 42 sq	1	BXZO242042SQ4DGME	1,820	adj glides	standard metal
	35 x 35 48 x 48 sq	40 x 40 54 x 54 sq	1	BXZO248048SQ4DGME	1,850	adj glides	standard metal
		40 x 40 54 x 54 sq	1	BXZO254054SQ4DGME	1,910	adj glides	standard metal
	44 x 44 60 x 60 sq	44 x 44 60 x 60 sq	1	BXZO260060SQ4DGME	1,960	adj glides	standard metal
		44 x 44 60 x 60 sq	1	BXZO260060SQ4DGME	1,960	adj glides	standard metal

 casters (C) (Rosanno)  
2" black dual wheel locking

**Standard metal powder coat finishes (ME):**  
Black Wrinkle (BW), Chateau Brown Wrinkle (CB), Flat Black (FB), Furniture White (FW), Inner Tone (IT), Light Tone (LT), Medium Tone (MT), Metallic Silver (MS).













# bases

## personal workstation

### Una fixed height wheel barrow

base	base dim.	max top support	base qty	base model no.	list	glides / casters	finish
<b>Una fixed height wheel barrow round column (27.75"H)</b>							
	H flip 18 x 30	24 x 36	1	BHUNAR2436FDHME	1,140	2 adj glides / 2 casters	standard metal
	H tilt 18 x 30	24 x 36	1	BHUNAR2436TDHME	1,180	2 adj glides / 2 casters	standard metal
	H fixed 18 x 30	24 x 36	1	BHUNAR2436SDHME	880	2 adj glides / 2 casters	standard metal
<b>Una fixed height wheel barrow round column (custom taller height - specify height)</b>							
	H flip 18 x 30	24 x 36	1	BHUNAR2436FHHME	1,240	2 adj glides / 2 casters	standard metal
	H tilt 18 x 30	24 x 36	1	BHUNAR2436THHME	1,280	2 adj glides / 2 casters	standard metal
	H fixed 18 x 30	24 x 36	1	BHUNAR2436SHHME	980	2 adj glides / 2 casters	standard metal
<b>Una fixed height wheel barrow round column (custom lower height - specify height*)</b> *20" minimum height with glides or 22" minimum height with casters							
	H flip 18 x 30	24 x 36	1	BHUNAR2436FLHME	1,240	2 adj glides / 2 casters	standard metal
	H tilt 18 x 30	24 x 36	1	BHUNAR2436TLHME	1,280	2 adj glides / 2 casters	standard metal
	H fixed 18 x 30	24 x 36	1	BHUNAR2436SLHME	980	2 adj glides / 2 casters	standard metal

\* top not included

**Standard metal powder coat finishes (ME):**

Black Wrinkle, Chateau Brown Wrinkle, Flat Black, Furniture White, Inner Tone, Light Tone, Medium Tone, and Metallic Silver









The Wheel Barrow base features 2 glides and 2 casters.



# bases

## personal workstation

### Una fixed height wheel barrow

base	base dim.	max top support	base qty	base model no.	list	glides or casters	finish
<b>Una fixed height wheel barrow square column (27.75"H)</b>							
	H flip 18 x 30	24 x 36	1	BHUNAS2436FDHME	1,140	2 adj glides / 2 casters	standard metal
	H tilt 18 x 30	24 x 36	1	BHUNAS2436TDHME	1,180	2 adj glides / 2 casters	standard metal
	H fixed 18 x 30	24 x 36	1	BHUNAS2436SDHME	880	2 adj glides / 2 casters	standard metal
<b>Una fixed height wheel barrow square column (custom taller height - specify height)</b>							
	H flip 18 x 30	24 x 36	1	BHUNAS2436FHHME	1,240	2 adj glides / 2 casters	standard metal
	H tilt 18 x 30	24 x 36	1	BHUNAS2436THHME	1,280	2 adj glides / 2 casters	standard metal
	H fixed 18 x 30	24 x 36	1	BHUNAS2436SHHME	980	2 adj glides / 2 casters	standard metal
<b>Una fixed height wheel barrow square column (custom lower height - specify height*)</b> *20" minimum height with glides or 22" minimum height with casters							
	H flip 18 x 30	24 x 36	1	BHUNAS2436FLHME	1,240	2 adj glides / 2 casters	standard metal
	H tilt 18 x 30	24 x 36	1	BHUNAS2436TLHME	1,280	2 adj glides / 2 casters	standard metal
	H fixed 18 x 30	24 x 36	1	BHUNAS2436SLHME	980	2 adj glides / 2 casters	standard metal

\* top not included

**Standard metal powder coat finishes (ME):**

Black Wrinkle, Chateau Brown Wrinkle, Flat Black, Furniture White, Inner Tone, Light Tone, Medium Tone, and Metallic Silver







The Wheel Barrow base features 2 glides and 2 casters..



# bases

## personal workstation

### Una adjustable height









base	base dim.	max top support	base qty	base model no.	list	glides or casters	finish	
<b>Una pneumatic height adj round column</b>								
	V flip	18 x 30	24 x 30	1	BVUNAR2430FPGME	1,680	adj glides	standard metal
		18 x 30	24 x 30	1	BVUNAR2430FPCME	1,770	2" black hard casters	standard metal
		18 x 30	24 x 30	1	BVUNAR2430FPSME	1,820	2" black soft casters	standard metal
		18 x 30	24 x 30	1	BVUNAR2430FPPME	1,820	2" premium hard casters	standard metal
Una V flip adj height range with glides is 29.07-46.7" without the top Una V flip adj height range with 2" locking casters is 31.07 - 48.7" without the top								
<b>Optional Drop Down Kit</b> (only for use with the 2" locking caster option) lowers the height range to 30.02" - 47.65" without the top <b>model number OBUNADROP \$60 list</b>								
	V tilt	18 x 30	24 x 30	1	BVUNAR2430TPGME	1,730	adj glides	standard metal
		18 x 30	24 x 30	1	BVUNAR2430TPCME	1,820	2" black hard casters	standard metal
		18 x 30	24 x 30	1	BVUNAR2430TPSME	1,860	2" black soft casters	standard metal
		18 x 30	24 x 30	1	BVUNAR2430TPPME	1,860	2" premium hard casters	standard metal
Una V tilt adj height range with glides is 29.07-46.7" without the top Una V tilt adj height range with 2" locking casters is 31.07 - 48.7" without the top								
<b>Optional Drop Down Kit</b> (only for use with the 2" locking caster option) lowers the height range to 30.02" - 47.65" without the top								
	V fixed	18 x 30	24 x 30	1	BVUNAR2430SPGME	1,530	adj glides	standard metal
		18 x 30	24 x 30	1	BVUNAR2430SPCME	1,620	2" black hard casters	standard metal
		18 x 30	24 x 30	1	BVUNAR2430SPSME	1,660	2" black soft casters	standard metal
		18 x 30	24 x 30	1	BVUNAR2430SPPME	1,660	2" premium hard casters	standard metal
Una V adj height range with glides is 26.01-43.73" without the top Una V adj height range with 2" locking casters is 28.5 - 46.13" without the top								
<b>Optional Drop Down Kit</b> (only for use with the 2" locking caster option) lowers the height range to 27.14" - 44.17" without the top								
	H flip	18 x 30	24 x 36	1	BHUNAR2436FPGME	1,680	adj glides	standard metal
		18 x 30	24 x 36	1	BHUNAR2436FPCME	1,770	2" black hard casters	standard metal
		18 x 30	24 x 36	1	BHUNAR2436FPSME	1,820	2" black soft casters	standard metal
		18 x 30	24 x 36	1	BHUNAR2436FPPME	1,820	2" premium hard casters	standard metal
Una H flip adj height range with glides is 28.89-46.52" without the top Una H flip adj height range with 2" locking casters is 31.29 - 48.92" without the top								
<b>Optional Drop Down Kit</b> (only for use with the 2" locking caster option) lowers the height range to 30.02" - 47.65" without the top <b>model number OBUNADROP \$60 list</b>								
	H tilt	18 x 30	24 x 36	1	BHUNAR2436TPGME	1,730	adj glides	standard metal
		18 x 30	24 x 36	1	BHUNAR2436TPCME	1,820	2" black hard casters	standard metal
		18 x 30	24 x 36	1	BHUNAR2436TPSME	1,860	2" black soft casters	standard metal
		18 x 30	24 x 36	1	BHUNAR2436TPPME	1,860	2" premium hard casters	standard metal
Una H tilt adj height range with glides is 31.29-46.52" without the top Una H tilt adj height range with 2" locking casters is 31.29 - 48.92" without the top								
<b>Optional Drop Down Kit</b> (only for use with the 2" locking caster option) lowers the height range to 30.02" - 47.65" without the top								
	H fixed	18 x 30	24 x 36	1	BHUNAR2436SPGME	#REF!	adj glides	standard metal
		18 x 30	24 x 36	1	BHUNAR2436SPCME	#REF!	2" black hard casters	standard metal
		18 x 30	24 x 36	1	BHUNAR2436SPSME	#REF!	2" black soft casters	standard metal
		18 x 30	24 x 36	1	BHUNAR2436SPPME	#REF!	2" premium hard casters	standard metal
Una H adj height range with glides is 26.1-43.73" without the top Una H adj height range with 2" locking casters is 28.5 - 46.13" without the top								
<b>Optional Drop Down Kit</b> (only for use with the 2" locking caster option) lowers the height range to 27.14" - 44.77" without the top								

\*top not included

# bases

## personal workstation

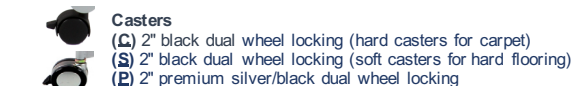

### Una adjustable height

base	base dim.	max top support	base qty	base model no.	list	glides or casters	finish	
<b>Una pneumatic height adj square column</b>								
	V fixed	18 x 30	24 x 30	1	BVUNAS2430SPGME	1,610	adj glides	standard metal
		18 x 30	24 x 30	1	BVUNAS2430SPCME	1,690	2" black hard casters	standard metal
		18 x 30	24 x 30	1	BVUNAS2430SPSME	1,740	2" black soft casters	standard metal
		18 x 30	24 x 30	1	BVUNAS2430SPPME	1,740	2" premium hard casters	standard metal
Una V adj height range with glides is 26-43.63" without the top Una V adj height range with 2" locking casters is 28.4 - 46.03" without the top								
<b>Optional Drop Down Kit</b> (only for use with the 2" locking caster option) lowers the height range to 27.13" - 44.76" without the top <b>model number OBUNADROP \$60 list</b>								
	H fixed	18 x 30	24 x 36	1	BHUNAS2436SPGME	1,610	adj glides	standard metal
		18 x 30	24 x 36	1	BHUNAS2436SPCME	1,690	2" black hard casters	standard metal
		18 x 30	24 x 36	1	BHUNAS2436SPSME	1,740	2" black soft casters	standard metal
		18 x 30	24 x 36	1	BHUNAS2436SPPME	1,740	2" premium hard casters	standard metal
Una H adj height range with glides is 26-43.63" without the top Una H adj height range with 2" locking casters is 28.4 - 46.03" without the top								
<b>Optional Drop Down Kit</b> (only for use with the 2" locking caster option) lowers the height range to 27.14" - 44.77" without the top <b>model number OBUNADROP \$60 list</b>								
<b>Una wheel barrow pneumatic height adj round column</b>								
	H flip	18 x 30	24 x 36	1	BVUNAR2436FPHME	1,790	2 adj glides / 2 casters	standard metal
		height range: 29.51" - 47.14" without the top						
	H tilt	18 x 30	24 x 36	1	BVUNAR2436TPHME	1,830	2 adj glides / 2 casters	standard metal
		height range: 29.51" - 47.14" without the top						
	H fixed	18 x 30	24 x 36	1	BVUNAR2436SPHME	1,640	2 adj glides / 2 casters	standard metal
		height range: 26.43" - 44.27" without the top						
<b>Una wheel barrow pneumatic height adj square column</b>								
	H fixed	18 x 30	24 x 36	1	BHUNAS2436SPHME	1,690	2 adj glides / 2 casters	standard metal
		height range: 26.63" - 44.26" without the top						
 <b>Casters</b> (C) 2" black dual wheel locking (hard casters for carpet) (S) 2" black dual wheel locking (soft casters for hard flooring) (E) 2" premium silver/black dual wheel locking								
 <b>The Wheel Barrow base features 2 casters and 2 glides</b>								
<b>Standard metal powder coat finishes for Una adjustable height bases (ME):</b> Flat Black (FB), Furniture White (FW), Metallic Silver (MS).								
Note that at least 24 x 30 top size is recommended for the <u>Una series bases</u> because the weight of the top is 22 lbs. This base has a lift range from 22 lbs to 44 lbs (including the top). If the accessories or items that will be placed on the base weigh over 22 lbs then please email <a href="mailto:service@symphontables.com">service@symphontables.com</a> for assistance.								
Additionally, if a smaller wksurface than 24 x 30 is required then please email <a href="mailto:service@symphonytable.com">service@symphonytable.com</a> for assistance to review options on how to add weight to a smaller top to meet hte 22 lb minimum requirement.								
The weight of the top and all accessories that will be used on the base shall be advised on the purchase order. If the weight is set wrong then it will cause the table to lift up to fast or not work at all. Contact <a href="mailto:service@symphonytables.com">service@symphonytables.com</a> for assistance.								



# bases

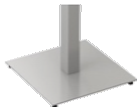
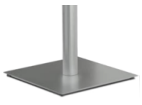

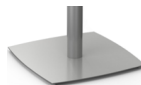
fixed height disc  
Bennett, Marius, Molly

base	base dim.	column	max top support	base model no.	list	glides	finish	
Bennett (square column) 	27.75"H	16 x 16	3" sq	30 x 30, 36 rd	BDBEN30030SDGME	780	adj glides	standard metal
		20 x 20	3" sq	36 x 36, 42 rd	BDBEN36036SDGME	860	adj glides	standard metal
		26 x 26	3" sq	42 x 42, 48 rd	BDBEN42042SDGME	1,030	adj glides	standard metal
	40.75"H	16 x 16	3" sq	30 x 30, 36 rd	BDBEN30030SBGME	870	adj glides	standard metal
		20 x 20	3" sq	36 x 36, 42 rd	BDBEN36036SBGME	950	adj glides	standard metal
		26 x 26	3" sq	42 x 42, 48 rd	BDBEN42042SBGME	1,120	adj glides	standard metal
	custom higher height (specify height)	16 x 16	3" sq	30 x 30, 36 rd	BDBEN30030SHGME	870	adj glides	standard metal
		20 x 20	3" sq	36 x 36, 42 rd	BDBEN36036SHGME	950	adj glides	standard metal
		26 x 26	3" sq	42 x 42, 48 rd	BDBEN42042SHGME	1,120	adj glides	standard metal
custom lower height (specify height)	16 x 16	3" sq	30 x 30, 36 rd	BDBEN30030SLGME	870	adj glides	standard metal	
	20 x 20	3" sq	36 x 36, 42 rd	BDBEN36036SLGME	950	adj glides	standard metal	
	26 x 26	3" sq	42 x 42, 48 rd	BDBEN42042SLGME	1,120	adj glides	standard metal	
Marius square disc. (round column) 	27.75"H	16 x 16	3" rd	30 x 30, 36 rd	BDMAR30030SDGME	780	adj glides	standard metal
		20 x 20	4" rd	36 x 36, 42 rd	BDMAR36036SDGME	860	adj glides	standard metal
		26 x 26	4" rd	42 x 42, 48 rd	BDMAR42042SDGME	1,030	adj glides	standard metal
		24 x 24	6" rd	48 x 48, 48 rd	BDMAR48048SDGME	1,390	adj glides	standard metal
	40.75"H	16 x 16	3" rd	30 x 30, 36 rd	BDMAR30030SBGME	910	adj glides	standard metal
		20 x 20	4" rd	36 x 36, 42 rd	BDMAR36036SBGME	990	adj glides	standard metal
		26 x 26	4" rd	42 x 42, 48 rd	BDMAR42042SBGME	1,170	adj glides	standard metal
		24 x 24	6" rd	48 x 48, 48 rd	BDMAR48048SBGME	1,520	adj glides	standard metal
	custom higher height (specify height)	16 x 16	3" rd	30 x 30, 36 rd	BDMAR30030SHGME	910	adj glides	standard metal
		20 x 20	4" rd	36 x 36, 42 rd	BDMAR36036SHGME	990	adj glides	standard metal
		26 x 26	4" rd	42 x 42, 48 rd	BDMAR42042SHGME	1,170	adj glides	standard metal
		24 x 24	6" rd	48 x 48, 48 rd	BDMAR48048SHGME	1,520	adj glides	standard metal
custom lower height (specify height)	16 x 16	3" rd	30 x 30, 36 rd	BDMAR30030SLGME	910	adj glides	standard metal	
	20 x 20	4" rd	36 x 36, 42 rd	BDMAR36036SLGME	990	adj glides	standard metal	
	26 x 26	4" rd	42 x 42, 48 rd	BDMAR42042SLGME	1,170	adj glides	standard metal	
	24 x 24	6" rd	48 x 48, 48 rd	BDMAR48048SLGME	1,520	adj glides	standard metal	
Marius rectangle disc (round column) 	27.75"H	18 x 28	6" rd	36 x 60	BDMAR36060SDGME	1,430	adj glides	standard metal
		26 x 30	6" rd	42 x 60	BDMAR42060SDGME	1,460	adj glides	standard metal
	40.75"H	18 x 28	6" rd	36 x 60	BDMAR36060SBGME	1,940	adj glides	standard metal
		26 x 30	6" rd	42 x 60	BDMAR42060SBGME	2,100	adj glides	standard metal
	custom higher height (specify height)	18 x 28	6" rd	36 x 60	BDMAR36060SHGME	1,940	adj glides	standard metal
		24 x 28	6" rd	42 x 60	BDMAR42060SHGME	2,100	adj glides	standard metal
custom lower height (specify height)	18 x 28	6" rd	36 x 60	BDMAR36060SLGME	1,560	adj glides	standard metal	
	26 x 30	6" rd	42 x 60	BDMAR42060SLGME	1,600	adj glides	standard metal	
Molly (round column) 	27.75"H	16 x 16	3" rd	30 x 30, 36 rd	BDMOL30030SDGME	780	adj glides	standard metal
		20 x 20	4" rd	36 x 36, 42 rd	BDMOL36036SDGME	860	adj glides	standard metal
		26 x 26	4" rd	42 x 42, 48 rd	BDMOL42042SDGME	1,030	adj glides	standard metal
	40.75"H	16 x 16	3" rd	30 x 30, 36 rd	BDMOL30030SBGME	870	adj glides	standard metal
		20 x 20	4" rd	36 x 36, 42 rd	BDMOL36036SBGME	950	adj glides	standard metal
		26 x 26	4" rd	42 x 42, 48 rd	BDMOL42042SBGME	1,120	adj glides	standard metal
	custom higher height (specify height)	16 x 16	3" rd	30 x 30, 36 rd	BDMOL30030SHGME	870	adj glides	standard metal
		20 x 20	4" rd	36 x 36, 42 rd	BDMOL36036SHGME	950	adj glides	standard metal
		26 x 26	4" rd	42 x 42, 48 rd	BDMOL42042SHGME	1,120	adj glides	standard metal
	custom lower height (specify height)	16 x 16	3" rd	30 x 30, 36 rd	BDMOL30030SLGME	870	adj glides	standard metal
		20 x 20	4" rd	36 x 36, 42 rd	BDMOL36036SLGME	950	adj glides	standard metal
		26 x 26	4" rd	42 x 42, 48 rd	BDMOL42042SLGME	1,120	adj glides	standard metal

**Standard metal powder coat finishes (ME):**  
Black Wrinkle (BW), Chateau Brown Wrinkle (CB), Flat Black (FB),  
Furniture White (FW), Inner Tone (IT), Light Tone (LT), Medium Tone (MT),  
Metallic Silver (MS).

# bases

fixed height disc  
Nantes II, Nantes C, Tondo

base	base dim.	column	max top support	base model no.	list	glides	finish	
Nantes II round disc. (round column) 	27.75"H	20	3" rd	30 x 30, 36 rd	BDNA230030SDGME	780	adj glides	standard metal
		24	4" rd	36 x 36, 42 rd	BDNA236036SDGME	860	adj glides	standard metal
		32	4" rd	42 x 42, 48 rd	BDNA242042SDGME	1,030	adj glides	standard metal
	40.75"H	32*	6" rd	48 x 48, 60 rd	BDNA248048SDGME	1,780	adj glides	standard metal
		20	3" rd	30 x 30, 36 rd	BDNA230030SBGME	870	adj glides	standard metal
		24	4" rd	36 x 36, 42 rd	BDNA236036SBGME	950	adj glides	standard metal
	custom higher height (specify height)	32	4" rd	42 x 42, 48 rd	BDNA242042SBGME	1,120	adj glides	standard metal
		32*	6" rd	48 x 48, 60 rd	BDNA248048SBGME	1,870	adj glides	standard metal
	custom lower height (specify height)	20	3" rd	30 x 30, 36 rd	BDNA230030SHGME	870	adj glides	standard metal
		24	4" rd	36 x 36, 42 rd	BDNA236036SHGME	950	adj glides	standard metal
		32	4" rd	42 x 42, 48 rd	BDNA242042SHGME	1,120	adj glides	standard metal
		32*	6" rd	48 x 48, 60 rd	BDNA248048SHGME	1,870	adj glides	standard metal
Nantes C round disc. w/ cover (round column) 	27.75"H	20	3" rd	30 x 30, 36 rd	BDNAC30030SDGPC	1,620	adj glides	polished
		24	4" rd	36 x 36, 42 rd	BDNAC36036SDGPC	1,720	adj glides	polished
		32	4" rd	42 x 42, 48 rd	BDNAC42042SDGPC	1,980	adj glides	polished
		32	6" rd	48 x 48, 60 rd	BDNAC48048SDGPC	2,400	adj glides	polished
	40.75"H	20	3" rd	30 x 30, 36 rd	BDNAC30030SBGPC	1,710	adj glides	polished
		24	4" rd	36 x 36, 42 rd	BDNAC36036SBGPC	1,800	adj glides	polished
		32	4" rd	42 x 42, 48 rd	BDNAC42042SBGPC	2,070	adj glides	polished
		32	6" rd	48 x 48, 60 rd	BDNAC48048SBGPC	2,870	adj glides	polished
	custom higher height (specify height)	20	3" rd	30 x 30, 36 rd	BDNAC30030SHGPC	1,710	adj glides	polished
		24	4" rd	36 x 36, 42 rd	BDNAC36036SHGPC	1,800	adj glides	polished
		32	4" rd	42 x 42, 48 rd	BDNAC42042SHGPC	2,070	adj glides	polished
		32	6" rd	48 x 48, 60 rd	BDNAC48048SHGPC	2,870	adj glides	polished
custom lower height (specify height)	20	3" rd	30 x 30, 36 rd	BDNAC30030SLGPC	1,710	adj glides	polished	
	24	4" rd	36 x 36, 42 rd	BDNAC36036SLGPC	1,800	adj glides	polished	
	32	4" rd	42 x 42, 48 rd	BDNAC42042SLGPC	2,070	adj glides	polished	
	32	6" rd	48 x 48, 60 rd	BDNAC48048SLGPC	2,870	adj glides	polished	
Tondo (round column) 	27.75"H	22	3" rd	30 x 30, 36 rd	BDTON30030SDGME	870	adj glides	standard metal
		26	3" rd	36 x 36, 42 rd	BDTON36036SDGME	950	adj glides	standard metal
	40.75"H	22	3" rd	30 x 30, 36 rd	BDTON30030SBGME	960	adj glides	standard metal
		26	3" rd	36 x 36, 42 rd	BDTON36036SBGME	1,030	adj glides	standard metal
	custom higher height (specify height)	22	3" rd	30 x 30, 36 rd	BDTON30030SHGME	960	adj glides	standard metal
		26	3" rd	36 x 36, 42 rd	BDTON36036SHGME	1,030	adj glides	standard metal
	custom lower height (specify height)	22	3" rd	30 x 30, 36 rd	BDTON30030SLGME	960	adj glides	standard metal
		26	3" rd	36 x 36, 42 rd	BDTON36036SLGME	1,030	adj glides	standard metal
	27.75"H	22	3" rd	30 x 30, 36 rd	BDTON30030SDGPC	1,360	adj glides	polished
		26	3" rd	36 x 36, 42 rd	BDTON36036SDGPC	1,500	adj glides	polished
	40.75"H	22	3" rd	30 x 30, 36 rd	BDTON30030SBGPC	1,450	adj glides	polished
		26	3" rd	36 x 36, 42 rd	BDTON36036SBGPC	1,580	adj glides	polished
custom higher height (specify height)	22	3" rd	30 x 30, 36 rd	BDTON30030SHGPC	1,450	adj glides	polished	
	26	3" rd	36 x 36, 42 rd	BDTON36036SHGPC	1,580	adj glides	polished	
custom lower height (specify height)	22	3" rd	30 x 30, 36 rd	BDTON30030SLGPC	1,450	adj glides	polished	
	26	3" rd	36 x 36, 42 rd	BDTON36036SLGPC	1,580	adj glides	polished	



**Standard metal powder coat finishes (ME):**  
Black Wrinkle (BW), Chateau Brown Wrinkle (CB), Flat Black (FB),  
Furniture White (FW), Inner Tone (IT), Light Tone (LT), Medium Tone (MT),  
Metallic Silver (MS).

**Premium Polished Finish:**  
PC Polished Chrome (Nantes C & Tondo)

# bases

pneumatic height adjustable disc

Bennett, Nantes II, Tondo

base	base dim.	column	max top support	base model no.	list	glides	finish
 Bennett (square column)	16 x 16	sq	30 x 30, 36 rd	BDBEN30030SPGME	1,530	adj glides	standard metal
	20 x 20	sq	36 x 36, 42 rd	BDBEN36036SPGME	1,620	adj glides	standard metal
	26 x 26	sq	42 x 42, 48 rd	BDBEN42042SPGME	1,780	adj glides	standard metal
 Nantes II (round column)	20	rd	30 x 30, 36 rd	BDNA230030SPGME	1,470	adj glides	standard metal
	24	rd	36 x 36, 42 rd	BDNA236036SPGME	1,890	adj glides	standard metal
	32	rd	42 x 42, 48 rd	BDNA242042SPGME	2,070	adj glides	standard metal
 Tondo (round column)	22	rd	30 x 30, 36 rd	BDTON30030SPGME	1,940	adj glides	standard metal
	26	rd	36 x 36, 42 rd	BDTON36036SPGME	2,460	adj glides	standard metal

**Standard metal powder coat finishes (ME):**  
Flat Black (FB), Furniture White (FW), Metallic Silver (MS).

### Bennett, Nantes II and Tondo Pneumatic Height Adjustable Bases

P. Glide (plastic glide guidance) or Roller (steel roller guidance) Lift height adjustment:  
26.75" - 44.5" base height range (without table top)  
pneumatic cylinder assist with infinite stop positions  
no bounce cylinder stop  
unintentional release resistant lever with cable release

The weight of the top and all accessories that will be used on the base shall be advised on the purchase order. If the weight is set wrong then it will cause the table to lift up to fast or not work at all. Contact [service@symphonytables.com](mailto:service@symphonytables.com) for assistance.







Bennett & Nantes II lift capacity can be set at 33, 44, 55 or 66 lbs. for a lift range between 28 - 76 lbs.  
Tondo lift capacity can be set at 22, 33, or 44 lbs. for a lift range between 18 - 54 lbs.  
See chart for details:

Specify	Pound Equivalent	Lift Range
150N	33 lbs.	28-38 lbs.
200N	44 lbs.	34-54 lbs.
250N	55 lbs.	45-65 lbs.
300N	66 lbs.	56-76 lbs.

# bases

laptop, occasional

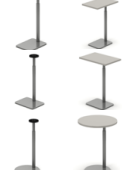
Nora, Dino, Polo, Keller

base	base dim.	column	max top support	base model no.	list	finish	
<b>Nora laptop</b>							
	rounded rectangle	10.5 x 15.5 x 24.5H	1.5" offset	14 x 20	BDNOR142024OGME	1,030	standard metal
		10.5 x 15.5 x 24.5H	1.5" offset	14 x 20	BDNOR142024OGPC	1,440	polished
	round	14 dia. x 24.5H	1.5" offset	20 rd	BDNOR20RD24OGME	1,000	standard metal
		14 dia. x 24.5H	1.5" offset	20 rd	BDNOR20RD24OGPC	1,250	polished
		14 dia. x 24.5H	1.5" centered	20 rd	BDNOR20RD24CGME	1,000	standard metal
		14 dia. x 24.5H	1.5" centered	20 rd	BDNOR20RD24CGPC	1,250	polished
	rounded square	15.5 sq. x 24.5H	1.5" centered	24 sq	BDNOR24RS24CGME	1,060	standard metal
		15.5 sq. x 24.5H	1.5" centered	24 sq	BDNOR24RS24CGPC	1,500	polished
		*Nora bases feature a plastic glide for carpet and hard floor surfaces, no adjustment					
<b>Dino fixed height laptop</b>							
	rectangle	9 x 12 x 25.25H	1.25" offset	12 x 18	BDDIN12018SDGME	430	standard metal
		12 x 9 x 25.25H	1.25" offset	18 x 12	BDDIN18012SDGME	430	standard metal
	round	12 dia. x 25.25H	1.25" offset	18 rd	BDDIN18000SDGME	430	standard metal
	*Dino bases feature 1" x 3/16" soft plastic foot pads/felt pads, no adjustment						
<b>Polo adjustable height laptop</b>							
	rectangle	9 x 12 x 25.25H	1.25" offset	12 x 18	BDPOL12018SPGME	780	standard metal
		12 x 9 x 25.25H	1.25" offset	18 x 12	BDPOL18012SPGME	780	standard metal
	round	12 dia. x 25.25H	1.25" offset	18 rd	BDPOL18000SPGME	780	standard metal
	*Polo bases feature a 20.25" - 30" pneumatic adjustable height range 1" x 3/16" soft plastic foot pads/felt pads, no adjustment						
<b>Keller occasional</b>							
		15.25 x 15.25 x 15H	2.25"	20 rd	BXKEL2002015GME	610	standard metal
		15.25 x 15.25 x 17H	2.25"	20 rd	BXKEL2002017GME	610	standard metal
		15.25 x 15.25 x 19H	2.25"	20 rd	BXKEL2002019GME	610	standard metal
		15.25 x 15.25 x 15H	2.25"	20 rd	BXKEL2002015GPO	700	polished
		15.25 x 15.25 x 17H	2.25"	20 rd	BXKEL2002017GPO	700	polished
		15.25 x 15.25 x 19H	2.25"	20 rd	BXKEL2002019GPO	700	polished

**(ME) Standard metal powder coat finishes (Nora + Keller)**  
Black Wrinkle (BW), Chateau Brown Wrinkle (CB), Flat Black (FB), Furniture White (FW), Inner Tone (IT), Light Tone (LT), Medium Tone (MT), Metallic Silver (MS).

**(PC) Polished chrome finish (Nora laptop)**  
**(PO) Polished aluminum/chrome (Keller occasional)**

**(ME) Standard metal powder coat finishes (Dino + Polo)**  
Flat Black, Furniture White, Inner Tone, Light Tone, Medium Tone, and Metallic Silver

\*\* Note that the inner column of the Polo height adjustable base is only available in Flat Black, White or Metallic Silver. Note that Polo White is a shade off and a little creamier

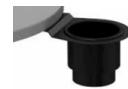



**Optional Cup Holder - \$100 list**  
model number **ASCUPHLDR**

# bases

occasional

Nora

base	base dim.	column	max top support	base model no.	list	finish	
<b>Nora occasional</b>							
	round	14 dia. x 15H	1.5" centered	20 rd	BDNOR20RD15CGME	980	standard metal
		14 dia. x 17H	1.5" centered	20 rd	BDNOR20RD17CGME	980	standard metal
		14 dia. x 19H	1.5" centered	20 rd	BDNOR20RD19CGME	980	standard metal
		14 dia. x 21H	1.5" centered	20 rd	BDNOR20RD21CGME	980	standard metal
		18 dia. x 15H	1.5" centered	30 rd	BDNOR30RD15CGME	1,080	standard metal
		18 dia. x 17H	1.5" centered	30 rd	BDNOR30RD17CGME	1,080	standard metal
		18 dia. x 19H	1.5" centered	30 rd	BDNOR30RD19CGME	1,080	standard metal
		18 dia. x 21H	1.5" centered	30 rd	BDNOR30RD21CGME	1,080	standard metal
		23 dia. x 15H	3" centered	42 rd	BDNOR42RD15CGME	1,140	standard metal
		23 dia. x 17H	3" centered	42 rd	BDNOR42RD17CGME	1,140	standard metal
		23 dia. x 19H	3" centered	42 rd	BDNOR42RD19CGME	1,140	standard metal
		23 dia. x 21H	3" centered	42 rd	BDNOR42RD21CGME	1,140	standard metal
		14 dia. x 15H	1.5" centered	20 rd	BDNOR20RD15CGPC	1,230	polished
		14 dia. x 17H	1.5" centered	20 rd	BDNOR20RD17CGPC	1,230	polished
		14 dia. x 19H	1.5" centered	20 rd	BDNOR20RD19CGPC	1,230	polished
		14 dia. x 21H	1.5" centered	20 rd	BDNOR20RD21CGPC	1,230	polished
	18 dia. x 15H	1.5" centered	30 rd	BDNOR30RD15CGPC	1,380	polished	
	18 dia. x 17H	1.5" centered	30 rd	BDNOR30RD17CGPC	1,380	polished	
	18 dia. x 19H	1.5" centered	30 rd	BDNOR30RD19CGPC	1,380	polished	
	18 dia. x 21H	1.5" centered	30 rd	BDNOR30RD21CGPC	1,380	polished	
	23 dia. x 15H	3" centered	42 rd	BDNOR42RD15CGPC	1,570	polished	
	23 dia. x 17H	3" centered	42 rd	BDNOR42RD17CGPC	1,570	polished	
	23 dia. x 19H	3" centered	42 rd	BDNOR42RD19CGPC	1,570	polished	
	23 dia. x 21H	3" centered	42 rd	BDNOR42RD21CGPC	1,570	polished	
	rounded square	15.5 x 15.5 x 15H	1.5" centered	24 sq	BDNOR24RS15CGME	1,010	standard metal
		15.5 x 15.5 x 17H	1.5" centered	24 sq	BDNOR24RS17CGME	1,010	standard metal
		15.5 x 15.5 x 19H	1.5" centered	24 sq	BDNOR24RS19CGME	1,010	standard metal
		15.5 x 15.5 x 21H	1.5" centered	24 sq	BDNOR24RS21CGME	1,010	standard metal
	18 x 18 x 15H	3" centered	36 sq	BDNOR36RS15CGME	1,050	standard metal	
	18 x 18 x 17H	3" centered	36 sq	BDNOR36RS17CGME	1,050	standard metal	
	18 x 18 x 19H	3" centered	36 sq	BDNOR36RS19CGME	1,050	standard metal	
	18 x 18 x 21H	3" centered	36 sq	BDNOR36RS21CGME	1,050	standard metal	
	23 x 23 x 15H	3" centered	42 sq	BDNOR42RS15CGME	1,170	standard metal	
	23 x 23 x 17H	3" centered	42 sq	BDNOR42RS17CGME	1,170	standard metal	
	23 x 23 x 19H	3" centered	42 sq	BDNOR42RS19CGME	1,170	standard metal	
	23 x 23 x 21H	3" centered	42 sq	BDNOR42RS21CGME	1,170	standard metal	
	rounded rectangle	12 x 18 x 15H	1.5" centered	18 x 24	BDNOR1802415CGME	1,050	standard metal
		12 x 18 x 17H	1.5" centered	18 x 24	BDNOR1802417CGME	1,050	standard metal
		12 x 18 x 19H	1.5" centered	18 x 24	BDNOR1802419CGME	1,050	standard metal
		12 x 18 x 21H	1.5" centered	18 x 24	BDNOR1802421CGME	1,050	standard metal

**(ME) Standard metal powder coat finishes (Nora)**  
Black Wrinkle (BW), Chateau Brown Wrinkle (CB), Flat Black (FB), Furniture White (FW), Inner Tone (IT), Light Tone (LT), Medium Tone (MT), Metallic Silver (MS).

**(PC) Polished chrome finish (Nora round bases only)**

**FIXED BASE HEIGHT + 1.25" THICK TOP DIMENSIONS**









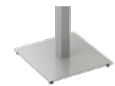

**Examples:**  
15" base height + 1.25" top thickness = 16.25" overall table height  
17" base height + 1.25" top thickness = 18.25" overall table height  
19" base height + 1.25" top thickness = 20.25" overall table height  
21" base height + 1.25" top thickness = 22.25" overall table height



# bases

## occasional

Bennett, Marius, Molly, Moto, Zoey, Keller, Ria, Nantes II, Nantes C, Tondo

base	base dim. (specify height)	column	max top support	base model no.	list	finish	
Bennett (square column)		16 x 16	3" sq	30 x 30, 36 rd	BDBEN30030SLGME	880	standard metal
		20 x 20	3" sq	36 x 36, 42 rd	BDBEN36036SLGME	950	standard metal
		26 x 26	3" sq	42 x 42, 48 rd	BDBEN42042SLGME	1,130	standard metal
Marius (round column)		16 x 16	3" rd	30 x 30, 36 rd	BDMAR30030SLGME	880	standard metal
		20 x 20	4" rd	36 x 36, 42 rd	BDMAR36036SLGME	950	standard metal
		26 x 26	4" rd	42 x 42, 48 rd	BDMAR42042SLGME	1,130	standard metal
		24 x 24	6" rd	48 x 48, 48 rd	BDMAR48048SLGME	1,490	standard metal
		18 x 28	6" rd	36 x 60	BDMAR36060SLGME	1,520	standard metal
rectangle disc		26 x 30	6" rd	42 x 60	BDMAR42060SLGME	1,550	standard metal
		Molly (round column)		16 x 16	3" rd	30 x 30, 36 rd	BDMOL30030SLGME
20 x 20	4" rd	36 x 36, 42 rd		BDMOL36036SLGME	950	standard metal	
26 x 26	4" rd	42 x 42, 48 rd		BDMOL42042SLGME	1,130	standard metal	
Moto (square column)		22 x 22	3" sq	24 x 24, 24 rd	BXMOT24024SLGME	760	standard metal
		26 x 26	3" sq	30 x 30, 36 rd	BXMOT30030SLGME	790	standard metal
		32 x 32	3" sq	36 x 36, 42 rd	BXMOT36036SLGME	860	standard metal
		36 x 36	3" sq	42 x 42, 48 rd	BXMOT42042SLGME	880	standard metal
Zoey		21 x 21	n/a	24 x 24, 24 rd	BXZOE24024SLGME	720	standard metal
		27 x 27	n/a	30 x 30, 36 rd	BXZOE30030SLGME	750	standard metal
		33 x 33	n/a	36 x 36, 42 rd	BXZOE36036SLGME	780	standard metal
Keller (round column)		20 x 20	2.25" rd	24 x 24, 24 rd	BXKEL24024SLGME	700	standard metal
		26 x 26	2.25" rd	30 x 30, 36 rd	BXKEL30030SLGME	760	standard metal
		33 x 33	2.25" rd	36 x 36, 42 rd	BXKEL36036SLGME	800	standard metal
		38 x 38	2.25" rd	42 x 42, 48 rd	BXKEL42042SLGME	920	standard metal
		20 x 20	2.25" rd	24 x 24, 24 rd	BXKEL24024SLGPO	790	polished
		26 x 26	2.25" rd	30 x 30, 36 rd	BXKEL30030SLGPO	860	polished
33 x 33	2.25" rd	36 x 36, 42 rd	BXKEL36036SLGPO	900	polished		
38 x 38	2.25" rd	42 x 42, 48 rd	BXKEL42042SLGPO	1,020	polished		
Ria (round column)		20 x 20	2.25" rd	24 x 24, 24 rd	BXRIA24024SLGME	610	standard metal
		26 x 26	2.25" rd	30 x 30, 36 rd	BXRIA30030SLGME	640	standard metal
		33 x 33	2.25" rd	36 x 36, 42 rd	BXRIA36036SLGME	740	standard metal
		38 x 38	2.25" rd	42 x 42, 48 rd	BXRIA42042SLGME	800	standard metal
		20 x 20	2.25" rd	24 x 24, 24 rd	BXRIA24024SLGPO	700	polished
		26 x 26	2.25" rd	30 x 30, 36 rd	BXRIA30030SLGPO	740	polished
33 x 33	2.25" rd	36 x 36, 42 rd	BXRIA36036SLGPO	840	polished		
38 x 38	2.25" rd	42 x 42, 48 rd	BXRIA42042SLGPO	900	polished		
Nantes II (round column)		20 dia.	3" rd	30 x 30, 36 rd	BDNA230030SLGME	880	standard metal
		24 dia.	4" rd	36 x 36, 42 rd	BDNA236036SLGME	950	standard metal
		32 dia.	4" rd	42 x 42, 48 rd	BDNA242042SLGME	1,130	standard metal
Nantes C with cover (round column)		20 dia.	3" rd	30 x 30, 36 rd	BDNAC30030SLGPC	1,660	polished
		24 dia.	4" rd	36 x 36, 42 rd	BDNAC36036SLGPC	1,800	polished
		32 dia.	4" rd	42 x 42, 48 rd	BDNAC42042SLGPC	2,080	polished
Tondo		22 dia.	3" rd	30 x 30, 36 rd	BDTON30030SLGME	960	standard metal
		26 dia.	3" rd	36 x 36, 42 rd	BDTON36036SLGME	1,050	standard metal
		22 dia.	3" rd	30 x 30, 36 rd	BDTON30030SLGPC	1,460	polished
		26 dia.	3" rd	36 x 36, 42 rd	BDTON36036SLGPC	1,600	polished

Specify custom lower base height. Note that a standard PVEA PVC edge top will add 1.25" to the overall height of the table

### Examples:

16.75" base height + 1.25" top thickness = 18" overall table height  
18.75" base height + 1.25" top thickness = 20" overall table height  
22.75" base height + 1.25" top thickness = 24" overall table height

All occasional bases on this page have adjustable glides

### (ME) Standard metal powder coat finishes :

Black Wrinkle (BW), Chateau Brown Wrinkle (CB), Flat Black (FB), Furniture White (FW), Inner Tone (IT), Light Tone (LT), Medium Tone (MT), Metallic Silver (MS).



(PC) Polished chrome finish (Nantes / Tondo)

(PO) Polished aluminum / chrome finish (Keller / Ria)

# bases

## conference sets

Bassa

base	base dim.	qty	max top support	base set model no.	list	finish		
Bassa rectangular frame		solid metal panel	18 x 6 x 27.75	2	36 x 96	BFBAS36096REGSM	3,980	standard metal
			18 x 6 x 27.75	3	36 x 144	BFBAS36144REGSM	5,960	standard metal
			18 x 6 x 27.75	4	36 x 192	BFBAS36192REGSM	7,950	standard metal
			24 x 6 x 27.75	2	48 x 96	BFBAS48096REGSM	4,070	standard metal
		24 x 6 x 27.75	3	48 x 144	BFBAS48144REGSM	6,130	standard metal	
		24 x 6 x 27.75	4	48 x 192	BFBAS48192REGSM	8,170	standard metal	
		perforated metal panel	34 x 6 x 27.75	2	60 x 96	BFBAS60096REGSM	4,330	standard metal
			34 x 6 x 27.75	3	60 x 144	BFBAS60144REGSM	6,520	standard metal
			34 x 6 x 27.75	4	60 x 192	BFBAS60192REGSM	8,700	standard metal
			18 x 6 x 27.75	2	36 x 96	BFBAS36096REGPM	4,040	standard metal
			18 x 6 x 27.75	3	36 x 144	BFBAS36144REGPM	6,070	standard metal
			18 x 6 x 27.75	4	36 x 192	BFBAS36192REGPM	8,090	standard metal
24 x 6 x 27.75	2		48 x 96	BFBAS48096REGPM	4,140	standard metal		
24 x 6 x 27.75	3		48 x 144	BFBAS48144REGPM	6,200	standard metal		
24 x 6 x 27.75	4	48 x 192	BFBAS48192REGPM	8,270	standard metal			
34 x 6 x 27.75	2	60 x 96	BFBAS60096REGPM	4,620	standard metal			
34 x 6 x 27.75	3	60 x 144	BFBAS60144REGPM	6,920	standard metal			
34 x 6 x 27.75	4	60 x 192	BFBAS60192REGPM	9,220	standard metal			
Bassa curved frame		solid metal panel	20 x 6 x 27.75	2	36 x 96	BFBAS36096CUGSM	3,970	standard metal
			20 x 6 x 27.75	3	36 x 144	BFBAS36144CUGSM	5,950	standard metal
			20 x 6 x 27.75	4	36 x 192	BFBAS36192CUGSM	7,930	standard metal
			26 x 6 x 27.75	2	48 x 96	BFBAS48096CUGSM	4,050	standard metal
			26 x 6 x 27.75	3	48 x 144	BFBAS48144CUGSM	6,080	standard metal
			26 x 6 x 27.75	4	48 x 192	BFBAS48192CUGSM	8,110	standard metal
		perforated metal panel	36 x 6 x 27.75	2	60 x 96	BFBAS60096CUGSM	4,520	standard metal
			36 x 6 x 27.75	3	60 x 144	BFBAS60144CUGSM	6,780	standard metal
			36 x 6 x 27.75	4	60 x 192	BFBAS60192CUGSM	9,030	standard metal
			20 x 6 x 27.75	2	36 x 96	BFBAS36096CUGPM	4,020	standard metal
			20 x 6 x 27.75	3	36 x 144	BFBAS36144CUGPM	6,030	standard metal
			20 x 6 x 27.75	4	36 x 192	BFBAS36192CUGPM	8,030	standard metal
			26 x 6 x 27.75	2	48 x 96	BFBAS48096CUGPM	4,110	standard metal
			26 x 6 x 27.75	3	48 x 144	BFBAS48144CUGPM	6,170	standard metal
			26 x 6 x 27.75	4	48 x 192	BFBAS48192CUGPM	8,220	standard metal
			36 x 6 x 27.75	2	60 x 96	BFBAS60096CUGPM	4,510	standard metal
			36 x 6 x 27.75	3	60 x 144	BFBAS60144CUGPM	6,780	standard metal
			36 x 6 x 27.75	4	60 x 192	BFBAS60192CUGPM	9,030	standard metal

### (ME) Standard metal powder coat finishes (Bassa)

Flat Black (FB), Furniture White (FW), Inner Tone (IT), Light Tone (LT), Medium Tone (MT), Metallic Silver (MS).

\*laminated panels are available for Bassa, email service@symphonytables.com for pricing

bases  
conference sets  
Lastra rectangle

base	base dim.	qty	max top support	base set model no.	list	laminata grade
Lastra 6" rectangle 	27.75"H	18 x 6	2 42 x 96	BLLAR420962DGLA	1,500	A
		18 x 6	3 42 x 144	BLLAR421443DGLA	2,240	A
		18 x 6	4 42 x 192	BLLAR421924DGLA	2,970	A
		18 x 6	2 42 x 96	BLLAR420962DGLB	1,550	B
		18 x 6	3 42 x 144	BLLAR421443DGLB	2,330	B
		18 x 6	4 42 x 192	BLLAR421924DGLB	3,110	B
		18 x 6	2 42 x 96	BLLAR420962DGLC	1,820	C
		18 x 6	3 42 x 144	BLLAR421443DGLC	2,730	C
		18 x 6	4 42 x 192	BLLAR421924DGLC	3,630	C
		24 x 6	2 48 x 96	BLLAR480962DGLA	1,740	A
		24 x 6	3 48 x 144	BLLAR481443DGLA	2,610	A
		24 x 6	4 48 x 192	BLLAR481924DGLA	3,420	A
	24 x 6	2 48 x 96	BLLAR480962DGLB	1,790	B	
	24 x 6	3 48 x 144	BLLAR481443DGLB	2,700	B	
	24 x 6	4 48 x 192	BLLAR481924DGLB	3,590	B	
	24 x 6	2 48 x 96	BLLAR480962DGLC	2,100	C	
	24 x 6	3 48 x 144	BLLAR481443DGLC	3,150	C	
	24 x 6	4 48 x 192	BLLAR481924DGLC	4,190	C	
	30 x 6	2 60 x 96	BLLAR600962DGLA	2,020	A	
	30 x 6	3 60 x 144	BLLAR601443DGLA	3,030	A	
	30 x 6	4 60 x 192	BLLAR601924DGLA	4,020	A	
	30 x 6	2 60 x 96	BLLAR600962DGLB	2,100	B	
	30 x 6	3 60 x 144	BLLAR601443DGLB	3,160	B	
	30 x 6	4 60 x 192	BLLAR601924DGLB	4,210	B	
30 x 6	2 60 x 96	BLLAR600962DGLC	2,460	C		
30 x 6	3 60 x 144	BLLAR601443DGLC	3,700	C		
30 x 6	4 60 x 192	BLLAR601924DGLC	4,920	C		
Lastra 12" rectangle	27.75"H	18 x 12	2 42 x 108	BLLAR421082DGLA	1,620	A
		18 x 12	3 42 x 156	BLLAR421563DGLA	2,420	A
		18 x 12	4 42 x 228	BLLAR422284DGLA	3,210	A
		18 x 12	2 42 x 108	BLLAR421082DGLB	1,680	B
		18 x 12	3 42 x 156	BLLAR421563DGLB	2,530	B
		18 x 12	4 42 x 228	BLLAR422284DGLB	3,380	B
		18 x 12	2 42 x 108	BLLAR421082DGLC	1,980	C
		18 x 12	3 42 x 156	BLLAR421563DGLC	2,970	C
		18 x 12	4 42 x 228	BLLAR422284DGLC	3,960	C
		24 x 12	2 48 x 108	BLLAR481082DGLA	1,830	A
		24 x 12	3 48 x 156	BLLAR481563DGLA	2,740	A
		24 x 12	4 48 x 228	BLLAR482284DGLA	3,650	A
	24 x 12	2 48 x 108	BLLAR481082DGLB	1,910	B	
	24 x 12	3 48 x 156	BLLAR481563DGLB	2,860	B	
	24 x 12	4 48 x 228	BLLAR482284DGLB	3,830	B	
	24 x 12	2 48 x 108	BLLAR481082DGLC	2,230	C	
	24 x 12	3 48 x 156	BLLAR481563DGLC	3,370	C	
	24 x 12	4 48 x 228	BLLAR482284DGLC	4,480	C	
	30 x 12	2 60 x 108	BLLAR601082DGLA	2,130	A	
	30 x 12	3 60 x 156	BLLAR601563DGLA	3,210	A	
	30 x 12	4 60 x 228	BLLAR602284DGLA	4,220	A	
	30 x 12	2 60 x 108	BLLAR601082DGLB	2,220	B	
	30 x 12	3 60 x 156	BLLAR601563DGLB	3,330	B	
	30 x 12	4 60 x 228	BLLAR602284DGLB	4,440	B	
	30 x 12	2 60 x 108	BLLAR601082DGLC	2,610	C	
	30 x 12	3 60 x 156	BLLAR601563DGLC	3,890	C	
	30 x 12	4 60 x 228	BLLAR602284DGLC	5,200	C	

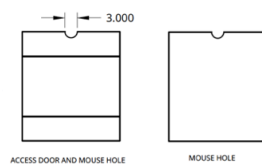

Lastra hinged access door option:  
14.75"H hinged access door (1) for a seated height base,  
model # OBLASDH129 - \$190 list each

\*Lastra wire management mouse holes come on BOTH SIDES at the top / center of all bases in the set unless the base is specified with no wire management mouse holes, please indicate that you do not want mouse holes on one or both sides of the base in **bold face ALL CAPS** on your PO.

\* Lastra rectangle and square interior base dimensions are 1.5" less than the "W x D" dimension listed above for each base  
\* the bottom of the Lastra base is open to the floor

bases  
conference sets  
Lastra rectangle

base	base dim.	qty	max top support	base set model no.	list	laminata grade	
Lastra 6" rectangle	40.75"H	18 x 6	2 42 x 96	BLLAR420962HGLA	1,720	A	
		18 x 6	3 42 x 144	BLLAR421443HGLA	2,560	A	
		18 x 6	4 42 x 192	BLLAR421924HGLA	3,660	A	
		18 x 6	2 42 x 96	BLLAR420962HGLB	1,910	B	
		18 x 6	3 42 x 144	BLLAR421443HGLB	2,870	B	
		18 x 6	4 42 x 192	BLLAR421924HGLB	3,840	B	
		18 x 6	2 42 x 96	BLLAR420962HGLC	2,260	C	
		18 x 6	3 42 x 144	BLLAR421443HGLC	3,390	C	
		18 x 6	4 42 x 192	BLLAR421924HGLC	4,510	C	
		24 x 6	2 48 x 96	BLLAR480962HGLA	2,170	A	
		24 x 6	3 48 x 144	BLLAR481443HGLA	3,250	A	
		24 x 6	4 48 x 192	BLLAR481924HGLA	3,750	A	
		24 x 6	2 48 x 96	BLLAR480962HGLB	2,210	B	
		24 x 6	3 48 x 144	BLLAR481443HGLB	2,960	B	
		24 x 6	4 48 x 192	BLLAR481924HGLB	3,950	B	
		24 x 6	2 48 x 96	BLLAR480962HGLC	2,320	C	
		24 x 6	3 48 x 144	BLLAR481443HGLC	3,470	C	
		24 x 6	4 48 x 192	BLLAR481924HGLC	4,620	C	
		30 x 6	2 60 x 96	BLLAR600962HGLA	2,210	A	
		30 x 6	3 60 x 144	BLLAR601443HGLA	3,310	A	
		30 x 6	4 60 x 192	BLLAR601924HGLA	4,410	A	
		30 x 6	2 60 x 96	BLLAR600962HGLB	2,320	B	
		30 x 6	3 60 x 144	BLLAR601443HGLB	3,470	B	
		30 x 6	4 60 x 192	BLLAR601924HGLB	4,630	B	
	30 x 6	2 60 x 96	BLLAR600962HGLC	2,710	C		
	30 x 6	3 60 x 144	BLLAR601443HGLC	4,060	C		
	30 x 6	4 60 x 192	BLLAR601924HGLC	5,430	C		
	Lastra 12" rectangle	40.75"H	18 x 12	2 42 x 108	BLLAR421082HGLA	2,150	A
			18 x 12	3 42 x 156	BLLAR421563HGLA	3,220	A
			18 x 12	4 42 x 228	BLLAR422284HGLA	4,290	A
			18 x 12	2 42 x 108	BLLAR421082HGLB	2,260	B
			18 x 12	3 42 x 156	BLLAR421563HGLB	3,380	B
			18 x 12	4 42 x 228	BLLAR422284HGLB	4,500	B
			18 x 12	2 42 x 108	BLLAR421082HGLC	2,660	C
			18 x 12	3 42 x 156	BLLAR421563HGLC	3,990	C
			18 x 12	4 42 x 228	BLLAR422284HGLC	5,320	C
			24 x 12	2 48 x 108	BLLAR481082HGLA	2,540	A
			24 x 12	3 48 x 156	BLLAR481563HGLA	3,810	A
			24 x 12	4 48 x 228	BLLAR482284HGLA	5,070	A
		24 x 12	2 48 x 108	BLLAR481082HGLB	2,660	B	
		24 x 12	3 48 x 156	BLLAR481563HGLB	3,990	B	
		24 x 12	4 48 x 228	BLLAR482284HGLB	5,320	B	
		24 x 12	2 48 x 108	BLLAR481082HGLC	3,140	C	
		24 x 12	3 48 x 156	BLLAR481563HGLC	4,720	C	
		24 x 12	4 48 x 228	BLLAR482284HGLC	6,280	C	
		30 x 12	2 60 x 108	BLLAR601082HGLA	3,230	A	
		30 x 12	3 60 x 156	BLLAR601563HGLA	4,860	A	
		30 x 12	4 60 x 228	BLLAR602284HGLA	6,480	A	
30 x 12		2 60 x 108	BLLAR601082HGLB	3,400	B		
30 x 12		3 60 x 156	BLLAR601563HGLB	5,090	B		
30 x 12		4 60 x 228	BLLAR602284HGLB	6,800	B		
30 x 12	2 60 x 108	BLLAR601082HGLC	4,020	C			
30 x 12	3 60 x 156	BLLAR601563HGLC	6,030	C			
30 x 12	4 60 x 228	BLLAR602284HGLC	8,020	C			

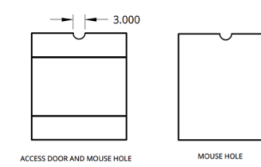

Lastra hinged access door option:  
15.75"H hinged access door (1) for a standing height base, model # OBLASDH142 - \$210 list each

\*Lastra wire management mouse holes come on BOTH SIDES at the top / center of all bases in the set unless the base is specified with no wire management mouse holes, please indicate that you do not want mouse holes on one or both sides of the base in **bold face ALL CAPS** on your PO.

\* Lastra rectangle and square interior base dimensions are 1.5" less than the "W x D" dimension listed above for each base  
\* the bottom of the Lastra base is open to the floor

bases  
conference sets  
Lastra square

base	base dim.	qty	max top support	base set model no.	list	laminata grade	
Lastra square	27.75"H	18 x 18	2	42 x 120	BLLAS42120D2GLA	2,240	A
		18 x 18	3	42 x 192	BLLAS42192D3GLA	3,380	A
		18 x 18	2	42 x 120	BLLAS42120D2GLB	2,270	B
		18 x 18	3	42 x 192	BLLAS42192D3GLB	3,400	B
		18 x 18	2	42 x 120	BLLAS42120D2GLC	2,670	C
		18 x 18	3	42 x 192	BLLAS42192D3GLC	4,000	C
		24 x 24	2	48 x 132	BLLAS48132D2GLA	2,350	A
		24 x 24	3	48 x 204	BLLAS48204D3GLA	3,540	A
		24 x 24	2	48 x 132	BLLAS48132D2GLB	2,390	B
		24 x 24	3	48 x 204	BLLAS48204D3GLB	3,560	B
	24 x 24	2	48 x 132	BLLAS48132D2GLC	2,790	C	
	24 x 24	3	48 x 204	BLLAS48204D3GLC	4,170	C	
	30 x 30	2	60 x 144	BLLAS60144D2GLA	2,680	A	
	30 x 30	3	60 x 216	BLLAS60216D3GLA	4,040	A	
	30 x 30	2	60 x 144	BLLAS60144D2GLB	2,720	B	
	30 x 30	3	60 x 216	BLLAS60216D3GLB	4,060	B	
	30 x 30	2	60 x 144	BLLAS60144D2GLC	3,180	C	
	30 x 30	3	60 x 216	BLLAS60216D3GLC	4,750	C	
	40.75"H	18 x 18	2	42 x 120	BLLAS42120H2GLA	2,480	A
			3	42 x 192	BLLAS42192H3GLA	3,710	A
2			42 x 120	BLLAS42120H2GLB	2,510	B	
3			42 x 192	BLLAS42192H3GLB	3,740	B	
2			42 x 120	BLLAS42120H2GLC	2,960	C	
3			42 x 192	BLLAS42192H3GLC	4,420	C	
24 x 24			2	48 x 132	BLLAS48132H2GLA	2,590	A
24 x 24			3	48 x 204	BLLAS48204H3GLA	3,870	A
24 x 24			2	48 x 132	BLLAS48132H2GLB	2,620	B
24 x 24			3	48 x 204	BLLAS48204H3GLB	3,910	B
24 x 24		2	48 x 132	BLLAS48132H2GLC	3,070	C	
24 x 24		3	48 x 204	BLLAS48204H3GLC	4,590	C	
30 x 30		2	60 x 144	BLLAS60144H2GLA	3,140	A	
30 x 30		3	60 x 216	BLLAS60216H3GLA	4,710	A	
30 x 30		2	60 x 144	BLLAS60144H2GLB	3,170	B	
30 x 30		3	60 x 216	BLLAS60216H3GLB	4,740	B	
30 x 30		2	60 x 144	BLLAS60144H2GLC	3,720	C	
30 x 30		3	60 x 216	BLLAS60216H3GLC	5,560	C	

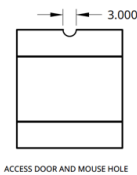

**Lastra hinged access door option:**  
14.75"H hinged access door (1) for a seated height base, model # **OBLASDH129** - \$190 list each.  
15.75"H hinged access door (1) for a standing height base, model # **OBLASDH142** - \$210 list each

\*Lastra wire management mouse holes come on BOTH SIDES at the top / center of all bases in the set unless the base is specified with no wire management mouse holes, please indicate that you do not want mouse holes on one or both sides of the base in **bold face ALL CAPS** on your PO.

\* Lastra rectangle and square interior base dimensions are 1.5" less than the "W x D" dimension listed above for each base  
\* the bottom of the Lastra base is open to the floor

bases  
conference sets  
Tambo cylinder

base	base dim.	qty	max top support	base set model no.	list	laminata grade		
Tambo cylinder	27.75"H	18	2	42 x 120	BLTAM42120D2GLA	2,050	A	
		18	3	42 x 192	BLTAM42192D3GLA	3,070	A	
		18	2	42 x 120	BLTAM42120D2GLB	2,240	B	
		18	3	42 x 192	BLTAM42192D3GLB	3,380	B	
		18	2	42 x 120	BLTAM42120D2GLC	2,440	C	
		18	3	42 x 192	BLTAM42192D3GLC	3,690	C	
		24	2	48 x 132	BLTAM48132D2GLA	2,680	A	
		24	3	48 x 204	BLTAM48204D3GLA	4,030	A	
		24	2	48 x 132	BLTAM48132D2GLB	2,960	B	
		24	3	48 x 204	BLTAM48204D3GLB	4,430	B	
		24	2	48 x 132	BLTAM48132D2GLC	3,220	C	
		24	3	48 x 204	BLTAM48204D3GLC	4,840	C	
		30	2	60 x 144	BLTAM60144D2GLA	3,180	A	
		30	3	60 x 216	BLTAM60216D3GLA	4,770	A	
		30	2	60 x 144	BLTAM60144D2GLB	3,510	B	
		30	3	60 x 216	BLTAM60216D3GLB	5,250	B	
		30	2	60 x 144	BLTAM60144D2GLC	3,820	C	
		30	3	60 x 216	BLTAM60216D3GLC	5,730	C	
		40.75"H	18	2	42 x 120	BLTAM42120H2GLA	2,410	A
				3	42 x 192	BLTAM42192H3GLA	3,610	A
	2			42 x 120	BLTAM42120H2GLB	2,650	B	
	3			42 x 192	BLTAM42192H3GLB	3,980	B	
	2			42 x 120	BLTAM42120H2GLC	2,880	C	
	3			42 x 192	BLTAM42192H3GLC	4,330	C	
	24			2	48 x 132	BLTAM48132H2GLA	3,160	A
	24			3	48 x 204	BLTAM48204H3GLA	4,740	A
	24			2	48 x 132	BLTAM48132H2GLB	3,480	B
	24			3	48 x 204	BLTAM48204H3GLB	5,210	B
	24		2	48 x 132	BLTAM48132H2GLC	3,800	C	
	24		3	48 x 204	BLTAM48204H3GLC	5,690	C	
	30		2	60 x 144	BLTAM60144H2GLA	3,740	A	
	30		3	60 x 216	BLTAM60216H3GLA	5,620	A	
	30		2	60 x 144	BLTAM60144H2GLB	4,130	B	
	30		3	60 x 216	BLTAM60216H3GLB	6,180	B	
	30		2	60 x 144	BLTAM60144H2GLC	4,490	C	
	30		3	60 x 216	BLTAM60216H3GLC	6,730	C	



**Tambo laminate base options:**

10 x 10 side hinged curved access door for a cylinder base, model # **OBLTAMWMD** - \$610 list per door  
50 LB ballast bag, model # **OBLTAMBAL** - \$180 list per bag

\* Tambo cylinder bases have 4 metal top plates to mount the base to the top, there is a 9.5" hole centered at the top and bottom of the base. Tambo bases do not come with wire management mouse holes.



# bases

under table media

base	base length	qty	base model no.	list	laminata grade	
6" under table media	27.75"H	36	1	AMW360628FUTA	1,160	A
		42	1	AMW420628FUTA	1,510	A
		48	1	AMW480628FUTA	1,530	A
		54	1	AMW540628FUTA	1,770	A
		60	1	AMW600628FUTA	1,790	A
		36	1	AMW360628FUTB	1,200	B
	42	1	AMW420628FUTB	1,580	B	
	48	1	AMW480628FUTB	1,620	B	
	54	1	AMW540628FUTB	1,870	B	
	60	1	AMW600628FUTB	1,890	B	
	36	1	AMW360628FUTC	1,350	C	
	42	1	AMW420628FUTC	1,780	C	
	48	1	AMW480628FUTC	1,800	C	
	54	1	AMW540628FUTC	2,090	C	
	60	1	AMW600628FUTC	2,110	C	
	34.75"H	36	1	AMW360635FUTA	1,500	A
		42	1	AMW420635FUTA	1,950	A
		48	1	AMW480635FUTA	1,970	A
		54	1	AMW540635FUTA	2,270	A
		60	1	AMW600635FUTA	2,290	A
		36	1	AMW360635FUTB	1,580	B
	42	1	AMW420635FUTB	2,050	B	
	48	1	AMW480635FUTB	2,080	B	
	54	1	AMW540635FUTB	2,390	B	
60	1	AMW600635FUTB	2,410	B		
36	1	AMW360635FUTC	1,690	C		
42	1	AMW420635FUTC	2,220	C		
48	1	AMW480635FUTC	2,240	C		
54	1	AMW540635FUTC	2,590	C		
60	1	AMW600635FUTC	2,620	C		
40.75"H	36	1	AMW360641FUTA	1,800	A	
	42	1	AMW420641FUTA	2,340	A	
	48	1	AMW480641FUTA	2,380	A	
	54	1	AMW540641FUTA	2,720	A	
	60	1	AMW600641FUTA	2,760	A	
	36	1	AMW360641FUTB	1,900	B	
42	1	AMW420641FUTB	2,460	B		
48	1	AMW480641FUTB	2,500	B		
54	1	AMW540641FUTB	2,860	B		
60	1	AMW600641FUTB	2,880	B		
36	1	AMW360641FUTC	2,050	C		
42	1	AMW420641FUTC	2,670	C		
48	1	AMW480641FUTC	2,700	C		
54	1	AMW540641FUTC	3,100	C		
60	1	AMW600641FUTC	3,140	C		

Please specify a back option:

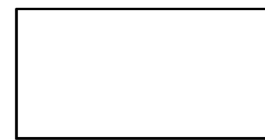

SOLID BACK  
model number **OMWSOBK** - \$0 list

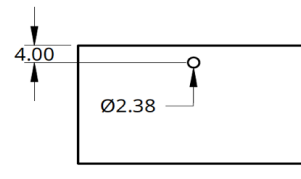

BACK WITH (1) GROMMET  
model number **OMWGR1BK** - \$30 list

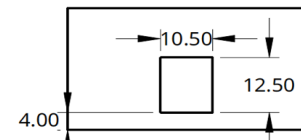

BACK WITH (1) CUTOUT  
model number **OMWCO1BK** - \$50 list

# bases

under table media

base	base length	qty	base model no.	list	laminata grade	
12" under table media	27.75"H	36	1	AMW361228FUTA	1,250	A
		42	1	AMW421228FUTA	1,680	A
		48	1	AMW481228FUTA	1,720	A
		54	1	AMW541228FUTA	2,020	A
		60	1	AMW601228FUTA	2,050	A
		36	1	AMW361228FUTB	1,320	B
	42	1	AMW421228FUTB	1,770	B	
	48	1	AMW481228FUTB	1,790	B	
	54	1	AMW541228FUTB	2,110	B	
	60	1	AMW601228FUTB	2,150	B	
	36	1	AMW361228FUTC	1,470	C	
	42	1	AMW421228FUTC	1,980	C	
	48	1	AMW481228FUTC	2,010	C	
	54	1	AMW541228FUTC	2,380	C	
	60	1	AMW601228FUTC	2,410	C	
	34.75"H	36	1	AMW361235FUTA	1,640	A
		42	1	AMW421235FUTA	2,170	A
		48	1	AMW481235FUTA	2,190	A
		54	1	AMW541235FUTA	2,560	A
		60	1	AMW601235FUTA	2,590	A
		36	1	AMW361235FUTB	1,720	B
	42	1	AMW421235FUTB	2,270	B	
	48	1	AMW481235FUTB	2,290	B	
	54	1	AMW541235FUTB	2,700	B	
60	1	AMW601235FUTB	2,720	B		
36	1	AMW361235FUTC	1,850	C		
42	1	AMW421235FUTC	2,460	C		
48	1	AMW481235FUTC	2,490	C		
54	1	AMW541235FUTC	2,930	C		
60	1	AMW601235FUTC	2,960	C		
40.75"H	36	1	AMW361241FUTA	1,960	A	
	42	1	AMW421241FUTA	2,590	A	
	48	1	AMW481241FUTA	2,620	A	
	54	1	AMW541241FUTA	3,080	A	
	60	1	AMW601241FUTA	3,100	A	
	36	1	AMW361241FUTB	2,060	B	
42	1	AMW421241FUTB	2,720	B		
48	1	AMW481241FUTB	2,760	B		
54	1	AMW541241FUTB	3,230	B		
60	1	AMW601241FUTB	3,260	B		
36	1	AMW361241FUTC	2,220	C		
42	1	AMW421241FUTC	2,960	C		
48	1	AMW481241FUTC	2,980	C		
54	1	AMW541241FUTC	3,510	C		
60	1	AMW601241FUTC	3,540	C		

\*Note that top will be modified to fit the base if it is a tapering top. The wall end of the top will be 6" rectangle and then the top will start to taper.

# Media Wall

media wall		wall length	qty	wall model no.	list	laminate grade
6" deep media wall	72"H	36	1	AMW360672FWMA	2,610	A
		42	1	AMW420672FWMA	2,700	A
		48	1	AMW480672FWMA	2,730	A
		54	1	AMW540672FWMA	3,180	A
		60	1	AMW600672FWMA	3,520	A
		36	1	AMW360672FWMB	2,790	B
		42	1	AMW420672FWMB	2,900	B
		48	1	AMW480672FWMB	2,930	B
		54	1	AMW540672FWMB	3,410	B
		60	1	AMW600672FWMB	3,820	B
		36	1	AMW360672FWMC	3,060	C
		42	1	AMW420672FWMC	3,230	C
	48	1	AMW480672FWMC	3,270	C	
	54	1	AMW540672FWMC	3,800	C	
	60	1	AMW600672FWMC	4,210	C	
	84"H	36	1	AMW360684FWMA	3,360	A
		42	1	AMW420684FWMA	3,560	A
		48	1	AMW480684FWMA	3,590	A
		54	1	AMW540684FWMA	4,300	A
		60	1	AMW600684FWMA	4,630	A
		36	1	AMW360684FWMB	3,580	B
		42	1	AMW420684FWMB	3,810	B
		48	1	AMW480684FWMB	3,830	B
		54	1	AMW540684FWMB	4,580	B
60		1	AMW600684FWMB	4,980	B	
36		1	AMW360684FWMC	3,910	C	
42		1	AMW420684FWMC	4,210	C	
48	1	AMW480684FWMC	4,250	C		
54	1	AMW540684FWMC	5,070	C		
60	1	AMW600684FWMC	5,490	C		

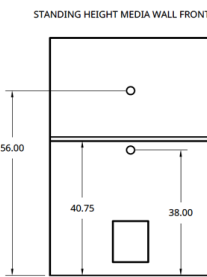
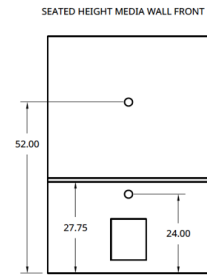
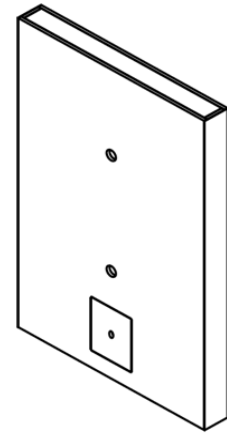

Please specify a back option:

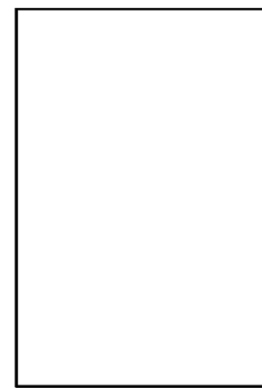

SOLID BACK  
model number **OMWSOBK** - \$0 list

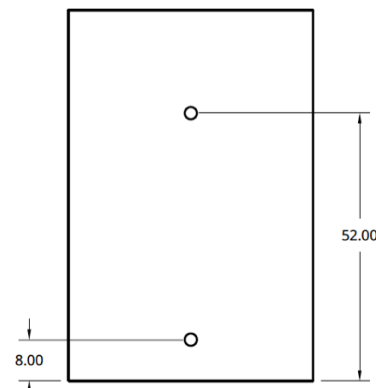

BACK WITH GROMMETS UPPER/LOWER  
model number **OMWGR2BK** - \$70 list

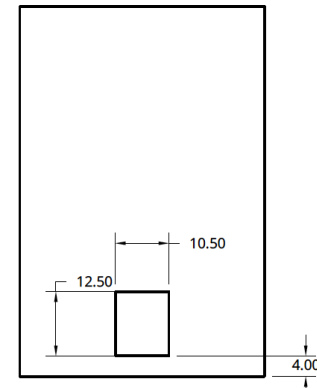



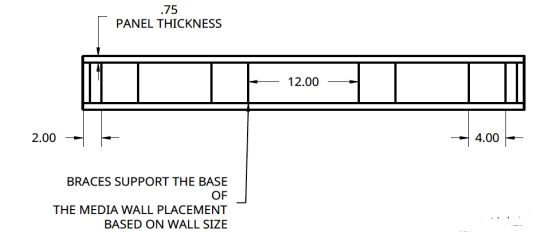
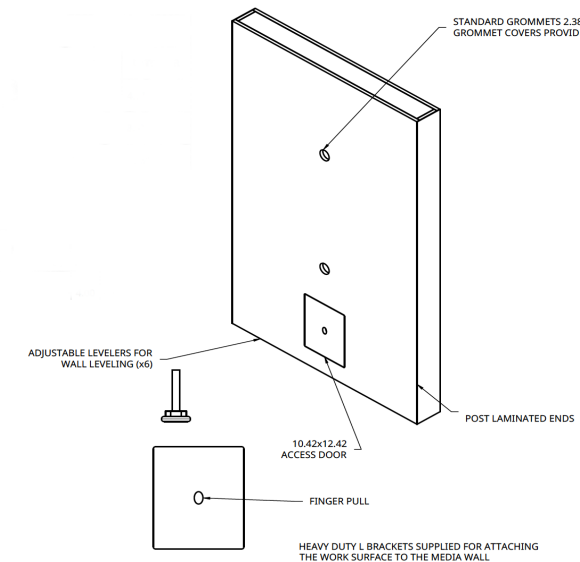
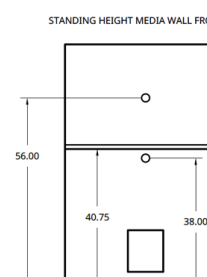
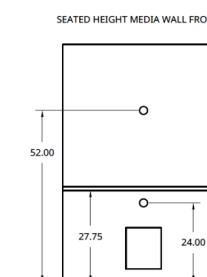
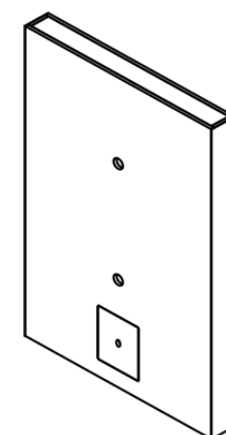

BACK WITH CUTOUT  
model number **OMWCO1BK** - \$60 list

media wall		wall length	qty	wall model no.	list	laminate grade
12" deep media wall	72"H	36	1	AMW361272FWMA	3,030	A
		42	1	AMW421272FWMA	3,230	A
		48	1	AMW481272FWMA	3,260	A
		54	1	AMW541272FWMA	3,810	A
		60	1	AMW601272FWMA	4,140	A
		36	1	AMW361272FWMB	3,250	B
		42	1	AMW421272FWMB	3,440	B
		48	1	AMW481272FWMB	3,480	B
		54	1	AMW541272FWMB	4,050	B
		60	1	AMW601272FWMB	4,460	B
		36	1	AMW361272FWMC	3,560	C
		42	1	AMW421272FWMC	3,870	C
	48	1	AMW481272FWMC	3,890	C	
	54	1	AMW541272FWMC	4,540	C	
	60	1	AMW601272FWMC	4,950	C	
	84"H	36	1	AMW361284FWMA	4,460	A
		42	1	AMW421284FWMA	4,920	A
		48	1	AMW481284FWMA	4,940	A
		54	1	AMW541284FWMA	5,950	A
		60	1	AMW601284FWMA	6,280	A
		36	1	AMW361284FWMB	4,730	B
		42	1	AMW421284FWMB	5,230	B
		48	1	AMW481284FWMB	5,250	B
		54	1	AMW541284FWMB	6,300	B
60		1	AMW601284FWMB	6,710	B	
36		1	AMW361284FWMC	5,210	C	
42		1	AMW421284FWMC	5,840	C	
48	1	AMW481284FWMC	5,870	C		
54	1	AMW541284FWMC	7,060	C		
60	1	AMW601284FWMC	7,470	C		



# bases







single base to use at the other end of a table with a under table media base or media wall

base	base dim.	qty	top depth	max top length when used with	single base model no.	list	finish	
 Keller single column T 27.75"H	26 x 27.75H	1	36	72	BTKEL36000SDGME	480	standard metal	
	33 x 27.75H	1	42	72	BTKEL42000SDGME	570	standard metal	
	38 x 27.75H	1	48	72	BTKEL48000SDGME	640	standard metal	
	26 x 27.75H	1	36	72	BTKEL36000SDGPO	550	polished	
	33 x 27.75H	1	42	72	BTKEL42000SDGPO	640	polished	
	38 x 27.75H	1	48	72	BTKEL48000SDGPO	700	polished	
	custom higher height (specify height)	26	1	36	72	BTKEL36000SHGME	560	standard metal
		33	1	42	72	BTKEL42000SHGME	650	standard metal
		38	1	48	72	BTKEL48000SHGME	720	standard metal
 Keller double column T 27.75"H	34 x 27.75H	1	48	72	BTKEL480002DGME	650	standard metal	
	40 x 27.75H	1	60	72	BTKEL600002DGME	720	standard metal	
	34 x 27.75H	1	48	72	BTKEL480002DGPO	790	polished	
	40 x 27.75H	1	60	72	BTKEL600002DGPO	860	polished	
	custom higher height (specify height)	34	1	48	72	BTKEL480002HGME	800	standard metal
		40	1	60	72	BTKEL600002HGME	870	standard metal
		34	1	48	72	BTKEL480002HGPO	950	polished
		40	1	60	72	BTKEL600002HGPO	1,010	polished
	 Ria single column T 27.75"H	26 x 27.75H	1	36	72	BTRIA36000SDGME	360	standard metal
33 x 27.75H		1	42	72	BTRIA42000SDGME	440	standard metal	
38 x 27.75H		1	48	72	BTRIA48000SDGME	510	standard metal	
26 x 27.75H		1	36	72	BTRIA36000SDGPO	430	polished	
33 x 27.75H		1	42	72	BTRIA42000SDGPO	510	polished	
38 x 27.75H		1	48	72	BTRIA48000SDGPO	570	polished	
custom higher height (specify height)		26	1	36	72	BTRIA36000SHGME	440	standard metal
		33	1	42	72	BTRIA42000SHGME	520	standard metal
		38	1	48	72	BTRIA48000SHGME	580	standard metal
 Ria double column T 27.75"H	26 x 27.75H	1	36	72	BTRIA36000SHGPO	510	polished	
	33 x 27.75H	1	42	72	BTRIA42000SHGPO	580	polished	
	38 x 27.75H	1	48	72	BTRIA48000SHGPO	650	polished	
	34 x 27.75H	1	48	72	BTRIA480002DGME	550	standard metal	
	40 x 27.75H	1	60	72	BTRIA600002DGME	590	standard metal	
	34 x 27.75H	1	48	72	BTRIA480002DGPO	690	polished	
	40 x 27.75H	1	60	72	BTRIA600002DGPO	740	polished	
	custom higher height (specify height)	34	1	48	72	BTRIA480002HGME	700	standard metal
		40	1	60	72	BTRIA600002HGME	750	standard metal
	34	1	48	72	BTRIA480002HGPO	850	polished	
	40	1	60	72	BTRIA600002HGPO	890	polished	

(ME) Standard metal powder coat finishes : Flat Black (FB), Furniture White (FW), Inner Tone (IT), Light Tone (LT), Medium Tone (MT), Metallic Silver (MS).

# bases

single base to use at the other end of a table with a under table media base or media wall

base	base dim.	qty	top depth	max top length when used with	single base model no.	list	finish	
 Bassa rectangular frame	solid metal panel	18 x 6 x 27.75	1	36	72	BFBAS36000REGSM	1,980	standard metal
		24 x 6 x 27.75	1	48	72	BFBAS48000REGSM	2,050	standard metal
		34 x 6 x 27.75	1	60	72	BFBAS60000REGSM	2,180	standard metal
	perforated metal panel	18 x 6 x 27.75	1	36	72	BFBAS36000REGPM	2,020	standard metal
		24 x 6 x 27.75	1	48	72	BFBAS48000REGPM	2,070	standard metal
		34 x 6 x 27.75	1	60	72	BFBAS60000REGPM	2,310	standard metal
 Bassa curved frame	solid metal panel	20 x 6 x 27.75	1	36	72	BFBAS36000CUGSM	1,980	standard metal
		26 x 6 x 27.75	1	48	72	BFBAS48000CUGSM	2,040	standard metal
		36 x 6 x 27.75	1	60	72	BFBAS60000CUGSM	2,260	standard metal
	perforated metal panel	20 x 6 x 27.75	1	36	72	BFBAS36000CUGPM	2,010	standard metal
		26 x 6 x 27.75	1	48	72	BFBAS48000CUGPM	2,060	standard metal
		36 x 6 x 27.75	1	60	72	BFBAS60000CUGPM	2,260	standard metal
 Moto 3" single column T 27.75"H	26 x 27.75H	1	36	72	BTMOT36000SDGME	450	standard metal	
	custom higher height (specify height)	26	1	36	72	BTMOT36000SHGME	530	standard metal
 Moto 3" double column T 27.75"H	26 x 27.75H	1	36	72	BTMOT360002DGME	630	standard metal	
	32 x 27.75H	1	42	72	BTMOT420002DGME	660	standard metal	
	36 x 27.75H	1	48	72	BTMOT480002DGME	720	standard metal	
	custom higher height (specify height)	26	1	36	72	BTMOT360002HGME	780	standard metal
		32	1	42	72	BTMOT420002HGME	810	standard metal
		36	1	48	72	BTMOT480002HGME	870	standard metal
 Zoey single column T 27.75"H	27 x 27.75H	1	36	72	BTZOE36000SDGME	320	standard metal	
	33 x 27.75H	1	42	72	BTZOE42000SDGME	340	standard metal	
 Zoey double column T 27.75"H	38 x 27.75H	1	48	72	BTZOE480002DGME	650	standard metal	
	47 x 27.75H	1	60	72	BTZOE600002DGME	720	standard metal	

(ME) Standard metal powder coat finishes : Flat Black (FB), Furniture White (FW), Inner Tone (IT), Light Tone (LT), Medium Tone (MT), Metallic Silver (MS).



\* Laminate panels are available for Bassa, email service@symphonytables.com for pricing.



# bases

single conference or media base

Lastra

base	base dim. W x D x H	qty	top depth	max top length when used with media wall	single base model no.	list	laminate grade		
Lastra 6" rectangle 	27.75"H	18 x 6 x 27.75	1	42	BLLAR4206D1GLA	680	A		
		24 x 6 x 27.75	1	48	BLLAR4806D1GLA	870	A		
		30 x 6 x 27.75	1	60	BLLAR6006D1GLA	1,010	A		
	40.75"H	18 x 6 x 27.75	1	42	72	BLLAR4206D1GLB	770	B	
		24 x 6 x 27.75	1	48	72	BLLAR4806D1GLB	900	B	
		30 x 6 x 27.75	1	60	72	BLLAR6006D1GLB	1,060	B	
		18 x 6 x 40.75	1	42	72	BLLAR4206D1GLC	910	C	
		24 x 6 x 40.75	1	48	72	BLLAR4806D1GLC	1,050	C	
		30 x 6 x 40.75	1	60	72	BLLAR6006D1GLC	1,230	C	
	Lastra 12" rectangle	27.75"H	18 x 12 x 27.75	1	42	BLLAR4212D1GLA	800	A	
			24 x 12 x 27.75	1	48	BLLAR4812D1GLA	910	A	
			30 x 12 x 27.75	1	60	BLLAR6012D1GLA	1,070	A	
		40.75"H	18 x 12 x 27.75	1	42	84	BLLAR4212D1GLB	850	B
			24 x 12 x 27.75	1	48	84	BLLAR4812D1GLB	950	B
			30 x 12 x 27.75	1	60	84	BLLAR6012D1GLB	1,120	B
18 x 12 x 40.75			1	42	84	BLLAR4212D1GLC	990	C	
24 x 12 x 40.75			1	48	84	BLLAR4812D1GLC	1,120	C	
30 x 12 x 40.75			1	60	84	BLLAR6012D1GLC	1,300	C	
Lastra square 		27.75"H	18 x 18 x 27.75	1	36	BLLAS36036D1GLA	1,130	A	
			20 x 20 x 27.75	1	42	BLLAS42042D1GLA	1,160	A	
			24 x 24 x 27.75	1	48	BLLAS48048D1GLA	1,180	A	
		40.75"H	30 x 30 x 27.75	1	54	96	BLLAS54054D1GLA	1,340	A
			36 x 36 x 27.75	1	60	102	BLLAS60060D1GLA	1,530	A
			18 x 18 x 40.75	1	36	84	BLLAS36036D1GLB	1,160	B
	20 x 20 x 40.75		1	42	84	BLLAS42042D1GLB	1,180	B	
	24 x 24 x 40.75		1	48	90	BLLAS48048D1GLB	1,200	B	
	30 x 30 x 40.75		1	54	96	BLLAS54054D1GLB	1,380	B	
	Lastra square	27.75"H	36 x 36 x 27.75	1	60	102	BLLAS60060D1GLA	1,530	A
			18 x 18 x 40.75	1	36	84	BLLAS36036D1GLC	1,350	C
			20 x 20 x 40.75	1	42	84	BLLAS42042D1GLC	1,380	C
		40.75"H	24 x 24 x 40.75	1	48	90	BLLAS48048D1GLC	1,420	C
			30 x 30 x 40.75	1	54	96	BLLAS54054D1GLC	1,610	C
			36 x 36 x 40.75	1	60	102	BLLAS60060D1GLC	1,820	C
18 x 18 x 27.75			1	36	84	BLLAS36036D1GLB	1,160	B	
20 x 20 x 27.75			1	42	84	BLLAS42042D1GLB	1,180	B	
24 x 24 x 27.75			1	48	90	BLLAS48048D1GLB	1,200	B	

\* Lastra rectangle and square interior base dimensions are 1.5" less than the "W x D" dimension listed for each base  
 \*\* the bottom of the Lastra base is open to the floor

# bases

media base for a round or square top

Lastra, Tambo

base	base dim. W x D x H	qty	top depth	max top length when used with media wall	single base model no.	list	laminate grade		
Lastra square 	40.75"H	18 x 18 x 40.75	1	30	BLLAS30030H1GLA	1,120	A		
		20 x 20 x 40.75	1	36	BLLAS36036H1GLA	1,250	A		
		24 x 24 x 40.75	1	42	BLLAS42042H1GLA	1,300	A		
	40.75"H	30 x 30 x 40.75	1	48	84	BLLAS48048H1GLA	1,570	A	
		36 x 36 x 40.75	1	54	90	BLLAS54054H1GLA	1,850	A	
		18 x 18 x 40.75	1	30	72	BLLAS30030H1GLB	1,250	B	
		20 x 20 x 40.75	1	36	72	BLLAS36036H1GLB	1,300	B	
		24 x 24 x 40.75	1	42	78	BLLAS42042H1GLB	1,320	B	
		30 x 30 x 40.75	1	48	84	BLLAS48048H1GLB	1,600	B	
	Tambo cylinder 	27.75"H	18 dia. x 27.75	1	36	84	BLTAM36036D1GLA	1,020	A
			20 dia. x 27.75	1	42	84	BLTAM42042D1GLA	1,210	A
			24 dia. x 27.75	1	48	90	BLTAM48048D1GLA	1,340	A
		40.75"H	30 dia. x 27.75	1	54	96	BLTAM54054D1GLA	1,600	A
			36 dia. x 27.75	1	60	102	BLTAM60060D1GLA	2,120	A
			18 dia. x 27.75	1	36	84	BLTAM36036D1GLB	1,130	B
20 dia. x 27.75			1	42	84	BLTAM42042D1GLB	1,340	B	
24 dia. x 27.75			1	48	90	BLTAM48048D1GLB	1,470	B	
30 dia. x 27.75			1	54	96	BLTAM54054D1GLB	1,750	B	
Tambo cylinder		27.75"H	36 dia. x 27.75	1	60	102	BLTAM60060D1GLB	2,330	B
			18 dia. x 40.75	1	30	72	BLTAM30030H1GLC	1,200	C
			20 dia. x 40.75	1	36	72	BLTAM36036H1GLC	1,220	C
		40.75"H	24 dia. x 40.75	1	42	78	BLTAM42042H1GLC	1,460	C
			30 dia. x 40.75	1	48	84	BLTAM48048H1GLC	1,620	C
			36 dia. x 40.75	1	54	96	BLTAM54054H1GLC	1,910	C
	18 dia. x 40.75		1	30	72	BLTAM30030H1GLA	1,200	A	
	20 dia. x 40.75		1	36	72	BLTAM36036H1GLA	1,430	A	
	24 dia. x 40.75		1	42	78	BLTAM42042H1GLA	1,580	A	
	Tambo cylinder	27.75"H	30 dia. x 40.75	1	48	84	BLTAM48048H1GLA	1,880	A
			36 dia. x 40.75	1	54	90	BLTAM54054H1GLA	2,490	A
			18 dia. x 40.75	1	30	72	BLTAM30030H1GLB	1,330	B
		40.75"H	20 dia. x 40.75	1	36	72	BLTAM36036H1GLB	1,570	B
			24 dia. x 40.75	1	42	78	BLTAM42042H1GLB	1,740	B
			30 dia. x 40.75	1	48	84	BLTAM48048H1GLB	2,060	B
36 dia. x 40.75			1	54	90	BLTAM54054H1GLB	2,730	B	
18 dia. x 40.75			1	30	72	BLTAM30030H1GLC	1,450	C	
20 dia. x 40.75			1	36	72	BLTAM36036H1GLC	1,730	C	
Tambo cylinder		27.75"H	24 dia. x 40.75	1	42	78	BLTAM42042H1GLC	1,900	C
			30 dia. x 40.75	1	48	84	BLTAM48048H1GLC	2,240	C
			36 dia. x 40.75	1	54	90	BLTAM54054H1GLC	2,980	C

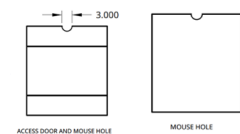

**Lastra hinged access door option:**

14.75"H hinged access door (1) for a seated height base, model # OBLASDH129 - \$190 list each  
 15.75"H hinged access door (1) for a standing height base, model # OBLASDH142 - \$210 list each

Lastra wire management mouse holes come on BOTH SIDES at the top / center of all bases in the set unless the base is specified with no wire management mouse holes, please indicate that you do not want mouse holes on one or both sides of the base in **bold face ALL CAPS** on your PO.

**Tambo laminate base options:**



10 x 10 side hinged curved access door for a cylinder base, model # OBLTAMWMD - \$610 list per door  
 50 LB ballast bag, model # OBLTAMBAL - \$180 list per bag

\* Tambo cylinder bases have 4 metal top plates to mount the base to the top, there is a 9.5" hole centered at the top and bottom of the base. Tambo bases do not come with wire management mouse holes.

# bases

single conference or media base



Lastra, Tambo

base	base dim. W x D x H	qty	max top support	single base model no.	list	laminata grade		
Lastra square 	27.75"H	18 x 18 x 27.75	1	36 x 36, 42 rd	BLLAS36036D1GLA	1,130	A	
		20 x 20 x 27.75	1	42 x 42, 48 rd	BLLAS42042D1GLA	1,160	A	
		24 x 24 x 27.75	1	48 x 48, 60 rd	BLLAS48048D1GLA	1,180	A	
		30 x 30 x 27.75	1	54 x 54, 66 rd	BLLAS54054D1GLA	1,340	A	
		36 x 36 x 27.75	1	60 x 60, 72 rd	BLLAS60060D1GLA	1,530	A	
	27.75"H	18 x 18 x 27.75	1	36 x 36, 42 rd	BLLAS36036D1GLB	1,160	B	
		20 x 20 x 27.75	1	42 x 42, 48 rd	BLLAS42042D1GLB	1,180	B	
		24 x 24 x 27.75	1	48 x 48, 60 rd	BLLAS48048D1GLB	1,200	B	
		30 x 30 x 27.75	1	54 x 54, 66 rd	BLLAS54054D1GLB	1,380	B	
		36 x 36 x 27.75	1	60 x 60, 72 rd	BLLAS60060D1GLB	1,550	B	
	27.75"H	18 x 18 x 27.75	1	36 x 36, 42 rd	BLLAS36036D1GLC	1,350	C	
		20 x 20 x 27.75	1	42 x 42, 48 rd	BLLAS42042D1GLC	1,380	C	
		24 x 24 x 27.75	1	48 x 48, 60 rd	BLLAS48048D1GLC	1,420	C	
		30 x 30 x 27.75	1	54 x 54, 66 rd	BLLAS54054D1GLC	1,610	C	
		36 x 36 x 27.75	1	60 x 60, 72 rd	BLLAS60060D1GLC	1,820	C	
	40.75"H	27.75"H	18 x 18 x 40.75	1	30 x 30, 36 rd	BLLAS36036H1GLA	1,230	A
			20 x 20 x 40.75	1	36 x 36, 42 rd	BLLAS42042H1GLA	1,250	A
			24 x 24 x 40.75	1	42 x 42, 48 rd	BLLAS48048H1GLA	1,300	A
			30 x 30 x 40.75	1	48 x 48, 54 rd	BLLAS54054H1GLA	1,570	A
			36 x 36 x 40.75	1	54 x 54, 60 rd	BLLAS60060H1GLA	1,850	A
40.75"H		18 x 18 x 40.75	1	30 x 30, 36 rd	BLLAS36036H1GLB	1,250	B	
		20 x 20 x 40.75	1	36 x 36, 42 rd	BLLAS42042H1GLB	1,300	B	
		24 x 24 x 40.75	1	42 x 42, 48 rd	BLLAS48048H1GLB	1,320	B	
		30 x 30 x 40.75	1	48 x 48, 54 rd	BLLAS54054H1GLB	1,600	B	
		36 x 36 x 40.75	1	54 x 54, 60 rd	BLLAS60060H1GLB	1,880	B	
40.75"H		18 x 18 x 40.75	1	30 x 30, 36 rd	BLLAS36036H1GLC	1,490	C	
		20 x 20 x 40.75	1	36 x 36, 42 rd	BLLAS42042H1GLC	1,520	C	
		24 x 24 x 40.75	1	42 x 42, 48 rd	BLLAS48048H1GLC	1,540	C	
		30 x 30 x 40.75	1	48 x 48, 54 rd	BLLAS54054H1GLC	1,880	C	
		36 x 36 x 40.75	1	54 x 54, 60 rd	BLLAS60060H1GLC	2,210	C	
Tambo cylinder 	27.75"H	18 dia. x 27.75	1	36 x 36, 42 rd	BLTAM36036D1GLA	1,020	A	
		20 dia. x 27.75	1	42 x 42, 48 rd	BLTAM42042D1GLA	1,210	A	
		24 dia. x 27.75	1	48 x 48, 60 rd	BLTAM48048D1GLA	1,340	A	
		30 dia. x 27.75	1	54 x 54, 66 rd	BLTAM54054D1GLA	1,600	A	
		36 dia. x 27.75	1	60 x 60, 72 rd	BLTAM60060D1GLA	2,120	A	
		18 dia. x 27.75	1	36 x 36, 42 rd	BLTAM36036D1GLB	1,130	B	
		20 dia. x 27.75	1	42 x 42, 48 rd	BLTAM42042D1GLB	1,340	B	
		24 dia. x 27.75	1	48 x 48, 60 rd	BLTAM48048D1GLB	1,470	B	
		30 dia. x 27.75	1	54 x 54, 66 rd	BLTAM54054D1GLB	1,750	B	
		36 dia. x 27.75	1	60 x 60, 72 rd	BLTAM60060D1GLB	2,330	B	
	40.75"H	18 dia. x 27.75	1	36 x 36, 42 rd	BLTAM36036D1GLC	1,220	C	
		20 dia. x 27.75	1	42 x 42, 48 rd	BLTAM42042D1GLC	1,460	C	
		24 dia. x 27.75	1	48 x 48, 60 rd	BLTAM48048D1GLC	1,620	C	
		30 dia. x 27.75	1	54 x 54, 66 rd	BLTAM54054D1GLC	1,910	C	
		36 dia. x 27.75	1	60 x 60, 72 rd	BLTAM60060D1GLC	2,540	C	
		18 dia. x 40.75	1	30 x 30, 36 rd	BLTAM30030H1GLA	1,200	A	
		20 dia. x 40.75	1	36 x 36, 42 rd	BLTAM36036H1GLA	1,430	A	
		24 dia. x 40.75	1	42 x 42, 48 rd	BLTAM42042H1GLA	1,580	A	
		30 dia. x 40.75	1	48 x 48, 54 rd	BLTAM48048H1GLA	1,880	A	
		36 dia. x 40.75	1	54 x 54, 60 rd	BLTAM54054H1GLA	2,490	A	
40.75"H	18 dia. x 40.75	1	30 x 30, 36 rd	BLTAM30030H1GLB	1,330	B		
	20 dia. x 40.75	1	36 x 36, 42 rd	BLTAM36036H1GLB	1,570	B		
	24 dia. x 40.75	1	42 x 42, 48 rd	BLTAM42042H1GLB	1,740	B		
	30 dia. x 40.75	1	48 x 48, 54 rd	BLTAM48048H1GLB	2,060	B		
	36 dia. x 40.75	1	54 x 54, 60 rd	BLTAM54054H1GLB	2,730	B		
	18 dia. x 40.75	1	30 x 30, 36 rd	BLTAM30030H1GLC	1,450	C		
	20 dia. x 40.75	1	36 x 36, 42 rd	BLTAM36036H1GLC	1,730	C		
	24 dia. x 40.75	1	42 x 42, 48 rd	BLTAM42042H1GLC	1,900	C		
	30 dia. x 40.75	1	48 x 48, 54 rd	BLTAM48048H1GLC	2,240	C		
	36 dia. x 40.75	1	54 x 54, 60 rd	BLTAM54054H1GLC	2,980	C		

# bases

media base for a round or square top

Keller, Ria

base	base dim. W x D x H	qty	max top support	single base model no.	list	glides	finish
Keller media base with perforated metal panels 	51 x 51 x 27.75	1	54 x 54, 60 rd	BMKEL540544DGME	3,300	adj glides	standard metal
	56 x 56 x 27.75	1	60 x 60, 72 rd	BMKEL600604DGME	3,360	adj glides	standard metal
	51 x 51 x 40.75	1	54 x 54, 60 rd	BMKEL540544BGME	3,420	adj glides	standard metal
	56 x 56 x 40.75	1	60 x 60, 72 rd	BMKEL600604BGME	3,510	adj glides	standard metal
Ria media base with perforated metal panels 	51 x 51 x 27.75	1	54 x 54, 60 rd	BMRIA540544DGME	3,100	adj glides	standard metal
	56 x 56 x 27.75	1	60 x 60, 72 rd	BMRIA600604DGME	3,120	adj glides	standard metal
	51 x 51 x 40.75	1	54 x 54, 60 rd	BMRIA540544BGME	3,470	adj glides	standard metal
	56 x 56 x 40.75	1	60 x 60, 72 rd	BMRIA600604BGME	3,500	adj glides	standard metal

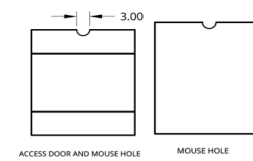

**Lastra hinged access door option:**

14.75"H hinged access door (1) for a seated height base, model # **OBLASDH129** - \$170 list each  
 15.75"H hinged access door (1) for a standing height base, model # **OBLASDH142** - \$190 list each

Lastra wire management mouse holes come on BOTH SIDES at the top / center of all bases in the set unless the base is specified with no wire management mouse holes, please indicate that you do not want mouse holes on one or both sides of the base in **bold face ALL CAPS** on your PO.

\* Lastra rectangle and square interior base dimensions are 1.5" less than the "W x D" dimension listed for each base  
 \*\* the bottom of the Lastra base is open to the floor

**Tambo laminate base option:**

10 x 10 side hinged curved access door for a cylinder base,  
 model # **OBLTAMWMD** - \$610 list per door

50 LB ballast bag,  
 model # **OBLTAMBAL** - \$180 list per bag\*\*

\*\* Note that ballast bags are required for single Tambo bases being used with round or square tops. 18", 24" and 24" diameter bases require 1 bag per base. 30" and 36 inch bases require 2 bags per base.

\* Tambo cylinder bases have 4 metal top plates to mount the base to the top, there is a 9.5" hole centered at the top and bottom of the base. Tambo bases do not come with wire management mouse holes.

**(ME) Standard metal powder coat finishes (Keller and Ria)**

Flat Black (FB), Furniture White (FW), Inner Tone (IT), Light Tone (LT), Medium Tone (MT), Metallic Silver (MS).

\* polished finish is not available for Keller or Ria Media bases with perforated metal panels

Ria and Keller bases feature a 10.5 x 10.5 " enclosure with the perforated metal panels.

**Media Table Wall Support Bracket**

Shall be used in peninsula applications for top sizes up to 48 x 60 for the 51 x 51 base or tops up to 60 x 72 with the 56 x 56 inch Ria or Keller Media base. Wall bracket must be secured to the wall studs with 5/16 diameter screws, dealer/installer shall provide the hardware. Finish is Furniture White

Use the 33-7/8" long bracket for tops that are 42" - 48" where the top connects to the wall,  
 model # **OBMWB48**, \$350 list each

Use the 50" long bracket for tops that are 54" - 60" where the top connects to the wall,  
 model # **OBMWB60**, \$450 list each

# bases

## Keller V with stretcher

base	base qty + dim.	stretcher	max top support	base model no.	list	glides or casters	finish
Keller V with stretcher (27.75"H)	(2) 17.5	(1) 40	24 x 60	BVKE224060SDGME	1,090	adj glides	standard metal
	(2) 23	(1) 40	30 x 60	BVKE230060SDGME	1,160	adj glides	standard metal
	(2) 29	(1) 34	36 x 60	BVKE236060SDGME	1,330	adj glides	standard metal
	(2) 33.5	(1) 34	48 x 60	BVKE248060SDGME	1,490	adj glides	standard metal
	(2) 17.5	(1) 50	24 x 72	BVKE224072SDGME	1,140	adj glides	standard metal
	(2) 23	(1) 50	30 x 72	BVKE230072SDGME	1,200	adj glides	standard metal
	(2) 29	(1) 40	36 x 72	BVKE236072SDGME	1,340	adj glides	standard metal
	(2) 33.5	(1) 40	48 x 72	BVKE248072SDGME	1,500	adj glides	standard metal
	(2) 29	(1) 50	36 x 84	BVKE236084SDGME	1,390	adj glides	standard metal
	(2) 33.5	(1) 50	48 x 84	BVKE248084SDGME	1,540	adj glides	standard metal
	(2) 29	(1) 58	36 x 96	BVKE236096SDGME	1,460	adj glides	standard metal
	(2) 33.5	(1) 58	48 x 96	BVKE248096SDGME	1,610	adj glides	standard metal
	(2) 17.5	(1) 40	24 x 60	BVKE224060SDCME	1,180	2" black locking casters	standard metal
	(2) 23	(1) 40	30 x 60	BVKE230060SDCME	1,240	2" black locking casters	standard metal
	(2) 29	(1) 34	36 x 60	BVKE236060SDCME	1,420	2" black locking casters	standard metal
	(2) 33.5	(1) 34	48 x 60	BVKE248060SDCME	1,570	2" black locking casters	standard metal
	(2) 17.5	(1) 50	24 x 72	BVKE224072SDCME	1,230	2" black locking casters	standard metal
	(2) 23	(1) 50	30 x 72	BVKE230072SDCME	1,290	2" black locking casters	standard metal
	(2) 29	(1) 40	36 x 72	BVKE236072SDCME	1,430	2" black locking casters	standard metal
	(2) 33.5	(1) 40	48 x 72	BVKE248072SDCME	1,580	2" black locking casters	standard metal
	(2) 29	(1) 50	36 x 84	BVKE236084SDCME	1,470	2" black locking casters	standard metal
	(2) 33.5	(1) 50	48 x 84	BVKE248084SDCME	1,630	2" black locking casters	standard metal
	(2) 29	(1) 58	36 x 96	BVKE236096SDCME	1,550	2" black locking casters	standard metal
	(2) 33.5	(1) 58	48 x 96	BVKE248096SDCME	1,690	2" black locking casters	standard metal
	(2) 17.5	(1) 40	24 x 60	BVKE224060SDGPO	1,420	adj glides	polished
	(2) 23	(1) 40	30 x 60	BVKE230060SDGPO	1,490	adj glides	polished
	(2) 29	(1) 34	36 x 60	BVKE236060SDGPO	1,660	adj glides	polished
	(2) 33.5	(1) 34	48 x 60	BVKE248060SDGPO	1,820	adj glides	polished
	(2) 17.5	(1) 50	24 x 72	BVKE224072SDGPO	1,470	adj glides	polished
	(2) 23	(1) 50	30 x 72	BVKE230072SDGPO	1,530	adj glides	polished
	(2) 29	(1) 40	36 x 72	BVKE236072SDGPO	1,670	adj glides	polished
	(2) 33.5	(1) 40	48 x 72	BVKE248072SDGPO	1,830	adj glides	polished
	(2) 29	(1) 50	36 x 84	BVKE236084SDGPO	1,720	adj glides	polished
	(2) 33.5	(1) 50	48 x 84	BVKE248084SDGPO	1,870	adj glides	polished
	(2) 29	(1) 58	36 x 96	BVKE236096SDGPO	1,790	adj glides	polished
	(2) 33.5	(1) 58	48 x 96	BVKE248096SDGPO	1,940	adj glides	polished
	(2) 17.5	(1) 40	24 x 60	BVKE224060SDCPO	1,510	2" black locking casters	polished
	(2) 23	(1) 40	30 x 60	BVKE230060SDCPO	1,570	2" black locking casters	polished
	(2) 29	(1) 34	36 x 60	BVKE236060SDCPO	1,750	2" black locking casters	polished
	(2) 33.5	(1) 34	48 x 60	BVKE248060SDCPO	1,900	2" black locking casters	polished
	(2) 17.5	(1) 50	24 x 72	BVKE224072SDCPO	1,560	2" black locking casters	polished
	(2) 23	(1) 50	30 x 72	BVKE230072SDCPO	1,620	2" black locking casters	polished
	(2) 29	(1) 40	36 x 72	BVKE236072SDCPO	1,760	2" black locking casters	polished
	(2) 33.5	(1) 40	48 x 72	BVKE248072SDCPO	1,910	2" black locking casters	polished
	(2) 29	(1) 50	36 x 84	BVKE236084SDCPO	1,800	2" black locking casters	polished
	(2) 33.5	(1) 50	48 x 84	BVKE248084SDCPO	1,960	2" black locking casters	polished
	(2) 29	(1) 58	36 x 96	BVKE236096SDCPO	1,880	2" black locking casters	polished
	(2) 33.5	(1) 58	48 x 96	BVKE248096SDCPO	2,020	2" black locking casters	polished



**Casters (C)\***  
2" black dual wheel locking  
\*only available on fixed V base with stretchers - casters are not available on double Y bases with stretchers

**Standard metal powder coat finishes (ME)**  
Black Wrinkle, Chateau Brown Wrinkle, Flat Black, Furniture White, Inner Tone, Light Tone, Medium Tone and Metallic Silver

**Premium Polished Finishes (EQ)**  
polished aluminum/steel

# bases

## Keller YY with TT base(s) with stretchers

base	base qty + dim.	stretchers	max top support	base model no.	list	glides	finish
Keller YY w/ center TT base and stretchers (27.75"H)	(2) 32YY (1) 34TT	(4) 34	42 x 108	BYKE242108SDGME	3,600	adj glides	standard metal
	(2) 38YY (1) 40TT	(4) 34	48 x 108	BYKE248108SDGME	3,690	adj glides	standard metal
	(2) 41YY (1) 40TT	(4) 34	60 x 108	BYKE260108SDGME	3,720	adj glides	standard metal
	(2) 32YY (1) 34TT	(4) 40	42 x 120	BYKE242120SDGME	3,650	adj glides	standard metal
	(2) 38YY (1) 40TT	(4) 40	48 x 120	BYKE248120SDGME	3,730	adj glides	standard metal
	(2) 41YY (1) 40TT	(4) 40	60 x 120	BYKE260120SDGME	3,770	adj glides	standard metal
	(2) 32YY (1) 34TT	(4) 50	42 x 144	BYKE242144SDGME	3,720	adj glides	standard metal
	(2) 38YY (1) 40TT	(4) 50	48 x 144	BYKE248144SDGME	3,810	adj glides	standard metal
	(2) 41YY (1) 40TT	(4) 50	60 x 144	BYKE260144SDGME	3,840	adj glides	standard metal
	(2) 32YY (1) 34TT	(4) 34	42 x 108	BYKE242108SDGPO	4,520	adj glides	polished
	(2) 38YY (1) 40TT	(4) 34	48 x 108	BYKE248108SDGPO	4,610	adj glides	polished
	(2) 41YY (1) 40TT	(4) 34	60 x 108	BYKE260108SDGPO	4,640	adj glides	polished
	(2) 32YY (1) 34TT	(4) 40	42 x 120	BYKE242120SDGPO	4,580	adj glides	polished
	(2) 38YY (1) 40TT	(4) 40	48 x 120	BYKE248120SDGPO	4,650	adj glides	polished
	(2) 41YY (1) 40TT	(4) 40	60 x 120	BYKE260120SDGPO	4,700	adj glides	polished
	(2) 32YY (1) 34TT	(4) 50	42 x 144	BYKE242144SDGPO	4,640	adj glides	polished
	(2) 38YY (1) 40TT	(4) 50	48 x 144	BYKE248144SDGPO	4,730	adj glides	polished
	(2) 41YY (1) 40TT	(4) 50	60 x 144	BYKE260144SDGPO	4,760	adj glides	polished
Keller YY w/ center TT bases and stretchers (27.75"H)	(2) 32YY (2) 34TT	(6) 40	42 x 168	BYKE242168SDGME	5,020	adj glides	standard metal
	(2) 38YY (2) 40TT	(6) 40	48 x 168	BYKE248168SDGME	5,130	adj glides	standard metal
	(2) 41YY (2) 40TT	(6) 40	60 x 168	BYKE260168SDGME	5,160	adj glides	standard metal
	(2) 32YY (2) 34TT	(6) 50	42 x 192	BYKE242192SDGME	5,120	adj glides	standard metal
	(2) 38YY (2) 40TT	(6) 50	48 x 192	BYKE248192SDGME	5,240	adj glides	standard metal
	(2) 41YY (2) 40TT	(6) 50	60 x 192	BYKE260192SDGME	5,270	adj glides	standard metal
	(2) 32YY (2) 34TT	(6) 40	42 x 168	BYKE242168SDGPO	6,330	adj glides	polished
	(2) 38YY (2) 40TT	(6) 40	48 x 168	BYKE248168SDGPO	6,440	adj glides	polished
	(2) 41YY (2) 40TT	(6) 40	60 x 168	BYKE260168SDGPO	6,470	adj glides	polished
	(2) 32YY (2) 34TT	(6) 50	42 x 192	BYKE242192SDGPO	6,420	adj glides	polished
	(2) 38YY (2) 40TT	(6) 50	48 x 192	BYKE248192SDGPO	6,550	adj glides	polished
	(2) 41YY (2) 40TT	(6) 50	60 x 192	BYKE260192SDGPO	6,580	adj glides	polished

**Standard metal powder coat finishes (ME)**

Black Wrinkle, Chateau Brown Wrinkle, Flat Black, Furniture White, Inner Tone, Light Tone, Medium Tone and Metallic Silver





# bases

## Ria V with stretcher

base	base qty + dim.	stretcher	max top support	base model no.	list	glides or casters	finish
	(2) 17.5	40	24 x 60	BVRI224060SDGME	920	adj glides	standard metal
	(2) 23	40	30 x 60	BVRI230060SDGME	960	adj glides	standard metal
	(2) 29	34	36 x 60	BVRI236060SDGME	1,140	adj glides	standard metal
	(2) 33.5	34	48 x 60	BVRI248060SDGME	1,250	adj glides	standard metal
	(2) 17.5	50	24 x 72	BVRI224072SDGME	990	adj glides	standard metal
	(2) 23	50	30 x 72	BVRI230072SDGME	1,020	adj glides	standard metal
	(2) 29	40	36 x 72	BVRI236072SDGME	1,160	adj glides	standard metal
	(2) 33.5	40	48 x 72	BVRI248072SDGME	1,280	adj glides	standard metal
	(2) 23	64	30 x 84	BVRI230084SDGME	1,090	adj glides	standard metal
	(2) 29	50	36 x 84	BVRI236084SDGME	1,220	adj glides	standard metal
	(2) 33.5	50	48 x 84	BVRI248084SDGME	1,330	adj glides	standard metal
	(2) 23	76	30 x 96	BVRI230096SDGME	1,170	adj glides	standard metal
(2) 29	58	36 x 96	BVRI236096SDGME	1,280	adj glides	standard metal	
(2) 33.5	58	48 x 96	BVRI248096SDGME	1,390	adj glides	standard metal	
(2) 17.5	40	24 x 60	BVRI224060SDCME	1,010	2" black locking casters	standard metal	
(2) 23	40	30 x 60	BVRI230060SDCME	1,050	2" black locking casters	standard metal	
(2) 29	34	36 x 60	BVRI236060SDCME	1,230	2" black locking casters	standard metal	
(2) 33.5	34	48 x 60	BVRI248060SDCME	1,340	2" black locking casters	standard metal	
(2) 17.5	50	24 x 72	BVRI224072SDCME	1,080	2" black locking casters	standard metal	
(2) 23	50	30 x 72	BVRI230072SDCME	1,110	2" black locking casters	standard metal	
(2) 29	40	36 x 72	BVRI236072SDCME	1,240	2" black locking casters	standard metal	
(2) 33.5	40	48 x 72	BVRI248072SDCME	1,360	2" black locking casters	standard metal	
(2) 23	64	30 x 84	BVRI230084SDCME	1,180	2" black locking casters	standard metal	
(2) 29	50	36 x 84	BVRI236084SDCME	1,310	2" black locking casters	standard metal	
(2) 33.5	50	48 x 84	BVRI248084SDCME	1,420	2" black locking casters	standard metal	
(2) 23	76	30 x 96	BVRI230096SDCME	1,250	2" black locking casters	standard metal	
(2) 29	58	36 x 96	BVRI236096SDCME	1,360	2" black locking casters	standard metal	
(2) 33.5	58	48 x 96	BVRI248096SDCME	1,470	2" black locking casters	standard metal	
(2) 17.5	40	24 x 60	BVRI224060SDGPO	1,250	adj glides	polished	
(2) 23	40	30 x 60	BVRI230060SDGPO	1,290	adj glides	polished	
(2) 29	34	36 x 60	BVRI236060SDGPO	1,470	adj glides	polished	
(2) 33.5	34	48 x 60	BVRI248060SDGPO	1,580	adj glides	polished	
(2) 17.5	50	24 x 72	BVRI224072SDGPO	1,320	adj glides	polished	
(2) 23	50	30 x 72	BVRI230072SDGPO	1,350	adj glides	polished	
(2) 29	40	36 x 72	BVRI236072SDGPO	1,490	adj glides	polished	
(2) 33.5	40	48 x 72	BVRI248072SDGPO	1,610	adj glides	polished	
(2) 23	64	30 x 84	BVRI230084SDGPO	1,420	adj glides	polished	
(2) 29	50	36 x 84	BVRI236084SDGPO	1,550	adj glides	polished	
(2) 33.5	50	48 x 84	BVRI248084SDGPO	1,660	adj glides	polished	
(2) 23	76	30 x 96	BVRI230096SDGPO	1,500	adj glides	polished	
(2) 29	58	36 x 96	BVRI236096SDGPO	1,610	adj glides	polished	
(2) 33.5	58	48 x 96	BVRI248096SDGPO	1,720	adj glides	polished	
(2) 17.5	40	24 x 60	BVRI224060SDCPO	1,340	2" black locking casters	polished	
(2) 23	40	30 x 60	BVRI230060SDCPO	1,380	2" black locking casters	polished	
(2) 29	34	36 x 60	BVRI236060SDCPO	1,560	2" black locking casters	polished	
(2) 33.5	34	48 x 60	BVRI248060SDCPO	1,670	2" black locking casters	polished	
(2) 17.5	50	24 x 72	BVRI224072SDCPO	1,410	2" black locking casters	polished	
(2) 23	50	30 x 72	BVRI230072SDCPO	1,440	2" black locking casters	polished	
(2) 29	40	36 x 72	BVRI236072SDCPO	1,570	2" black locking casters	polished	
(2) 33.5	40	48 x 72	BVRI248072SDCPO	1,690	2" black locking casters	polished	
(2) 23	64	30 x 84	BVRI230084SDCPO	1,510	2" black locking casters	polished	
(2) 29	50	36 x 84	BVRI236084SDCPO	1,640	2" black locking casters	polished	
(2) 33.5	50	48 x 84	BVRI248084SDCPO	1,750	2" black locking casters	polished	
(2) 23	76	30 x 96	BVRI230096SDCPO	1,580	2" black locking casters	polished	
(2) 29	58	36 x 96	BVRI236096SDCPO	1,690	2" black locking casters	polished	
(2) 33.5	58	48 x 96	BVRI248096SDCPO	1,800	2" black locking casters	polished	

# bases

## Ria YY with TT base(s) with stretchers

base	base qty + dim.	stretchers	max top support	base model no.	list	glides	finish
	(2) 32YY (1) 34TT	(4) 34	42 x 108	BYRI242108SDGME	3,120	adj glides	standard metal
	(2) 38YY (1) 40TT	(4) 34	48 x 108	BYRI248108SDGME	3,200	adj glides	standard metal
	(2) 41YY (1) 40TT	(4) 34	60 x 108	BYRI260108SDGME	3,230	adj glides	standard metal
	(2) 32YY (1) 34TT	(4) 40	42 x 120	BYRI242120SDGME	3,170	adj glides	standard metal
	(2) 38YY (1) 40TT	(4) 40	48 x 120	BYRI248120SDGME	3,260	adj glides	standard metal
	(2) 41YY (1) 40TT	(4) 40	60 x 120	BYRI260120SDGME	3,290	adj glides	standard metal
	(2) 32YY (1) 34TT	(4) 50	42 x 144	BYRI242144SDGME	3,310	adj glides	standard metal
	(2) 38YY (1) 40TT	(4) 50	48 x 144	BYRI248144SDGME	3,400	adj glides	standard metal
	(2) 41YY (1) 40TT	(4) 50	60 x 144	BYRI260144SDGME	3,430	adj glides	standard metal
	(2) 32YY (1) 34TT	(4) 34	42 x 108	BYRI242108SDGPO	4,050	adj glides	polished
	(2) 38YY (1) 40TT	(4) 34	48 x 108	BYRI248108SDGPO	4,130	adj glides	polished
	(2) 41YY (1) 40TT	(4) 34	60 x 108	BYRI260108SDGPO	4,160	adj glides	polished
(2) 32YY (1) 34TT	(4) 40	42 x 120	BYRI242120SDGPO	4,090	adj glides	polished	
(2) 38YY (1) 40TT	(4) 40	48 x 120	BYRI248120SDGPO	4,180	adj glides	polished	
(2) 41YY (1) 40TT	(4) 40	60 x 120	BYRI260120SDGPO	4,210	adj glides	polished	
(2) 32YY (1) 34TT	(4) 50	42 x 144	BYRI242144SDGPO	4,240	adj glides	polished	
(2) 38YY (1) 40TT	(4) 50	48 x 144	BYRI248144SDGPO	4,320	adj glides	polished	
(2) 41YY (1) 40TT	(4) 50	60 x 144	BYRI260144SDGPO	4,360	adj glides	polished	
	(2) 32YY (2) 34TT	(6) 40	42 x 168	BYRI242168SDGME	4,320	adj glides	standard metal
	(2) 38YY (2) 40TT	(6) 40	48 x 168	BYRI248168SDGME	4,430	adj glides	standard metal
	(2) 41YY (2) 40TT	(6) 40	60 x 168	BYRI260168SDGME	4,470	adj glides	standard metal
	(2) 32YY (2) 34TT	(6) 50	42 x 192	BYRI242192SDGME	4,530	adj glides	standard metal
	(2) 38YY (2) 40TT	(6) 50	48 x 192	BYRI248192SDGME	4,650	adj glides	standard metal
	(2) 41YY (2) 40TT	(6) 50	60 x 192	BYRI260192SDGME	4,690	adj glides	standard metal
	(2) 32YY (2) 34TT	(6) 40	42 x 168	BYRI242168SDGPO	5,630	adj glides	polished
	(2) 38YY (2) 40TT	(6) 40	48 x 168	BYRI248168SDGPO	5,740	adj glides	polished
	(2) 41YY (2) 40TT	(6) 40	60 x 168	BYRI260168SDGPO	5,780	adj glides	polished
	(2) 32YY (2) 34TT	(6) 50	42 x 192	BYRI242192SDGPO	5,840	adj glides	polished
	(2) 38YY (2) 40TT	(6) 50	48 x 192	BYRI248192SDGPO	5,960	adj glides	polished
	(2) 41YY (2) 40TT	(6) 50	60 x 192	BYRI260192SDGPO	6,000	adj glides	polished

\* max top support reflects a rectangle shaped top



**Casters (C)**

2" black dual wheel locking (only available on Ria V bases with single stretcher)

**Standard metal powder coat finishes (ME)**

Black Wrinkle, Chateau Brown Wrinkle, Flat Black, Furniture White, Inner Tone, Light Tone, Medium Tone and Metallic Silver

**Premium Polished Finishes (PQ)**

Polished Aluminum/Steel

# bases

## Zoey conference bases

For complete model number:

1. Insert height selection :

**D** dining height 27.75"H- see below chart for pricing

**B** bar height 40.75"H - see below chart for pricing

version	end base	middle	stretcher(s)	max top	base set model no.	dining	bar
Zoey Y base with stretcher(s) for use with a <b>rectangle top</b> (top is not included in the price)							
single stretcher	(2) 19	n/a	(1) 16	24 x 48	BYZO224048RES - G ME	1,080	n/a
	(2) 19	n/a	(1) 29	24 x 60	BYZO224060RES - G ME	1,100	1,280
	(2) 19	n/a	(1) 39	24 x 72	BYZO224072RES - G ME	1,130	1,300
	(2) 24	n/a	(1) 12	30 x 48	BYZO230048RES - G ME	1,090	1,250
	(2) 24	n/a	(1) 24	30 x 60	BYZO230060RES - G ME	1,130	1,290
	(2) 24	n/a	(1) 35	30 x 72	BYZO230072RES - G ME	1,140	1,310
	(2) 24	n/a	(1) 24	36 x 60	BYZO236060RES - G ME	1,280	1,440
	(2) 24	n/a	(1) 29	36 x 66	BYZO236066RES - G ME	1,290	1,450
	(2) 24	n/a	(1) 35	36 x 72	BYZO236072RES - G ME	1,300	1,460
	(2) 24	n/a	(1) 47	36 x 84	BYZO236084RES - G ME	1,350	1,510
	(2) 24	n/a	(1) 58	36 x 96	BYZO236096RES - G ME	1,400	1,570
	(2) 24	n/a	(1) 24	42 x 60	BYZO242060RES - G ME	1,280	1,440
	(2) 24	n/a	(1) 35	42 x 72	BYZO242072RES - G ME	1,300	1,460
	(2) 24	n/a	(1) 47	42 x 84	BYZO242084RES - G ME	1,350	1,510
(2) 24	n/a	(1) 58	42 x 96	BYZO242096RES - G ME	1,400	1,570	
double stretcher	(2) 35	n/a	(2) 24	48 x 60	BYZO248060RED - G ME	1,900	2,010
	(2) 35	n/a	(2) 35	48 x 72	BYZO248072RED - G ME	1,940	2,040
	(2) 35	n/a	(2) 47	48 x 84	BYZO248084RED - G ME	2,020	2,280
	(2) 35	n/a	(2) 58	48 x 96	BYZO248096RED - G ME	2,110	2,380
	(2) 35	(1) 38	(4) 39	48 x 120	BYZO248120RED - G ME	3,110	n/a
	(2) 35	(1) 38	(4) 52	48 x 144	BYZO248144RED - G ME	3,250	n/a
	(2) 40	n/a	(2) 24	54 x 60	BYZO254060RED - G ME	1,930	2,190
	(2) 40	n/a	(2) 35	54 x 72	BYZO254072RED - G ME	1,960	2,220
	(2) 40	n/a	(2) 47	54 x 84	BYZO254084RED - G ME	2,050	2,310
	(2) 40	n/a	(2) 52	54 x 96	BYZO254096RED - G ME	2,070	2,340
	(2) 40	(1) 42	(4) 39	54 x 120	BYZO254120RED - G ME	3,150	n/a
	(2) 40	(1) 42	(4) 52	54 x 144	BYZO254144RED - G ME	3,280	n/a
	(2) 44	n/a	(2) 29	60 x 66	BYZO260066RED - G ME	1,970	2,230
	(2) 44	n/a	(2) 35	60 x 72	BYZO260072RED - G ME	1,970	2,240
(2) 44	n/a	(2) 47	60 x 84	BYZO260084RED - G ME	2,070	2,330	
(2) 44	n/a	(2) 58	60 x 96	BYZO260096RED - G ME	2,170	2,420	
(2) 44	(1) 47	(4) 39	60 x 120	BYZO260120RED - G ME	3,180	n/a	
(2) 44	(1) 47	(4) 52	60 x 144	BYZO260144RED - G ME	3,300	n/a	

Standard metal powder coat finishes (ME)

Flat Black, Furniture White, Inner Tone, Light Tone, Medium Tone and Metallic Silver

# bases

## Zoey conference bases

For complete model number:

1. Insert height selection :

**D** dining height 27.75"H- see below chart for pricing

**B** bar height 40.75"H - see below chart for pricing

version	end base	middle	stretcher(s)	max top	base set model no.	dining	bar
Zoey Y base with stretcher(s) for use with a <b>Bullet Media top</b> (top is not included in the price)							
single stretcher	(2) 24	n/a	(1) 35	36 x 72	BYZO236072BUS - G ME	1,300	1,460
	(2) 24	n/a	(1) 24	42 x 60	BYZO242060BUS - G ME	1,280	1,440
	(2) 24	n/a	(1) 35	42 x 72	BYZO242072BUS - G ME	1,300	1,460
	(2) 24	n/a	(1) 47	42 x 84	BYZO242084BUS - G ME	1,350	1,510
	(2) 24	n/a	(1) 58	42 x 96	BYZO242096BUS - G ME	1,400	1,570
double stretcher	(2) 35	n/a	(2) 24	48 x 60	BYZO248060BUD - G ME	1,870	2,120
	(2) 35	n/a	(2) 35	48 x 72	BYZO248072BUD - G ME	1,930	2,190
	(2) 35	n/a	(2) 47	48 x 84	BYZO248084BUD - G ME	1,960	2,220
	(2) 35	n/a	(2) 58	48 x 96	BYZO248096BUD - G ME	2,060	2,320
	(2) 40	n/a	(2) 24	54 x 60	BYZO254060BUD - G ME	1,890	2,150
	(2) 40	n/a	(2) 35	54 x 72	BYZO254072BUD - G ME	1,950	2,210
	(2) 40	n/a	(2) 47	54 x 84	BYZO254084BUD - G ME	1,980	2,240
	(2) 40	n/a	(2) 52	54 x 96	BYZO254096BUD - G ME	2,070	2,340
	(2) 44	n/a	(2) 29	60 x 66	BYZO260066BUD - G ME	1,950	2,210
	(2) 44	n/a	(2) 35	60 x 72	BYZO260072BUD - G ME	1,970	2,230
	(2) 44	n/a	(2) 47	60 x 84	BYZO260084BUD - G ME	1,990	2,270
(2) 44	n/a	(2) 58	60 x 96	BYZO260096BUD - G ME	2,090	2,350	
Zoey Y base with stretcher(s) for use with a <b>Half Arc End Rectangle top</b> (top is not included in the price)							
single stretcher	(2) 24	n/a	(1) 35	36 x 72	BYZO236072HAS - G ME	1,300	1,460
	(2) 24	n/a	(1) 24	42 x 60	BYZO242060HAS - G ME	1,280	1,440
	(2) 24	n/a	(1) 35	42 x 72	BYZO242072HAS - G ME	1,300	1,460
	(2) 24	n/a	(1) 47	42 x 84	BYZO242084HAS - G ME	1,350	1,510
double stretcher	(2) 35	n/a	(2) 24	48 x 60	BYZO248060HAD - G ME	1,870	2,120
	(2) 35	n/a	(2) 35	48 x 72	BYZO248072HAD - G ME	1,930	2,190
	(2) 35	n/a	(2) 47	48 x 84	BYZO248084HAD - G ME	1,960	2,220
	(2) 35	n/a	(2) 58	48 x 96	BYZO248096HAD - G ME	2,060	2,320
	(2) 40	n/a	(2) 24	54 x 60	BYZO254060HAD - G ME	1,890	2,150
	(2) 40	n/a	(2) 35	54 x 72	BYZO254072HAD - G ME	1,950	2,210
	(2) 40	n/a	(2) 47	54 x 84	BYZO254084HAD - G ME	1,980	2,240
	(2) 40	n/a	(2) 52	54 x 96	BYZO254096HAD - G ME	2,070	2,340
	(2) 44	n/a	(2) 29	60 x 66	BYZO260066HAD - G ME	1,950	2,210
	(2) 44	n/a	(2) 35	60 x 72	BYZO260072HAD - G ME	1,970	2,230
	(2) 44	n/a	(2) 47	60 x 84	BYZO260084HAD - G ME	1,990	2,270
(2) 44	n/a	(2) 58	60 x 96	BYZO260096HAD - G ME	2,090	2,350	

Standard metal powder coat finishes (ME)

Flat Black, Furniture White, Inner Tone, Light Tone, Medium Tone and Metallic Silver





\* Zoey Conference can be used on other top shapes, email service@symphonytables.com for pricing.



# bases

## Borne & Bati post

### Canty frame

base	max top support	base description	mount plate	qty	model no.	list
<b>Borne base sets (4)</b>						
	48 x 48, 60 rd	2" dia column x 27.75"H, adj glides	4 x 4	4	BPBOR4S02RSDGME	620
	48 x 48	2" dia column cust higher ht, adj glides	4 x 4	4	BPBOR4S02RSHGME	950
	48 x 48, 60 rd	2" dia column cust shorter ht, adj glides	4 x 4	4	BPBOR4S02RSLGME	860
	48 x 48	2" dia column x 27.75"H, 2" black casters	4 x 4	4	BPBOR4S02RSDCME	720
	48 x 48	2" dia column cust higher ht, 2" black casters	4 x 4	4	BPBOR4S02RSHCME	1,050
	48 x 48	2" dia column cust shorter ht, 2" black casters	4 x 4	4	BPBOR4S02RSLCME	950
	48 x 48	2" dia column x 27.75"H, 2" silver/black casters	4 x 4	4	BPBOR4S02RSDPME	760
	48 x 48	2" dia column higher ht, 2" silver/black casters	4 x 4	4	BPBOR4S02RSHPME	1,090
	48 x 48	2" dia column shorter ht, 2" silver/black casters	4 x 4	4	BPBOR4S02RSLPME	1,000
<b>Borne single base (1)</b>						
n/a	2" dia column x 27.75"H, adj glide	4 x 4	1	BPBOR1S02RSDGME	150	
n/a	2" dia column cust higher ht, adj glide	4 x 4	1	BPBOR1S02RSHGME	240	
n/a	2" dia column cust lower ht, adj glide	4 x 4	1	BPBOR1S02RSLGME	210	
	n/a	2" dia column x 27.75"H, 2" black caster	4 x 4	1	BPBOR1S02RSDCME	180
	n/a	2" dia column cust higher ht, 2" black caster	4 x 4	1	BPBOR1S02RSHCME	260
	n/a	2" dia column cust lower ht, 2" black caster	4 x 4	1	BPBOR1S02RSLCME	240
	n/a	2" dia column x 27.75"H, 2" silver/black caster	4 x 4	1	BPBOR1S02RSDPME	190
	n/a	2" dia column cust higher ht, 2" silver/black caster	4 x 4	1	BPBOR1S02RSHPME	280
	n/a	2" dia column cust lower ht, 2" silver/black caster	4 x 4	1	BPBOR1S02RSLPME	250

### Bati single base (1)



*	3" column diameter x 27.75"H	6 x 9	1	BPBAT1S3ODSDBME	500
*	3" column diameter cust higher height	6 x 9	1	BPBAT1S3ODSHBME	630
*	3" column diameter cust shorter height	6 x 9	1	BPBAT1S3ODSLBME	570

\*Bati post legs need to be placed at least every 48". 30" max top depth.

Bati is a surface mounted post base that is bolted to the floor, the base can be centered under the top or offset. The cover for the floor plate is only available in black.

Customer shall supply (4) floor anchors or toggles per base -  
-5/16" anchors required in cement  
-3/8" toggles required in wood

Bati has a 2.5" wire access hole included in the floor plate.

To specify a 1.25" hole in the column use model number **OBPWWHBAT1** - \$50 list per hole

### Canty end base set (2)



20 x 72	18 x 1 x 2 x 27.75"H	1" x 2" x 6" tabs	2	BFCAN20072SDGME	860
24 x 72	22 x 1 x 2 x 27.75"H	1" x 2" x 6" tabs	2	BFCAN24072SDGME	900
30 x 72	28 x 1 x 2 x 27.75"H	1" x 2" x 6" tabs	2	BFCAN30072SDGME	980
36 x 72	34 x 1 x 2 x 27.75"H	1" x 2" x 6" tabs	2	BFCAN36072SDGME	1,020
42 x 72	40 x 1 x 2 x 27.75"H	1" x 2" x 6" tabs	2	BFCAN42072SDGME	1,070
48 x 72	46 x 1 x 2 x 27.75"H	1" x 2" x 6" tabs	2	BFCAN48072SDGME	1,120

\*Custom shorter or taller heights are available for Canty bases with a minimum quantity of 20 bases of the same size email [service@symphonytables.com](mailto:service@symphonytables.com) for more information and pricing. Wire management holes not available for the Canty bases.









#### (ME) Standard metal powder coat finishes :

Black Wrinkle (BW), Chateau Brown Wrinkle (CB), Flat Black (FB),  
Furniture White (FW), Inner Tone (IT), Light Tone (LT), Medium Tone (MT), Metallic  
Silver (MS)

\*Borne and Moto post legs need to be placed every 48"

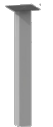
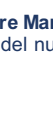
# bases

## Moto post

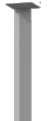
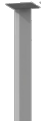
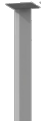
base	max top support	base description	mount plate	qty	model no.	list
<b>Moto base sets (4)</b>						
	2 x 2 inch	48 x 48, 60 rd 2" sq column x 27.75"H, adj glides	6 x 6	4	BPMOT4S02SSDGME	860
		48 x 48, 60 rd 2" sq column cust higher ht, adj glides	6 x 6	4	BPMOT4S02SSHGME	1,290
		48 x 48, 60 rd 2" sq column cust lower ht, adj glides	6 x 6	4	BPMOT4S02SSLGME	1,090
		48 x 48, 60 rd 2" sq column x 27.75"H, 2" black casters	6 x 6	4	BPMOT4S02SSDCME	950
		48 x 48, 60 rd 2" sq column cust higher ht, 2" black casters	6 x 6	4	BPMOT4S02SSHCME	1,380
		48 x 48, 60 rd 2" sq column x cust lower ht, 2" black casters	6 x 6	4	BPMOT4S02SSLCME	1,190
		48 x 48, 60 rd 2" sq column x 27.75"H, 2" silver/black casters	6 x 6	4	BPMOT4S02SSDPME	1,000
		48 x 48, 60 rd 2" sq column cust higher ht, 2" silver/black casters	6 x 6	4	BPMOT4S02SSHPME	1,430
		48 x 48, 60 rd 2" sq column cust lower ht, 2" silver/black casters	6 x 6	4	BPMOT4S02SSLPME	1,230
<b>2.75 x 2.75 inch</b>						
		48 x 48, 60 rd 2.75" sq column x 27.75"H, adj glides	8 x 8	4	BPMOT4S03SSDGME	990
		48 x 48, 60 rd 2.75" sq column cust higher ht, adj glides	8 x 8	4	BPMOT4S03SSHGME	1,520
		48 x 48, 60 rd 2.75" sq column cust lower ht, adj glides	8 x 8	4	BPMOT4S03SSLGME	1,220
		48 x 48, 60 rd 2.75" sq column x 27.75"H, 2" black casters	8 x 8	4	BPMOT4S03SSDCME	1,090
		48 x 48, 60 rd 2.75" sq column cust higher ht, 2" black casters	8 x 8	4	BPMOT4S03SSHCME	1,620
		48 x 48, 60 rd 2.75" sq column cust lower ht, 2" black casters	8 x 8	4	BPMOT4S03SSLCME	1,330
		48 x 48, 60 rd 2.75" sq column x 27.75"H, 2" silver/black casters	8 x 8	4	BPMOT4S03SSDPME	1,140
		48 x 48, 60 rd 2.75" sq column cust higher ht, 2" silver/black casters	8 x 8	4	BPMOT4S03SSHPME	1,660
		48 x 48, 60 rd 2.75" sq column cust lower ht, 2" silver/black casters	8 x 8	4	BPMOT4S03SSLPME	1,380
<b>Moto single base (1)</b>						
	2 x 2 inch	n/a 2" sq column x 27.75"H, adj glide	6 x 6	1	BPMOT1S02SSDGME	210
		n/a 2" sq column cust higher ht, adj glide	6 x 6	1	BPMOT1S02SSHGME	320
		n/a 2" sq column cust lower ht, adj glide	6 x 6	1	BPMOT1S02SSLGME	280
		n/a 2" sq column x 27.75"H, 2" black caster	6 x 6	1	BPMOT1S02SSDCME	240
		n/a 2" sq column cust higher ht, 2" black caster	6 x 6	1	BPMOT1S02SSHCME	340
		n/a 2" sq column cust lower ht, 2" black caster	6 x 6	1	BPMOT1S02SSLCME	300
		n/a 2" sq column x 27.75"H, 2" silver/black caster	6 x 6	1	BPMOT1S02SSDPME	250
		n/a 2" sq column cust higher ht, 2" silver/black caster	6 x 6	1	BPMOT1S02SSHPME	350
		n/a 2" sq column cust lower ht, 2" silver/black caster	6 x 6	1	BPMOT1S02SSLPME	310
<b>2.75 x 2.75 inch</b>						
		n/a 2.75" sq column x 27.75"H, adj glide	8 x 8	1	BPMOT1S03SSDGME	250
		n/a 2.75" sq column cust higher ht, adj glide	8 x 8	1	BPMOT1S03SSHGME	390
		n/a 2.75" sq column cust lower ht, adj glide	8 x 8	1	BPMOT1S03SSLGME	310
		n/a 2.75" sq column x 27.75"H, 2" black casters	8 x 8	1	BPMOT1S03SSDCME	280
		n/a 2.75" sq column cust higher ht, 2" black casters	8 x 8	1	BPMOT1S03SSHCME	410
		n/a 2.75" sq column cust lower ht, 2" black casters	8 x 8	1	BPMOT1S03SSLCME	330
		n/a 2.75" sq column x 27.75"H, 2" silver/black casters	8 x 8	1	BPMOT1S03SSDPME	290
		n/a 2.75" sq column cust higher ht, 2" silver/black casters	8 x 8	1	BPMOT1S03SSHPME	420
		n/a 2.75" sq column cust lower ht, 2" silver / black casters	8 x 8	1	BPMOT1S03SSLPME	340

#### Corner mount plate option (Borne & Moto post bases):

Model number **OBPPCM4V** for a set of 4 post bases - \$180 list per set

Model number **OBPPCM1V** for (1) post base - \$40 list per base

#### Wire Management hole option (Borne & Moto post bases):

Model number **OBPWWHBOR** for 1.5" dia. wire management holes at the top and bottom of a Borne post base - \$60 list per base



bases  
frame  
Moto (glides)

base	outside base dimensions	top size with 1" overhang on each side	base height	model no.	list	glides	finish
Moto Frame Seated Height (27.75"H)	22 x 22	24 x 24	27.75	BFMOT24024SDGME	1,400	adj glides	standard metal
	22 x 34	24 x 36	27.75	BFMOT24036SDGME	1,430	adj glides	standard metal
	22 x 40	24 x 42	27.75	BFMOT24042SDGME	1,440	adj glides	standard metal
	22 x 46	24 x 48	27.75	BFMOT24048SDGME	1,490	adj glides	standard metal
	22 x 58	24 x 60	27.75	BFMOT24060SDGME	1,500	adj glides	standard metal
	22 x 70	24 x 72	27.75	BFMOT24072SDGME	1,540	adj glides	standard metal
	28 x 28	30 x 30	27.75	BFMOT30030SDGME	1,430	adj glides	standard metal
	28 x 34	30 x 36	27.75	BFMOT30036SDGME	1,440	adj glides	standard metal
	28 x 40	30 x 42	27.75	BFMOT30042SDGME	1,450	adj glides	standard metal
	28 x 46	30 x 48	27.75	BFMOT30048SDGME	1,460	adj glides	standard metal
	28 x 58	30 x 60	27.75	BFMOT30060SDGME	1,520	adj glides	standard metal
	28 x 70	30 x 72	27.75	BFMOT30072SDGME	1,550	adj glides	standard metal
	34 x 34	36 x 36	27.75	BFMOT36036SDGME	1,490	adj glides	standard metal
	34 x 40	36 x 42	27.75	BFMOT36042SDGME	1,500	adj glides	standard metal
	34 x 46	36 x 48	27.75	BFMOT36048SDGME	1,510	adj glides	standard metal
34 x 58	36 x 60	27.75	BFMOT36060SDGME	1,570	adj glides	standard metal	
34 x 70	36 x 72	27.75	BFMOT36072SDGME	1,610	adj glides	standard metal	
40 x 40	42 x 42	27.75	BFMOT42042SDGME	1,510	adj glides	standard metal	
40 x 46	42 x 48	27.75	BFMOT42048SDGME	1,520	adj glides	standard metal	
40 x 58	42 x 60	27.75	BFMOT42060SDGME	1,550	adj glides	standard metal	
40 x 70	42 x 72	27.75	BFMOT42072SDGME	1,580	adj glides	standard metal	
46 x 46	48 x 48	27.75	BFMOT48048SDGME	1,530	adj glides	standard metal	
46 x 58	48 x 60	27.75	BFMOT48060SDGME	1,600	adj glides	standard metal	
46 x 70	48 x 72	27.75	BFMOT48060SDGME	1,630	adj glides	standard metal	
Moto Frame Counter Height (34.75"H)	22 x 22	24 x 24	34.75	BFMOT24024SCGME	1,500	adj glides	standard metal
	22 x 34	24 x 36	34.75	BFMOT24036SCGME	1,520	adj glides	standard metal
	22 x 40	24 x 42	34.75	BFMOT24042SCGME	1,530	adj glides	standard metal
	22 x 46	24 x 48	34.75	BFMOT24048SCGME	1,600	adj glides	standard metal
	22 x 58	24 x 60	34.75	BFMOT24060SCGME	1,610	adj glides	standard metal
	22 x 70	24 x 72	34.75	BFMOT24072SCGME	1,640	adj glides	standard metal
	28 x 28	30 x 30	34.75	BFMOT30030SCGME	1,520	adj glides	standard metal
	28 x 34	30 x 36	34.75	BFMOT30036SCGME	1,530	adj glides	standard metal
	28 x 40	30 x 42	34.75	BFMOT30042SCGME	1,540	adj glides	standard metal
	28 x 46	30 x 48	34.75	BFMOT30048SCGME	1,550	adj glides	standard metal
	28 x 58	30 x 60	34.75	BFMOT30060SCGME	1,620	adj glides	standard metal
	28 x 70	30 x 72	34.75	BFMOT30072SCGME	1,650	adj glides	standard metal
	34 x 34	36 x 36	34.75	BFMOT36036SCGME	1,580	adj glides	standard metal
	34 x 40	36 x 42	34.75	BFMOT36042SCGME	1,600	adj glides	standard metal
	34 x 46	36 x 48	34.75	BFMOT36048SCGME	1,610	adj glides	standard metal
	34 x 58	36 x 60	34.75	BFMOT36060SCGME	1,660	adj glides	standard metal
	34 x 70	36 x 72	34.75	BFMOT36072SCGME	1,690	adj glides	standard metal
	40 x 40	42 x 42	34.75	BFMOT42042SCGME	1,610	adj glides	standard metal
	40 x 46	42 x 48	34.75	BFMOT42048SCGME	1,620	adj glides	standard metal
	40 x 58	42 x 60	34.75	BFMOT42060SCGME	1,650	adj glides	standard metal
	40 x 70	42 x 72	34.75	BFMOT42072SCGME	1,670	adj glides	standard metal
46 x 46	48 x 48	34.75	BFMOT48048SCGME	1,630	adj glides	standard metal	
46 x 58	48 x 60	34.75	BFMOT48060SCGME	1,680	adj glides	standard metal	
46 x 70	48 x 72	34.75	BFMOT48060SCGME	1,730	adj glides	standard metal	

bases  
frame  
Moto (glides)

base	outside base dimensions	top size with 1" overhang on each side	base height	model no.	list	glides	finish
Moto Frame Bar Height (40.75"H)	22 x 22	24 x 24	40.75	BFMOT24024SBGME	1,580	adj glides	standard metal
	22 x 34	24 x 36	40.75	BFMOT24036SBGME	1,610	adj glides	standard metal
	22 x 40	24 x 42	40.75	BFMOT24042SBGME	1,630	adj glides	standard metal
	22 x 46	24 x 48	40.75	BFMOT24048SBGME	1,670	adj glides	standard metal
	22 x 58	24 x 60	40.75	BFMOT24060SBGME	1,690	adj glides	standard metal
	22 x 70	24 x 72	40.75	BFMOT24072SBGME	1,730	adj glides	standard metal
	28 x 28	30 x 30	40.75	BFMOT30030SBGME	1,610	adj glides	standard metal
	28 x 34	30 x 36	40.75	BFMOT30036SBGME	1,620	adj glides	standard metal
	28 x 40	30 x 42	40.75	BFMOT30042SBGME	1,630	adj glides	standard metal
	28 x 46	30 x 48	40.75	BFMOT30048SBGME	1,640	adj glides	standard metal
	28 x 58	30 x 60	40.75	BFMOT30060SBGME	1,690	adj glides	standard metal
	28 x 70	30 x 72	40.75	BFMOT30072SBGME	1,740	adj glides	standard metal
	34 x 34	36 x 36	40.75	BFMOT36036SBGME	1,660	adj glides	standard metal
	34 x 40	36 x 42	40.75	BFMOT36042SBGME	1,670	adj glides	standard metal
	34 x 46	36 x 48	40.75	BFMOT36048SBGME	1,680	adj glides	standard metal
34 x 58	36 x 60	40.75	BFMOT36060SBGME	1,750	adj glides	standard metal	
34 x 70	36 x 72	40.75	BFMOT36072SBGME	1,780	adj glides	standard metal	
40 x 40	42 x 42	40.75	BFMOT42042SBGME	1,680	adj glides	standard metal	
40 x 46	42 x 48	40.75	BFMOT42048SBGME	1,690	adj glides	standard metal	
40 x 58	42 x 60	40.75	BFMOT42060SBGME	1,740	adj glides	standard metal	
40 x 70	42 x 72	40.75	BFMOT42072SBGME	1,760	adj glides	standard metal	
46 x 46	48 x 48	40.75	BFMOT48048SBGME	1,720	adj glides	standard metal	
46 x 58	48 x 60	40.75	BFMOT48060SBGME	1,770	adj glides	standard metal	
46 x 70	48 x 72	40.75	BFMOT48060SBGME	1,800	adj glides	standard metal	

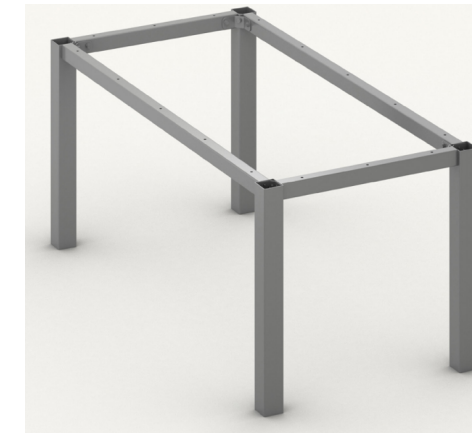

(ME) Standard metal powder coat finishes :  
Black Wrinkle (BW), Chateau Brown Wrinkle (CB), Flat Black (FB),  
Furniture White (FW), Inner Tone (IT), Light Tone (LT), Medium Tone (MT), Metallic Silver

Wire Management hole option:  
Model number **OBWMHMOTO** for 1.5" dia. wire management holes at the top and bottom of a Moto base - \$60 list per base

bases  
frame  
Moto (casters)

base	outside base dimensions	top size with 1" overhang on each side	base height	model no.	list	casters	finish
Moto Frame Seated Height (27.75"H)	22 x 22	24 x 24	27.75	BFMOT24024SDCME	1,640	3.5"H locking	standard metal
	22 x 34	24 x 36	27.75	BFMOT24036SDCME	1,670	3.5"H locking	standard metal
	22 x 40	24 x 42	27.75	BFMOT24042SDCME	1,680	3.5"H locking	standard metal
	22 x 46	24 x 48	27.75	BFMOT24048SDCME	1,730	3.5"H locking	standard metal
	22 x 58	24 x 60	27.75	BFMOT24060SDCME	1,740	3.5"H locking	standard metal
	22 x 70	24 x 72	27.75	BFMOT24072SDCME	1,780	3.5"H locking	standard metal
	28 x 28	30 x 30	27.75	BFMOT30030SDCME	1,670	3.5"H locking	standard metal
	28 x 34	30 x 36	27.75	BFMOT30036SDCME	1,680	3.5"H locking	standard metal
	28 x 40	30 x 42	27.75	BFMOT30042SDCME	1,690	3.5"H locking	standard metal
	28 x 46	30 x 48	27.75	BFMOT30048SDCME	1,710	3.5"H locking	standard metal
	28 x 58	30 x 60	27.75	BFMOT30060SDCME	1,760	3.5"H locking	standard metal
	28 x 70	30 x 72	27.75	BFMOT30072SDCME	1,790	3.5"H locking	standard metal
	34 x 34	36 x 36	27.75	BFMOT36036SDCME	1,730	3.5"H locking	standard metal
	34 x 40	36 x 42	27.75	BFMOT36042SDCME	1,740	3.5"H locking	standard metal
	34 x 46	36 x 48	27.75	BFMOT36048SDCME	1,750	3.5"H locking	standard metal
	34 x 58	36 x 60	27.75	BFMOT36060SDCME	1,820	3.5"H locking	standard metal
	34 x 70	36 x 72	27.75	BFMOT36072SDCME	1,850	3.5"H locking	standard metal
	40 x 40	42 x 42	27.75	BFMOT42042SDCME	1,750	3.5"H locking	standard metal
	40 x 46	42 x 48	27.75	BFMOT42048SDCME	1,760	3.5"H locking	standard metal
	40 x 58	42 x 60	27.75	BFMOT42060SDCME	1,790	3.5"H locking	standard metal
40 x 70	42 x 72	27.75	BFMOT42072SDCME	1,830	3.5"H locking	standard metal	
46 x 46	48 x 48	27.75	BFMOT48048SDCME	1,770	3.5"H locking	standard metal	
46 x 58	48 x 60	27.75	BFMOT48060SDCME	1,840	3.5"H locking	standard metal	
46 x 70	48 x 72	27.75	BFMOT48060SDCME	1,870	3.5"H locking	standard metal	
Moto Frame Counter Height (34.75"H)	22 x 22	24 x 24	34.75	BFMOT24024SCCME	1,740	3.5"H locking	standard metal
	22 x 34	24 x 36	34.75	BFMOT24036SCCME	1,760	3.5"H locking	standard metal
	22 x 40	24 x 42	34.75	BFMOT24042SCCME	1,770	3.5"H locking	standard metal
	22 x 46	24 x 48	34.75	BFMOT24048SCCME	1,840	3.5"H locking	standard metal
	22 x 58	24 x 60	34.75	BFMOT24060SCCME	1,850	3.5"H locking	standard metal
	22 x 70	24 x 72	34.75	BFMOT24072SCCME	1,880	3.5"H locking	standard metal
	28 x 28	30 x 30	34.75	BFMOT30030SCCME	1,760	3.5"H locking	standard metal
	28 x 34	30 x 36	34.75	BFMOT30036SCCME	1,770	3.5"H locking	standard metal
	28 x 40	30 x 42	34.75	BFMOT30042SCCME	1,780	3.5"H locking	standard metal
	28 x 46	30 x 48	34.75	BFMOT30048SCCME	1,790	3.5"H locking	standard metal
	28 x 58	30 x 60	34.75	BFMOT30060SCCME	1,860	3.5"H locking	standard metal
	28 x 70	30 x 72	34.75	BFMOT30072SCCME	1,890	3.5"H locking	standard metal
	34 x 34	36 x 36	34.75	BFMOT36036SCCME	1,830	3.5"H locking	standard metal
	34 x 40	36 x 42	34.75	BFMOT36042SCCME	1,840	3.5"H locking	standard metal
	34 x 46	36 x 48	34.75	BFMOT36048SCCME	1,850	3.5"H locking	standard metal
	34 x 58	36 x 60	34.75	BFMOT36060SCCME	1,900	3.5"H locking	standard metal
	34 x 70	36 x 72	34.75	BFMOT36072SCCME	1,940	3.5"H locking	standard metal
	40 x 40	42 x 42	34.75	BFMOT42042SCCME	1,850	3.5"H locking	standard metal
	40 x 46	42 x 48	34.75	BFMOT42048SCCME	1,860	3.5"H locking	standard metal
	40 x 58	42 x 60	34.75	BFMOT42060SCCME	1,890	3.5"H locking	standard metal
40 x 70	42 x 72	34.75	BFMOT42072SCCME	1,910	3.5"H locking	standard metal	
46 x 46	48 x 48	34.75	BFMOT48048SCCME	1,870	3.5"H locking	standard metal	
46 x 58	48 x 60	34.75	BFMOT48060SCCME	1,930	3.5"H locking	standard metal	
46 x 70	48 x 72	34.75	BFMOT48060SCCME	1,970	3.5"H locking	standard metal	

bases  
frame  
Moto (casters)

base	outside base dimensions	top size with 1" overhang on each side	base height	model no.	list	casters	finish
Moto Frame Bar Height (40.75"H)	22 x 22	24 x 24	40.75	BFMOT24024SBCME	1,830	3.5"H locking	standard metal
	22 x 34	24 x 36	40.75	BFMOT24036SBCME	1,850	3.5"H locking	standard metal
	22 x 40	24 x 42	40.75	BFMOT24042SBCME	1,870	3.5"H locking	standard metal
	22 x 46	24 x 48	40.75	BFMOT24048SBCME	1,910	3.5"H locking	standard metal
	22 x 58	24 x 60	40.75	BFMOT24060SBCME	1,940	3.5"H locking	standard metal
	22 x 70	24 x 72	40.75	BFMOT24072SBCME	1,970	3.5"H locking	standard metal
	28 x 28	30 x 30	40.75	BFMOT30030SBCME	1,850	3.5"H locking	standard metal
	28 x 34	30 x 36	40.75	BFMOT30036SBCME	1,860	3.5"H locking	standard metal
	28 x 40	30 x 42	40.75	BFMOT30042SBCME	1,870	3.5"H locking	standard metal
	28 x 46	30 x 48	40.75	BFMOT30048SBCME	1,880	3.5"H locking	standard metal
	28 x 58	30 x 60	40.75	BFMOT30060SBCME	1,940	3.5"H locking	standard metal
	28 x 70	30 x 72	40.75	BFMOT30072SBCME	1,980	3.5"H locking	standard metal
	34 x 34	36 x 36	40.75	BFMOT36036SBCME	1,900	3.5"H locking	standard metal
	34 x 40	36 x 42	40.75	BFMOT36042SBCME	1,910	3.5"H locking	standard metal
	34 x 46	36 x 48	40.75	BFMOT36048SBCME	1,930	3.5"H locking	standard metal
	34 x 58	36 x 60	40.75	BFMOT36060SBCME	1,990	3.5"H locking	standard metal
	34 x 70	36 x 72	40.75	BFMOT36072SBCME	2,020	3.5"H locking	standard metal
	40 x 40	42 x 42	40.75	BFMOT42042SBCME	1,930	3.5"H locking	standard metal
	40 x 46	42 x 48	40.75	BFMOT42048SBCME	1,940	3.5"H locking	standard metal
	40 x 58	42 x 60	40.75	BFMOT42060SBCME	1,980	3.5"H locking	standard metal
40 x 70	42 x 72	40.75	BFMOT42072SBCME	2,000	3.5"H locking	standard metal	
46 x 46	48 x 48	40.75	BFMOT48048SBCME	1,960	3.5"H locking	standard metal	
46 x 58	48 x 60	40.75	BFMOT48060SBCME	2,010	3.5"H locking	standard metal	
46 x 70	48 x 72	40.75	BFMOT48060SBCME	2,050	3.5"H locking	standard metal	



\*top not included

**(ME) Standard metal powder coat finishes :**

Black Wrinkle (BW), Chateau Brown Wrinkle (CB), Flat Black (FB), Furniture White (FW), Inner Tone (IT), Light Tone (LT), Medium Tone (MT), Metallic Silver

**Wire Management hole option:**

Model number **OBWMMOTO** for 1.5" dia. wire management holes at the top and bottom of a Moto base - **\$60 list per base**

# bases

## post

### Krauss

# bases

## post

### Krauss

base	angle	base description	mount plate	Qty	model no.	list for (1) post base
Krauss	22 degrees	2" x 2" x 16.75"H angled column	6 x 6	1	BPKRA12022SOGME	260
	22 degrees	2" x 2" x 27.75"H angled column	6 x 6	1	BPKRA12022SDGME	260
	22 degrees	2.75" x 2.75" x 16.75"H angled column	8 x 8	1	BPKRA13022SOGME	290
	22 degrees	2.75" x 2.75" x 27.75"H angled column	8 x 8	1	BPKRA13022SDGME	290
	30 degrees	2.75" x 2.75" x 27.75"H angled column*	8 x 8	1	BPKRA13030SDGME	290

\*2.75" 30 degree angle base shall be used with 42" or 48" deep rectangle tops

**(ME) Standard metal powder coat finishes :**

Black Wrinkle (BW), Chateau Brown Wrinkle (CB), Flat Black (FB), Furniture White (FW), Inner Tone (IT), Light Tone (LT), Medium Tone (MT), Metallic Silver (MS).

\* The above pricing for the **Krauss series angled post base** is for a single base. Due to the versatility of this base, please email [service@symphonytables.com](mailto:service@symphonytables.com) to verify how many bases you will need and quantity of bases required to support your top.

Note that the height of the base as well as the degree angle of the base will determine the top size that it will support. We encourage you to contact our support team to obtain a drawing to verify that the bases will fit under the intended top size.

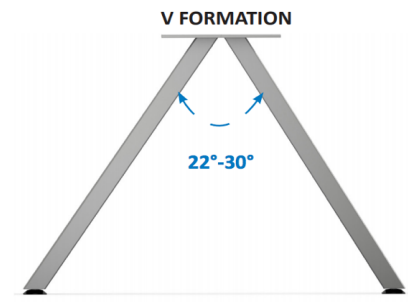
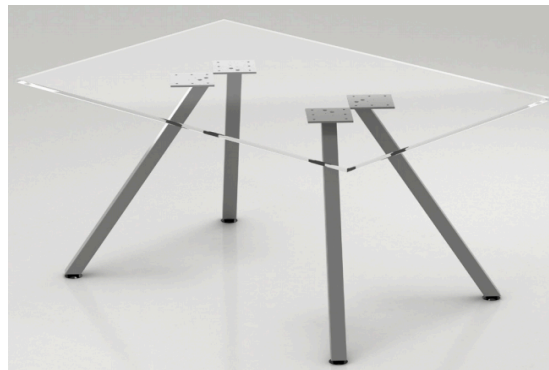

Picture above shows two column legs in V Formation. Multiple variations can be used with this column. Pricing is done per column.

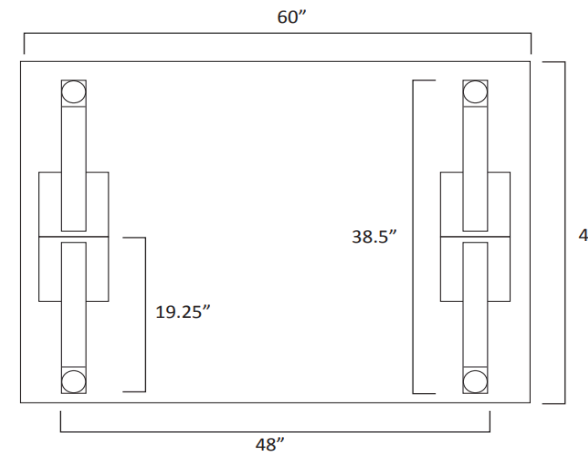

Suggested Max Top size of 42" x 60"

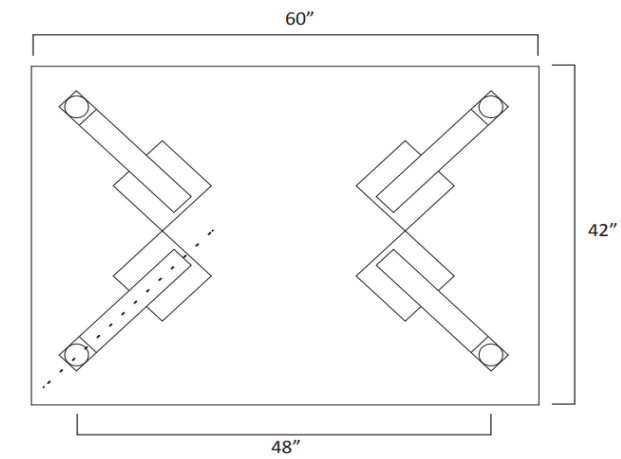

Suggested Max Top size of 42" x 60"

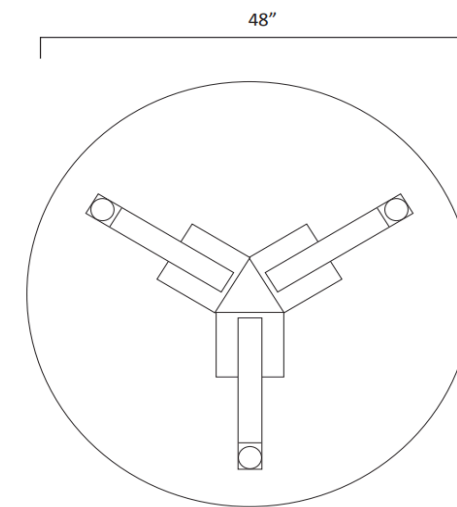

Suggested Max Top size of 48" dia.

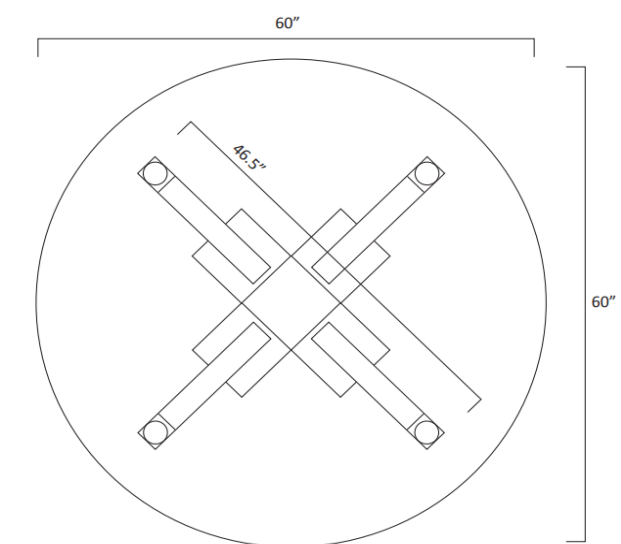

Suggested Max Top size of 60" dia.



rectangle table with (4) Krauss 2.00 x 2.00 legs



rectangle table with (4) Krauss 2.75 x 2.75 legs



# bases

## post

### Pyra

base	base description	base height	qty	model no.	list
Pyra	tapered angled post base with wire management in base, adj glides	27.75	4	BPPYR4STASDGME	840
	tapered angled post base with wire management in base, adj glides	34.75	4	BPPYR4STASCGME	940
	tapered angled post base with wire management in base, adj glides	40.75	4	BPPYR4STASBGME	1,000



reference illustrations to view the minimum and maximum top sizes for each base overall base height (27.75"H, 34.75"H, 40.75"H bases)  
**weight capacity is 200 lbs including the top for a set of 4 bases**

(ME) Standard metal powder coat finishes :  
 Flat Black (FB), Furniture White (FW), Inner Tone (IT), Light Tone (LT), Medium Tone

Note that the maximum table top diameter that 4 bases will hold is 60" round

ILLUSTRATION A

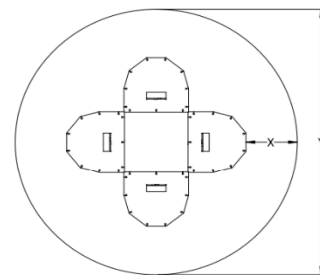

**ROUND TOP CENTER CONFIGURATION**

**42" H legs** X: 8.75" Y: 48" (minimum table top size)  
**36" H legs** X: 6.8125" Y: 46" (minimum table top size)  
**29" H legs** X: 4.75" Y: 40" (minimum table top size)

ILLUSTRATION B

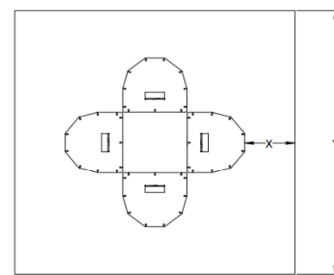

**SQUARE TOP CENTER CONFIGURATION**

**42"** X: 8.75" Y: 48" (minimum table top size)  
**36"** X: 6.8125" Y: 46" (minimum table top size)  
**29"** X: 4.75" Y: 40" (minimum table top size)



ILLUSTRATION C

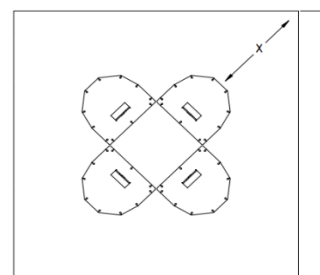

**SQUARE TOP CORNER CONFIGURATION**

**42" H legs** X: 11.5" Y: 38" (minimum table top size)  
**36" H legs** X: 9.5" Y: 36" (minimum table top size)  
**29" H legs** X: 7.375" Y: 32" (minimum table top size)

Maximum tabletop diameter is 60".

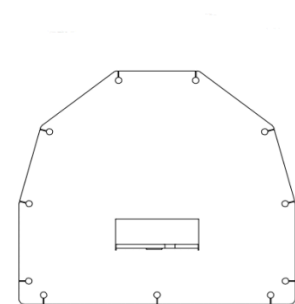

**MOUNTING PLATE**



power/data  
 + wire management

\* top size range: 42 x 42 up to 60 x 60

# power supply location chart

## long ways on top

Our main focus is integrating technology into tables for learning and meeting environments. We invite you to email [service@symphonytables.com](mailto:service@symphonytables.com) for help with specifying your project. For the additional resources, please visit [www.symphonytables.com](http://www.symphonytables.com).

Please specify the power supply location cut out on your PO:

POWER MODULE LOCATIONS FOR UNITS RUNNING LONG WAYS ON THE TOP:

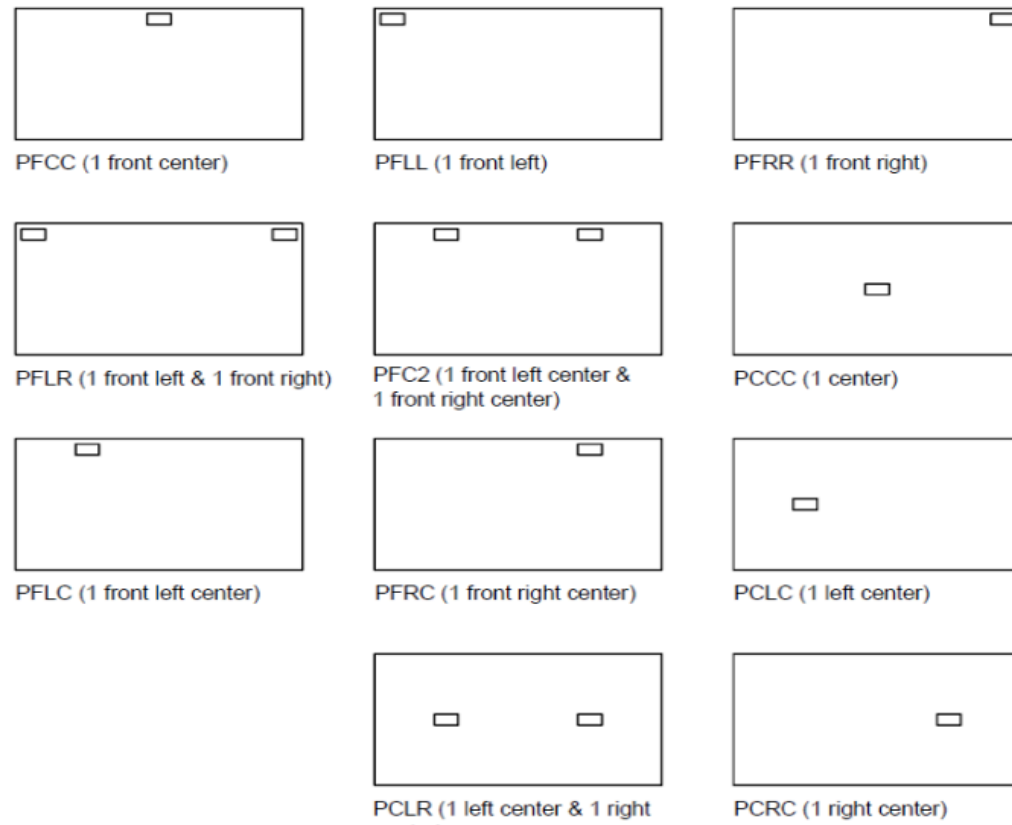

Note that power supplies cannot be placed over metal base plates, contact [service@symphonytables.com](mailto:service@symphonytables.com) to ensure that the power supply location will work with your base placement and all of the other options / accessories specified on the table.

# power supply location chart

## short ways on top

Please specify the power supply location cut out on your PO:



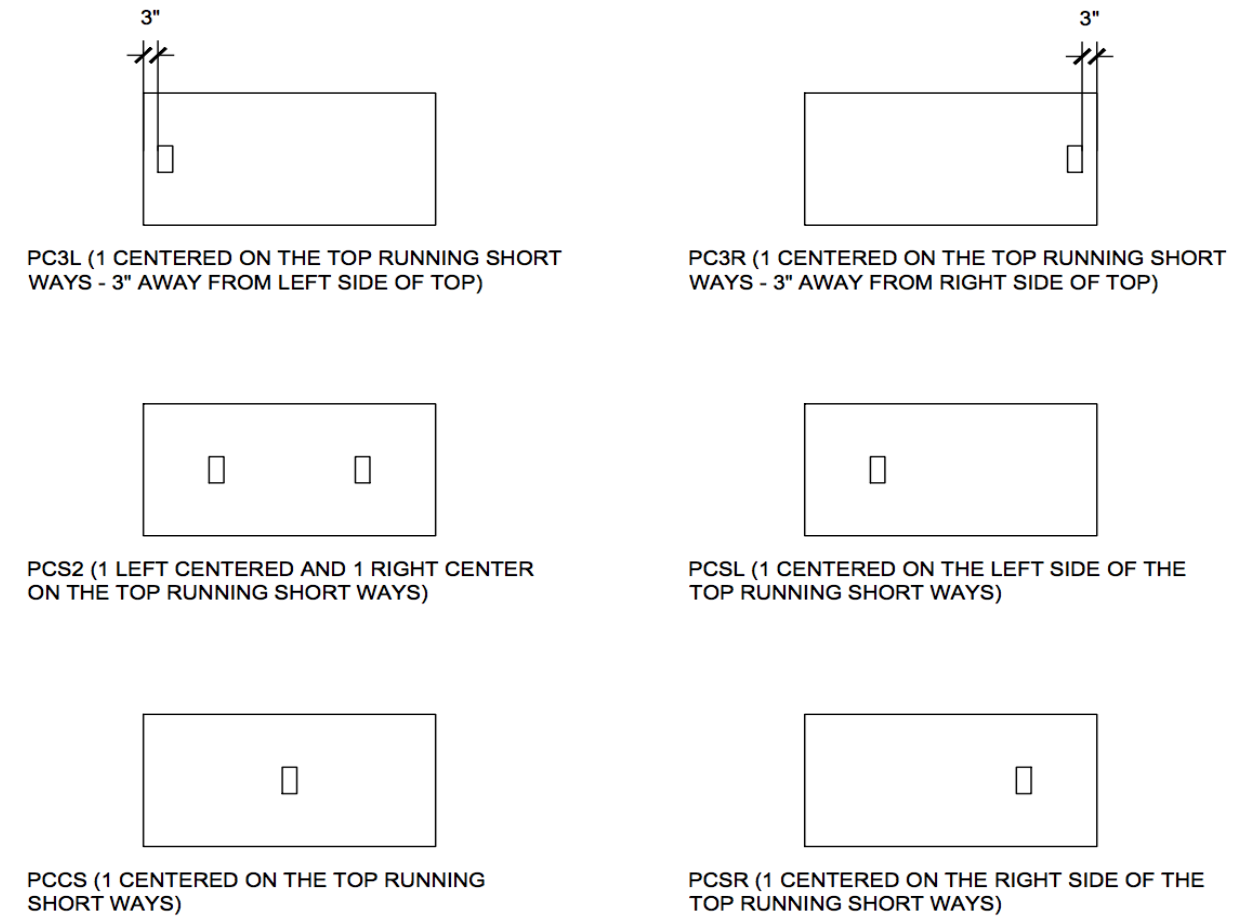







POWER MODULE LOCATIONS FOR UNITS RUNNING SHORT WAYS ON THE TOP:



Note that power supplies cannot be placed over metal base plates, contact [service@symphonytables.com](mailto:service@symphonytables.com) to ensure that the power supply location will work with your base placement and all of the other options / accessories specified on the table.

# power/data modules

Ariba in surface

module	description	# of ports	model no.	cord length	finish code	list
<b>Ariba in surface single-sided unit</b>						
	2 power 3"D x 4.5"W table top cut out, specify location cut out shall have 1/4" radius corners	2	OPPARI2P0A0D06GW	6 ft.	GW	330
			OPPARI2P0A0D06GB	6 ft.	GB	330
			OPPARI2P0A0D06GS	6 ft.	GS	330
	1 power, 1 dual charging USB-A 3"D x 4.5"W table top cut out, specify location cut out shall have 1/4" radius corners	2	OPPARI1P1A0D06GW	6 ft.	GW	440
			OPPARI1P1A0D06GB	6 ft.	GB	440
			OPPARI1P1A0D06GS	6 ft.	GS	440
	1 power, 1 USB-A+C 3"D x 4.5"W table top cut out, specify location cut out shall have 1/4" radius corners	2	OPPARI1PAC0D06GW	6 ft.	GW	530
			OPPARI1PAC0D06GB	6 ft.	GB	530
			OPPARI1PAC0D06GS	6 ft.	GS	530
	2 power, 1 dual charging USB-A, 1 USB A+C 3"D x 6-15/16"W table top cut out, specify location cut out shall have 3/8" radius corners	4	OPPARI2P1AAC06GW	6 ft.	GW	590
			OPPARI2P1AAC06GB	6 ft.	GB	590
			OPPARI2P1AAC06GS	6 ft.	GS	590
	3 power, 1 open data 3"D x 6-15/16"W table top cut out, specify location cut out shall have 3/8" radius corners	4	OPPARI3P0A1D06GW	6 ft.	GW	410
			OPPARI3P0A1D06GB	6 ft.	GB	410
			OPPARI3P0A1D06GS	6 ft.	GS	410
	3 power, 1 USB-A 3"D x 6-15/16"W table top cut out, specify location cut out shall have 3/8" radius corners	4	OPPARI3P1A0D06GW	6 ft.	GW	530
			OPPARI3P1A0D06GB	6 ft.	GB	530
			OPPARI3P1A0D06GS	6 ft.	GS	530
	3 power, 1 USB-A+C 3"D x 6-15/16"W table top cut out, specify location cut out shall have 3/8" radius corners	4	OPPARI3PAC0D06GW	6 ft.	GW	550
			OPPARI3PAC0D06GB	6 ft.	GB	550
			OPPARI3PAC0D06GS	6 ft.	GS	550
	2 power, 1 HDMI, 1 USB-A+C 3"D x 6-15/16"W table top cut out, specify location cut out shall have 3/8" radius corners	4	OPPARI2P1HAC06GW	6 ft.	GW	550
			OPPARI2P1HAC06GB	6 ft.	GB	550
			OPPARI2P1HAC06GS	6 ft.	GS	550
	2 power, 1 USB-A, 1 open data 3"D x 6-15/16"W table top cut out, specify location cut out shall have 3/8" radius corners	4	OPPARI2P1A1D06GW	6 ft.	GW	500
			OPPARI2P1A1D06GB	6 ft.	GB	500
			OPPARI2P1A1D06GS	6 ft.	GS	500
	2 power, 2 USB-A 3"D x 6-15/16"W table top cut out, specify location cut out shall have 3/8" radius corners	4	OPPARI2P2A0D06GW	6 ft.	GW	620
			OPPARI2P2A0D06GB	6 ft.	GB	620
			OPPARI2P2A0D06GS	6 ft.	GS	620
			OPPARI2P2A0D10GW	10 ft.	GW	640
			OPPARI2P2A0D10GB	10 ft.	GB	640
			OPPARI2P2A0D10GS	10 ft.	GS	640

Ariba 2 port in surface cut out information:

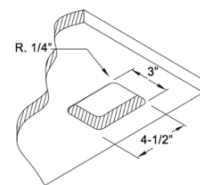

Ariba 4 port in surface cut out information:

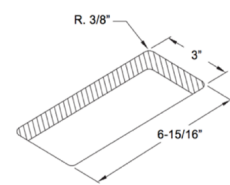









**ARIBA SERIES FINISH CODE LEGEND:**

-  **GW** - Gloss white finish, white cord
-  **GB** - Gloss black finish, black cord
-  **GS** - Gloss storm finish, black cord

# power/data modules

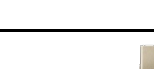
Asti and Asti II in surface

Asti undermount

module	description	model no.	grommet finish	module finish	list
<b>Asti in surface</b>					
	2 power, 1 convenience outlet below the worksurface, 108 inch cord	OPPAST2P0UDR91SB	silver	silver	470
		OPPAST2P0UDR91BB	black	black	470
		OPPAST2P0UDR91WW	white	silver	470
	2 open data ports for RJ45 Cat 6 data (data jacks not included) 3"D x 5.25"W table top cut out size - specify placement	OPPAST2P0UDR91AB	brushed	black	560
		OPPAST2P0UDR91ST	stainless steel	black	560
		OPPAST2P1UDR91SB	silver	silver	670
	2 power, 1 dual charging USB-A, 1 convenience outlet below the worksurface, 108 inch cord	OPPAST2P1UDR91BB	black	black	670
		OPPAST2P1UDR91WW	white	silver	670
		OPPAST2P1UDR91AB	brushed	black	760
	3"D x 5.25"W table top cut out size - specify placement	OPPAST2P1UDR91ST	stainless steel	black	760
		OPPAS22P0UDR93SB	silver	silver	560
		OPPAS22P0UDR93BB	black	black	560
	2 power at the surface, 3 convenience outlets below the worksur face, 108 inch cord	OPPAS22P0UDR93WW	white	white	560
		OPPAS22P0UDR93AB	brushed	black	650
		OPPAS22P0UDR93ST	stainless steel	black	650
	2 power at the surface, 1 dual charging USB-A 3 convenience outlets below the worksurface, 108 inch cord	OPPAS22P1UDR93SB	silver	silver	770
		OPPAS22P1UDR93BB	black	black	770
		OPPAS22P1UDR93WW	white	white	770
	1 open data port for an RJ45 Cat 6 data (data jack not included) 3"D x 5.25"W table top cut out size - specify placement	OPPAS22P1UDR93AB	brushed	black	860
		OPPAS22P1UDR93ST	stainless steel	black	860
		OPPASU3P0U0D9BB	n/a	silver	330
	2 power, 1 convenience outlet under surface mount power unit, 108" cord, no cut out required	OPPASU3P0U0D9SB	n/a	black	330

Asti undermount







\*\* You can daisy chain up to (4) Asti units with a 20 amp single circuit outlet

\*\*\* Ariba and Asti modules have many different configurations available within the family offering, including hardwired solutions, email [service@symphonytables.com](mailto:service@symphonytables.com) for assistance if you are looking for additional power/data/USB features for your project.





# power/data modules

Aya  
in surface

module	description	# of ports	model no.	cord length	finish code	list				
	2 power, 1 dual charging USB-A 2"D x 5.25"W table top cut out, specify location	3	OPPAYA2P1A0D06MS	6 ft.	MS	490				
			OPPAYA2P1A0D06MW	6 ft.	MW	490				
			OPPAYA2P1A0D06MB	6 ft.	MB	490				
			2 power, 1 USB A+C 2"D x 5.25"W table top cut out, specify location	3	OPPAYA2PAC0D06MS	6 ft.	MS	490		
					OPPAYA2PAC0D06MW	6 ft.	MW	490		
					OPPAYA2PAC0D06MB	6 ft.	MB	490		
					2 power, 1 dual charging USB-A, 1 open data 2"D x 6.75"W table top cut out, specify location	4	OPPAYA2P1A1D06MS	6 ft.	MS	510
							OPPAYA2P1A1D06MW	6 ft.	MW	510
							OPPAYA2P1A1D06MB	6 ft.	MB	510
	2 power, 1 dual charging USB-A, 1 USB-A+C 2"D x 6.75"W table top cut out, specify location	4	OPPAYA2P1AAC06MS	6 ft.	MS	620				
			OPPAYA2P1AAC06MW	6 ft.	MW	620				
			OPPAYA2P1AAC06MB	6 ft.	MB	620				
			2 power, 1 USB-A+C, 1 HDMI 2"D x 6.75"W table top cut out, specify location	4	OPPAYA2PAC1H06MS	6 ft.	MS	570		
					OPPAYA2PAC1H06MW	6 ft.	MW	570		
					OPPAYA2PAC1H06MB	6 ft.	MB	570		
	2 power, 1 USB-A+C, 1 dual USB-C 45w 2"D x 6.75"W table top cut out, specify location	4	OPPAYA2PAC1C06MS	6 ft.	MS	730				
			OPPAYA2PAC1C06MW	6 ft.	MW	730				
			OPPAYA2PAC1C06MB	6 ft.	MB	730				
			3 power, 1 open data 2"D x 6.75"W table top cut out, specify location	4	OPPAYA3P0A1D06MS	6 ft.	MS	380		
					OPPAYA3P0A1D06MW	6 ft.	MW	380		
					OPPAYA3P0A1D06MB	6 ft.	MB	380		
	3 power, 1 USB-A+C, 2 open data 2"D x 9.75"W table top cut out, specify location	6	OPPAYA3PAC2D06MS	6 ft.	MS	590				
			OPPAYA3PAC2D06MW	6 ft.	MW	590				
			OPPAYA3PAC2D06MB	6 ft.	MB	590				
			3 power, 1 USB-A+C, 2 open data 2"D x 9.75"W table top cut out, specify location	6	OPPAYA3PAC2D10MS	10 ft.	MS	610		
					OPPAYA3PAC2D10MW	10 ft.	MW	610		
					OPPAYA3PAC2D10MB	10 ft.	MB	610		

# power/data modules

Aya  
freestanding and clamp mount



module	description	# of ports	model no.	cord length	finish code	list	
	1 power, 1 USB-A+C, 1 dual USB-C 45w	3	OPPAYF1PAC1C06MS	6 ft.	MS	700	
			OPPAYF1PAC1C06MW	6 ft.	MW	700	
			OPPAYF1PAC1C06MB	6 ft.	MB	700	
			OPPAYF1PAC1C10MS	10 ft.	MS	720	
			OPPAYF1PAC1C10MW	10 ft.	MW	720	
			OPPAYF1PAC1C10MB	10 ft.	MB	720	
		2 power, 1 USB-A+C, 1 dual USB-A	4	OPPAYF1PAC1A06MS	6 ft.	MS	620
				OPPAYF1PAC1A06MW	6 ft.	MW	620
				OPPAYF1PAC1A06MB	6 ft.	MB	620
				OPPAYF1PAC1A10MS	10 ft.	MS	640
				OPPAYF1PAC1A10MW	10 ft.	MW	640
				OPPAYF1PAC1A10MB	10 ft.	MB	640
	1 power, 1 USB-A+C, 1 dual USB-C 45w	3	OPPAYH1PAC1C06MS	6 ft.	MS	700	
			OPPAYH1PAC1C06MW	6 ft.	MW	700	
			OPPAYH1PAC1C06MB	6 ft.	MB	700	
			OPPAYH1PAC1C10MS	10 ft.	MS	720	
			OPPAYH1PAC1C10MW	10 ft.	MW	720	
			OPPAYH1PAC1C10MB	10 ft.	MB	720	
		2 power, 1 USB-A+C	3	OPPAYH2PAC0D06MS	6 ft.	MS	510
				OPPAYH2PAC0D06MW	6 ft.	MW	510
				OPPAYH2PAC0D06MB	6 ft.	MB	510
				OPPAYH2PAC0D10MS	10 ft.	MS	530
				OPPAYH2PAC0D10MW	10 ft.	MW	530
				OPPAYH2PAC0D10MB	10 ft.	MB	530
	2 power, 1 dual charging USB-A	3	OPPAYH2P1A0D06MS	6 ft.	MS	510	
			OPPAYH2P1A0D06MW	6 ft.	MW	510	
			OPPAYH2P1A0D06MB	6 ft.	MB	510	
			OPPAYH2P1A0D10MS	10 ft.	MS	530	
			OPPAYH2P1A0D10MW	10 ft.	MW	530	
			OPPAYH2P1A0D10MB	10 ft.	MB	530	
	2 power, 1 dual charging USB-A, 1 open data	4	OPPAYH2P1A1D06MS	6 ft.	MS	510	
					MW	510	
					MB	510	
					MS	530	
					MW	530	
					MB	530	
OPPAYH2P1A1D10MS			10 ft.	MS	530		
				MW	530		
				MB	530		
				MS	530		
				MW	530		
				MB	530		
2 power, 1 dual charging USB-A, 1 USB-A+C	4	OPPAYH2P1AAC06MS	6 ft.	MS	610		
				MW	610		
				MB	610		
		OPPAYH2P1AAC10MS	10 ft.	MS	630		
				MW	630		
				MB	630		

Aya in surface cut out information:

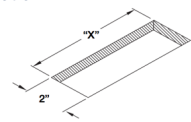
# of ports	"X" Dim.
4	6.75"W
6	9.75"W





### AYA SERIES FINISH CODE LEGEND:

-  **MS** - Matte storm plastic faceplate, clear anodized aluminum housing, black cord
-  **MW** - Matte white plastic faceplate, clear anodized aluminum housing, white cord
-  **MB** - Matte black plastic faceplate, clear anodized aluminum housing, black cord

\*\* Aya modules have many different configurations available within the family offering, including hardwired solutions, email [service@symphonytables.com](mailto:service@symphonytables.com) for assistance if you are looking for additional power/data/USB features for your project.

### AYA SERIES FINISH CODE LEGEND:

-  **MS** - Matte storm plastic faceplate, clear anodized aluminum housing, black cord
-  **MW** - Matte white plastic faceplate, clear anodized aluminum housing, white cord
-  **MB** - Matte black plastic faceplate, clear anodized aluminum housing, black cord

\*\* Aya modules have many different configurations available within the family offering, including hardwired solutions, email [service@symphonytables.com](mailto:service@symphonytables.com) for assistance if you are looking for additional power/data/USB features for your project.

# power/data modules

Beni in surface  
single-sided unit

module	description	# of ports	model no.	cord length	finish code	list
	2 power 4"D x 5"W table top cut out, specify location	2	OPP BEN2P0A0D06SS	6 ft.	SS	530
			OPP BEN2P0A0D06SW	6 ft.	SW	530
			OPP BEN2P0A0D06SB	6 ft.	SB	530
			OPP BEN2P0A0D10SS	10 ft.	SS	550
			OPP BEN2P0A0D10SW	10 ft.	SW	550
	OPP BEN2P0A0D10SB	10 ft.	SB	550		
	2 power, 1 dual charging USB-A 4"D x 6.5"W table top cut out, specify location	3	OPP BEN2P1A0D06SS	6 ft.	SS	650
			OPP BEN2P1A0D06SW	6 ft.	SW	650
			OPP BEN2P1A0D06SB	6 ft.	SB	650
			OPP BEN2P1A0D10SS	10 ft.	SS	670
			OPP BEN2P1A0D10SW	10 ft.	SW	670
	OPP BEN2P1A0D10SB	10 ft.	SB	670		
	2 power, 1 USB-A+C 4"D x 6.5"W table top cut out, specify location	3	OPP BEN2PAC0D06SS	6 ft.	SS	650
			OPP BEN2PAC0D06SW	6 ft.	SW	650
			OPP BEN2PAC0D06SB	6 ft.	SB	650
OPP BEN2PAC0D10SS			10 ft.	SS	670	
OPP BEN2PAC0D10SW			10 ft.	SW	670	
OPP BEN2PAC0D10SB	10 ft.	SB	670			
2 power, 1 dual charging USB-A, 1 USB-A+C 4"D x 8"W table top cut out, specify location	4	OPP BEN2P1AAC06SS	6 ft.	SS	790	
		OPP BEN2P1AAC06SW	6 ft.	SW	790	
		OPP BEN2P1AAC06SB	6 ft.	SB	790	
		OPP BEN2P1AAC10SS	10 ft.	SS	810	
		OPP BEN2P1AAC10SW	10 ft.	SW	810	
OPP BEN2P1AAC10SB	10 ft.	SB	810			
2 power, 1 USB-A+C, 1 dual USB-C 45w 4"D x 8"W table top cut out, specify location	4	OPP BEN2P1A1C06SS	6 ft.	SS	900	
		OPP BEN2P1A1C06SW	6 ft.	SW	900	
		OPP BEN2P1A1C06SB	6 ft.	SB	900	
		OPP BEN2P1A1C10SS	10 ft.	SS	920	
		OPP BEN2P1A1C10SW	10 ft.	SW	920	
OPP BEN2P1A1C10SB	10 ft.	SB	920			
2 power, 1 USB-A+C, 1 HDMI 4"D x 8"W table top cut out, specify location	4	OPP BEN2P1A1H06SS	6 ft.	SS	740	
		OPP BEN2P1A1H06SW	6 ft.	SW	740	
		OPP BEN2P1A1H06SB	6 ft.	SB	740	
		OPP BEN2P1A1H10SS	10 ft.	SS	760	
		OPP BEN2P1A1H10SW	10 ft.	SW	760	
OPP BEN2P1A1H10SB	10 ft.	SB	760			
2 power, 1 dual charging USB-A, 1 open data 4"D x 8"W table top cut out, specify location	4	OPP BEN2P1A1D06SS	6 ft.	SS	650	
		OPP BEN2P1A1D06SW	6 ft.	SW	650	
		OPP BEN2P1A1D06SB	6 ft.	SB	650	
		OPP BEN2P1A1D10SS	10 ft.	SS	670	
		OPP BEN2P1A1D10SW	10 ft.	SW	670	
OPP BEN2P1A1D10SB	10 ft.	SB	670			
2 power, 1 USB-A+C, 1 open data 4"D x 8"W table top cut out, specify location	4	OPP BEN2PAC1D06SS	6 ft.	SS	650	
		OPP BEN2PAC1D06SW	6 ft.	SW	650	
		OPP BEN2PAC1D06SB	6 ft.	SB	650	
		OPP BEN2PAC1D10SS	10 ft.	SS	670	
		OPP BEN2PAC1D10SW	10 ft.	SW	670	
OPP BEN2PAC1D10SB	10 ft.	SB	670			
2 power, 2 open data ports 4"D x 8"W table top cut out, specify location	4	OPP BEN2P0A2D06SS	6 ft.	SS	540	
		OPP BEN2P0A2D06SW	6 ft.	SW	540	
		OPP BEN2P0A2D06SB	6 ft.	SB	540	
		OPP BEN2P0A2D10SS	10 ft.	SS	560	
		OPP BEN2P0A2D10SW	10 ft.	SW	560	
OPP BEN2P0A2D10SB	10 ft.	SB	560			
2 power, 1 dual charging USB-A, 3 open data 4"D x 11"W table top cut out, specify location	6	OPP BEN2P1A3D06SS	6 ft.	SS	720	
		OPP BEN2P1A3D06SW	6 ft.	SW	720	
		OPP BEN2P1A3D06SB	6 ft.	SB	720	
		OPP BEN2P1A3D10SS	10 ft.	SS	740	
		OPP BEN2P1A3D10SW	10 ft.	SW	740	
OPP BEN2P1A3D10SB	10 ft.	SB	740			
3 power, 3 open data ports 4"D x 11"W table top cut out, specify location	6	OPP BEN3P0A3D06SS	6 ft.	SS	580	
		OPP BEN3P0A3D06SW	6 ft.	SW	580	
		OPP BEN3P0A3D06SB	6 ft.	SB	580	
		OPP BEN3P0A3D10SS	10 ft.	SS	600	
		OPP BEN3P0A3D10SW	10 ft.	SW	600	
OPP BEN3P0A3D10SB	10 ft.	SB	600			

**BENI SERIES FINISH CODE LEGEND:**

- SS** - Silver anodized aluminum case finish, silver trim finish, black simplex finish, black cord
- SW** - Silver anodized aluminum case finish, white trim finish, white simplex finish, white cord
- SB** - Silver anodized aluminum case finish, black trim finish, black simplex finish, black cord

**Beni in surface single-sided cut out information:**

# of ports	"X" Dim.
2	5"
3	6.5"
4	8"
6	11"

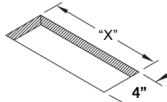

\*\* Beni has many different configurations available within the family offering, including a hardwired solution, shared media solutions and upgraded equipment that will allow the units to daisy chain (for an upcharge), email [service@symphonytables.com](mailto:service@symphonytables.com) for assistance if you are looking for additional power/data/USB features for your project.

# power/data modules

Beni in surface  
back-to-back and side-to-side

module	description	# of ports	model no.	cord length	finish code	list
	Each side contains: 2 power, 1 USB-A+C, 1 open data total of 4 power, 2 USB-A+C, 2 open data per unit 7-11/16"D x 8"W table top cut out, specify location	8 (4/side)	OPP BEB4P2AC2D06SS	6 ft.	SS	1,350
			OPP BEB4P2AC2D06SW	6 ft.	SW	1,350
			OPP BEB4P2AC2D06SB	6 ft.	SB	1,350
			OPP BEB4P2AC2D10SS	10 ft.	SS	1,370
			OPP BEB4P2AC2D10SW	10 ft.	SW	1,370
	OPP BEB4P2AC2D10SB	10 ft.	SB	1,370		
	Each side contains: 2 power, 1 dual charging USB-A, 1 open data total of 4 power, 2 USB-A+C, 2 open data per unit 7-11/16"D x 8"W table top cut out, specify location	8 (4/side)	OPP BEB4P2A2D06SS	6 ft.	SS	1,350
			OPP BEB4P2A2D06SW	6 ft.	SW	1,350
			OPP BEB4P2A2D06SB	6 ft.	SB	1,350
			OPP BEB4P2A2D10SS	10 ft.	SS	1,370
			OPP BEB4P2A2D10SW	10 ft.	SW	1,370
	OPP BEB4P2A2D10SB	10 ft.	SB	1,370		
	Each side contains: 2 power, 2 open data ports total of 4 power, 4 open data ports per unit 7-11/16"D x 8"W table top cut out, specify location	8 (4/side)	OPP BEB4P0A4D06SS	6 ft.	SS	1,090
			OPP BEB4P0A4D06SW	6 ft.	SW	1,090
			OPP BEB4P0A4D06SB	6 ft.	SB	1,090
OPP BEB4P0A4D10SS			10 ft.	SS	1,110	
OPP BEB4P0A4D10SW			10 ft.	SW	1,110	
OPP BEB4P0A4D10SB	10 ft.	SB	1,110			
Each side contains: 2 power, 1 USB-A+C, 1 dual USB-C 45w total of 4 power, 2 USB-A+C, 2 USB-C 45w per unit 7-11/16"D x 8"W table top cut out, specify location	8 (4/side)	OPP BEB4P2AC2C06SS	6 ft.	SS	1,740	
		OPP BEB4P2AC2C06SW	6 ft.	SW	1,740	
		OPP BEB4P2AC2C06SB	6 ft.	SB	1,740	
		OPP BEB4P2AC2C10SS	10 ft.	SS	1,760	
		OPP BEB4P2AC2C10SW	10 ft.	SW	1,760	
OPP BEB4P2AC2C10SB	10 ft.	SB	1,760			
Side 1 contains: 2 power, 1 USB-A+C, 1 HDMI Side 2 contains: 2 power, 1 USB-A+C, 1 open data total of 4 power, 2 USB-A+C, 1 HDMI, 1 open data per unit 7-11/16"D x 8"W table top cut out, specify location	8 (4/side)	OPP BEB4P2AC1H1D06SS	6 ft.	SS	1,430	
		OPP BEB4P2AC1H1D06SW	6 ft.	SW	1,430	
		OPP BEB4P2AC1H1D06SB	6 ft.	SB	1,430	
		OPP BEB4P2AC1H1D10SS	10 ft.	SS	1,450	
		OPP BEB4P2AC1H1D10SW	10 ft.	SW	1,450	
OPP BEB4P2AC1H1D10SB	10 ft.	SB	1,450			

**Beni Back-To-Back cut out information:**

# of ports	"X" Dim.	# Ports Per Side (Back to Back)
8 (4 ports / side)	8"	

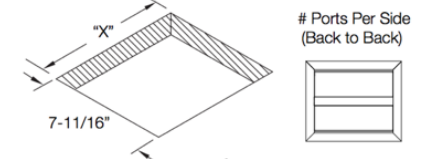

**Beni in surface side-to-side unit**  
(there are 2 cords standard per unit)

	Each side contains: 2 power, 2 open data ports total of 4 power, 4 open data ports per unit 4"D x 16-3/16"W table top cut out, specify location	8 (4/side)	OPP BES4P0A4D06SS	6 ft.	SS	1,170
			OPP BES4P0A4D06SW	6 ft.	SW	1,170
			OPP BES4P0A4D06SB	6 ft.	SB	1,170
			OPP BES4P0A4D10SS	10 ft.	SS	1,190
			OPP BES4P0A4D10SW	10 ft.	SW	1,190
OPP BES4P0A4D10SB	10 ft.	SB	1,190			
Each side contains: 3 power, 3 open data ports total of 6 power, 6 open data ports per unit 4"D x 22-3/16"W table top cut out, specify location	12 (6/side)	OPP BES6P0A6D06SS	6 ft.	SS	1,290	
		OPP BES6P0A6D06SW	6 ft.	SW	1,290	
		OPP BES6P0A6D06SB	6 ft.	SB	1,290	
		OPP BES6P0A6D10SS	10 ft.	SS	1,310	
		OPP BES6P0A6D10SW	10 ft.	SW	1,310	
OPP BES6P0A6D10SB	10 ft.	SB	1,310			

**Beni Side-By-Side cut out information:**

# of ports	"X" Dim.	# Ports Per Side (Side by Side)
8 (4 ports / side)	16-3/16"W	
12 (6 ports / side)	22-3/16"W	



**BENI SERIES FINISH CODE LEGEND:**

- SS** - Silver anodized aluminum case finish, silver trim finish, black simplex finish, black cord
- SW** - Silver anodized aluminum case finish, white trim finish, white simplex finish, white cord
- SB** - Silver anodized aluminum case finish, black trim finish, black simplex finish, black cord

\*\* Beni back-to-back and side-to-side units are also available with a single circuit breaker cord instead of 2 cords per unit, please email [service@symphonytables.com](mailto:service@symphonytables.com) for pricing.  
\*\* Beni has many different configurations available within the family offering, including a hardwired solution, shared media solutions and upgraded equipment that will allow the units to daisy chain (for an upcharge), email [service@symphonytables.com](mailto:service@symphonytables.com) for assistance if you are looking for additional power/data/USB features for your project.

# power/data modules

Circo in surface and Cova Shared Media

module	description	# of ports	model no.	cord length	finish code	list
Circo in surface	2 power 3" diameter cut out, specify location	2	OPPCIR2P0A0D06MF	6 ft.	MF	290
			OPPCIR2P0A0D06MS	6 ft.	MS	290
			OPPCIR2P0A0D06MW	6 ft.	MW	290
			OPPCIR2P0A0D06MB	6 ft.	MB	290
			OPPCIR2P0A0D10MF	10 ft.	MF	310
			OPPCIR2P0A0D10MS	10 ft.	MS	310
	1 power, 1 dual charging USB-A 3" diameter cut out, specify location	2	OPPCIR1P1A0D06MF	6 ft.	MF	380
			OPPCIR1P1A0D06MS	6 ft.	MS	380
			OPPCIR1P1A0D06MW	6 ft.	MW	380
			OPPCIR1P1A0D06MB	6 ft.	MB	380
			OPPCIR1P1A0D10MF	10 ft.	MF	400
			OPPCIR1P1A0D10MS	10 ft.	MS	400
1 power, 1 USB-A+C 3" diameter cut out, specify location	2	OPPCIR1PAC0D06MF	6 ft.	MF	380	
		OPPCIR1PAC0D06MS	6 ft.	MS	380	
		OPPCIR1PAC0D06MW	6 ft.	MW	380	
		OPPCIR1PAC0D06MB	6 ft.	MB	380	
		OPPCIR1PAC0D10MF	10 ft.	MF	400	
		OPPCIR1PAC0D10MS	10 ft.	MS	400	
Circo in surface	2 power, 1 convenience outlet below the worksurface 3" diameter cut out, specify location	2	OPPCIR2P0A0D106MF	6 ft.	MF	310
			OPPCIR2P0A0D106MS	6 ft.	MS	310
			OPPCIR2P0A0D106MW	6 ft.	MW	310
			OPPCIR2P0A0D106MB	6 ft.	MB	310
			OPPCIR2P0A0D110MF	10 ft.	MF	330
			OPPCIR2P0A0D110MS	10 ft.	MS	330
	1 power, 1 dual charging USB-A, 1 convenience outlet below the worksurface 3" diameter cut out, specify location	2	OPPCIR1P1A0D106MF	6 ft.	MF	400
			OPPCIR1P1A0D106MS	6 ft.	MS	400
			OPPCIR1P1A0D106MW	6 ft.	MW	400
			OPPCIR1P1A0D106MB	6 ft.	MB	400
			OPPCIR1P1A0D110MF	10 ft.	MF	420
			OPPCIR1P1A0D110MS	10 ft.	MS	420
1 power, 1 USB-A+C, 1 convenience outlet below the worksurface 3" diameter cut out, specify location	2	OPPCIR1PAC0D106MF	6 ft.	MF	400	
		OPPCIR1PAC0D106MS	6 ft.	MS	400	
		OPPCIR1PAC0D106MW	6 ft.	MW	400	
		OPPCIR1PAC0D106MB	6 ft.	MB	400	
		OPPCIR1PAC0D110MF	10 ft.	MF	420	
		OPPCIR1PAC0D110MS	10 ft.	MS	420	

Circo in surface cut out information:

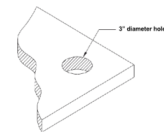

CIRCO SERIES FINISH CODE LEGEND:

- ME** - Matte Fog powdercoat finish, fog simplex finish, black cord
- MS** - Matte Storm powdercoat finish, storm simplex finish, black cord
- MW** - Matte White powdercoat finish, white simplex finish, white cord (black portion shown in image will screw in under the table top)
- MB** - Matte Black powdercoat finish, black simplex finish, black cord

## Cova Shared Media

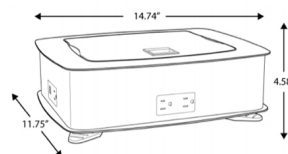

4 power, 2 dual charging USB-A, 4 HDMI Show Me cables, HDMI 4 position switch box, 15' HDMI monitor cable Carry case included.

Ideal for a portable shared media solution with easy set up additional adapter accessories available email service@symphonytables.com for assistance.

N/A	OPPCOV4P4H2U9BB	9 ft.	BB	11,650
	OPPCOV4P4H2U9SS	9 ft.	SS	11,650
	OPPCOV4P4H2U9WW	9 ft.	WW	11,650

COVA SERIES FINISH CODE LEGEND:

- BB** - black
- SS** - silver
- WW** - white

# power/data modules

Doca freestanding and in surface and Felino in surface

module	description	# of ports	model no.	cord length	finish code	list
Doca freestanding	2 power, 1 dual charging USB-A, one blank no cut out required	4	OPPDO2P1A1B06GB	6 ft.	GB	460
			OPPDO2P1A1B06GW	6 ft.	GW	460
			OPPDO2P1A1B10GB	10 ft.	GB	480
	2 power, 1 USB-A+C, one blank no cut out required	4	OPPDO2PAC1B06GB	6 ft.	GB	460
			OPPDO2PAC1B06GW	6 ft.	GW	460
			OPPDO2PAC1B10GB	10 ft.	GB	480
Doca in surface	3 power, 1 dual charging USB-A 3" diameter cut out, specify location	4	OPPDO3P1A0D06GB	6 ft.	GB	470
			OPPDO3P1A0D06GW	6 ft.	GW	470
			OPPDO3P1A0D10GB	10 ft.	GB	490
	2 power, 2 dual charging USB-A 3" diameter cut out, specify location	4	OPPDO2P2A0D06GB	6 ft.	GB	580
			OPPDO2P2A0D06GW	6 ft.	GW	580
			OPPDO2P2A0D10GB	10 ft.	GB	600
	3 power, 1 USB-A+C 3" diameter cut out, specify location	4	OPPDO3PAC0D06GB	6 ft.	GB	470
			OPPDO3PAC0D06GW	6 ft.	GW	470
			OPPDO3PAC0D10GB	10 ft.	GB	490
	2 power, 2 USB-A+C 3" diameter cut out, specify location	4	OPPDO2P2AC06GB	6 ft.	GB	580
			OPPDO2P2AC06GW	6 ft.	GW	580
			OPPDO2P2AC10GB	10 ft.	GB	600
Felino in surface	3 power 4.5" diameter cut out required, specify location	3	OPPFEL3P0A0D06FF	6 ft.	FF	390
			OPPFEL3P0A0D06SS	6 ft.	SS	390
			OPPFEL3P0A0D06WW	6 ft.	WW	390
			OPPFEL3P0A0D06BB	6 ft.	BB	390
			OPPFEL3P0A0D10FF	10 ft.	FF	410
			OPPFEL3P0A0D10SS	10 ft.	SS	410
	2 power, 1 dual charging USB-A 4.5" diameter cut out required, specify location	3	OPPFEL2P1A0D06FF	6 ft.	FF	480
			OPPFEL2P1A0D06SS	6 ft.	SS	480
			OPPFEL2P1A0D06WW	6 ft.	WW	480
			OPPFEL2P1A0D06BB	6 ft.	BB	480
			OPPFEL2P1A0D10FF	10 ft.	FF	500
			OPPFEL2P1A0D10SS	10 ft.	SS	500
2 power, 1 USB-A+C, one blank 4.5" diameter cut out required, specify location	3	OPPFEL2PAC0D06FF	6 ft.	FF	480	
		OPPFEL2PAC0D06SS	6 ft.	SS	480	
		OPPFEL2PAC0D06WW	6 ft.	WW	480	
		OPPFEL2PAC0D06BB	6 ft.	BB	480	
		OPPFEL2PAC0D10FF	10 ft.	FF	500	
		OPPFEL2PAC0D10SS	10 ft.	SS	500	

Doca in surface cut out information:

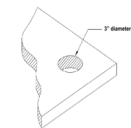

DOCA SERIES FINISH CODE LEGEND:

- GW** - Gloss white case finish, white trim finish, white simplex finish, molded white custom insert, white cord
- GB** - Gloss black case finish, black trim finish, black simplex finish, molded black custom insert, black cord

\*\* Doca modules have many different configurations available within the family offering, including hardwired solutions, email service@symphonytables.com for assistance if you are looking for additional power/data/USB features for your project.

## Felino in surface



Felino SERIES FINISH CODE LEGEND:

- FE** - Soft touch fog plastic finish
- SS** - Soft touch storm plastic finish
- WW** - Soft touch white plastic finish
- BB** - Soft touch black plastic finish

Felino in surface cut out information:

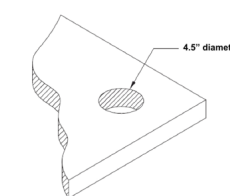



# power/data modules

Fola edge mount, Fyx and Gazzo freestanding

module	description	# of ports	model no.	cord length	finish code	list
Fola edge mount with clamp	2 power, 1 dual charging USB-A	3	OPPFOL2P1A0D06ST	6 ft.	ST	500
			OPPFOL2P1A0D06SW	6 ft.	SW	500
			OPPFOL2P1A0D06SB	6 ft.	SB	500
			OPPFOL2P1A0D10ST	10 ft.	ST	520
			OPPFOL2P1A0D10SW	10 ft.	SW	520
			OPPFOL2P1A0D10SB	10 ft.	SB	520
	2 power, 1 dual charging USB-A, 1 USB-A+C	4	OPPFOL2P1AAC06ST	6 ft.	ST	630
			OPPFOL2P1AAC06SW	6 ft.	SW	630
			OPPFOL2P1AAC06SB	6 ft.	SB	630
			OPPFOL2P1AAC10ST	10 ft.	ST	650
			OPPFOL2P1AAC10SW	10 ft.	SW	650
			OPPFOL2P1AAC10SB	10 ft.	SB	650
	3 power, 1 open data	4	OPPFOL3P0A1D06ST	6 ft.	ST	390
			OPPFOL3P0A1D06SW	6 ft.	SW	390
			OPPFOL3P0A1D06SB	6 ft.	SB	390
			OPPFOL3P0A1D10ST	10 ft.	ST	410
			OPPFOL3P0A1D10SW	10 ft.	SW	410
			OPPFOL3P0A1D10SB	10 ft.	SB	410
3 power, 1 dual charging USB-A	4	OPPFOL3P1A0D06ST	6 ft.	ST	520	
		OPPFOL3P1A0D06SW	6 ft.	SW	520	
		OPPFOL3P1A0D06SB	6 ft.	SB	520	
		OPPFOL3P1A0D10ST	10 ft.	ST	540	
		OPPFOL3P1A0D10SW	10 ft.	SW	540	
		OPPFOL3P1A0D10SB	10 ft.	SB	540	
3 power, 1 USB-A+C	4	OPPFOL3PAC0D06ST	6 ft.	ST	520	
		OPPFOL3PAC0D06SW	6 ft.	SW	520	
		OPPFOL3PAC0D06SB	6 ft.	SB	520	
		OPPFOL3PAC0D10ST	10 ft.	ST	540	
		OPPFOL3PAC0D10SW	10 ft.	SW	540	
		OPPFOL3PAC0D10SB	10 ft.	SB	540	
2 power, 1 USB-A+C, 1 dual USB-C 45w	4	OPPFOL2PAC1C06ST	6 ft.	ST	740	
		OPPFOL2PAC1C06SW	6 ft.	SW	740	
		OPPFOL2PAC1C06SB	6 ft.	SB	740	
		OPPFOL2PAC1C10ST	10 ft.	ST	760	
		OPPFOL2PAC1C10SW	10 ft.	SW	760	
		OPPFOL2PAC1C10SB	10 ft.	SB	760	

**FOLA SERIES FINISH CODE LEGEND:**



- ST** - Silver anodized aluminum case finish, storm trim and simplex finish, black cord
- SW** - Silver anodized aluminum case finish, white trim and simplex finish, white cord
- SB** - Silver anodized aluminum case finish, black trim and simplex finish, black cord

module	description	# of ports	model no.	cord length	finish code	list
Fyx Freestanding	6 power, 48" long unit	6	OPPFYX6P0A0D06SW	6 ft.	SW	750
			OPPFYX6P0A0D10SW	10 ft.	SW	770
Gazzo Freestanding	2 USB-A single ports, 1 USB-C	3	OPPGAZ0P2A1CSS	N/A	SS	620
			OPPGAZ0P2A1CWB	N/A	WB	620
Gazzo Freestanding	2 USB-A single ports, 1 USB-C	3	OPPGAZ0P2A1CBB	N/A	BB	620
			OPPGAZ0P2A1CWB	N/A	WB	620

**GAZZO SERIES FINISH CODE LEGEND:**

- SS** - Storm
- WB** - White
- BB** - Black

# power/data modules

Kita single-sided in surface

module	description	# of ports	model no.	cord length	finish code	list
Kita in surface single-sided unit	2 power, 1 dual charging USB-A, 1 open data port 5"D x 8"W table top cut out, specify location	4	OPPKIT2P1A1D06ST	6 ft.	ST	740
			OPPKIT2P1A1D06SW	6 ft.	SW	740
			OPPKIT2P1A1D06SB	6 ft.	SB	740
			OPPKIT2P1A1D10ST	10 ft.	ST	760
			OPPKIT2P1A1D10SW	10 ft.	SW	760
			OPPKIT2P1A1D10SB	10 ft.	SB	760
	2 power, 1 USB-A+C, 1 open data port 5"D x 8"W table top cut out, specify location	4	OPPKIT2PAC1D06ST	6 ft.	ST	740
			OPPKIT2PAC1D06SW	6 ft.	SW	740
			OPPKIT2PAC1D06SB	6 ft.	SB	740
			OPPKIT2PAC1D10ST	10 ft.	ST	760
			OPPKIT2PAC1D10SW	10 ft.	SW	760
			OPPKIT2PAC1D10SB	10 ft.	SB	760
	2 power, 1 dual charging USB-A, 1 HDMI 5"D x 8"W table top cut out, specify location	4	OPPKIT2P1A1H06ST	6 ft.	ST	830
			OPPKIT2P1A1H06SW	6 ft.	SW	830
			OPPKIT2P1A1H06SB	6 ft.	SB	830
			OPPKIT2P1A1H10ST	10 ft.	ST	850
			OPPKIT2P1A1H10SW	10 ft.	SW	850
			OPPKIT2P1A1H10SB	10 ft.	SB	850
	2 power, 1 USB-A+C, 1 HDMI 5"D x 8"W table top cut out, specify location	4	OPPKIT2PAC1H06ST	6 ft.	ST	830
			OPPKIT2PAC1H06SW	6 ft.	SW	830
			OPPKIT2PAC1H06SB	6 ft.	SB	830
			OPPKIT2PAC1H10ST	10 ft.	ST	850
			OPPKIT2PAC1H10SW	10 ft.	SW	850
			OPPKIT2PAC1H10SB	10 ft.	SB	850
3 power, 1 open data port 5"D x 8"W table top cut out, specify location	4	OPPKIT3P0A1D06ST	6 ft.	ST	600	
		OPPKIT3P0A1D06SW	6 ft.	SW	600	
		OPPKIT3P0A1D06SB	6 ft.	SB	600	
		OPPKIT3P0A1D10ST	10 ft.	ST	620	
		OPPKIT3P0A1D10SW	10 ft.	SW	620	
		OPPKIT3P0A1D10SB	10 ft.	SB	620	
2 power, 2 open data ports 5"D x 8"W table top cut out, specify location	4	OPPKIT2P0A2D06ST	6 ft.	ST	620	
		OPPKIT2P0A2D06SW	6 ft.	SW	620	
		OPPKIT2P0A2D06SB	6 ft.	SB	620	
		OPPKIT2P0A2D10ST	10 ft.	ST	640	
		OPPKIT2P0A2D10SW	10 ft.	SW	640	
		OPPKIT2P0A2D10SB	10 ft.	SB	640	
3 power, 1 dual charging USB-A, 2 open data ports 5"D x 11"W table top cut out, specify location	6	OPPKIT3P1A2D06ST	6 ft.	ST	750	
		OPPKIT3P1A2D06SW	6 ft.	SW	750	
		OPPKIT3P1A2D06SB	6 ft.	SB	750	
		OPPKIT3P1A2D10ST	10 ft.	ST	770	
		OPPKIT3P1A2D10SW	10 ft.	SW	770	
		OPPKIT3P1A2D10SB	10 ft.	SB	770	
3 power, 3 open data ports 5"D x 11"W table top cut out, specify location	6	OPPKIT3P0A3D06ST	6 ft.	ST	650	
		OPPKIT3P0A3D06SW	6 ft.	SW	650	
		OPPKIT3P0A3D06SB	6 ft.	SB	650	
		OPPKIT3P0A3D10ST	10 ft.	ST	670	
		OPPKIT3P0A3D10SW	10 ft.	SW	670	
		OPPKIT3P0A3D10SB	10 ft.	SB	670	
2 power, 1 USB-A+C, 1 dual USB-C 45w, 2 open data ports 5"D x 11"W table top cut out, specify location	6	OPPKIT2PAC1C2D06ST	6 ft.	ST	980	
		OPPKIT2PAC1C2D06SW	6 ft.	SW	980	
		OPPKIT2PAC1C2D06SB	6 ft.	SB	980	
		OPPKIT2PAC1C2D10ST	10 ft.	ST	1,000	
		OPPKIT2PAC1C2D10SW	10 ft.	SW	1,000	
		OPPKIT2PAC1C2D10SB	10 ft.	SB	1,000	

**Kita SINGLE SIDED cut out information:**

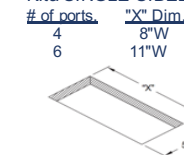

**KITA SERIES FINISH CODE LEGEND:**



- ST** - Silver anodized aluminum case finish, storm trim and simplex finish, black cord
- SW** - Silver anodized aluminum case finish, white trim and simplex finish, black cord
- SB** - Silver anodized aluminum case finish, black trim and simplex finish, black cord

\*\* Kita has many different configurations available within the family offering, including a hardwired solution, shared media solutions and upgraded equipment that will allow the units to daisy chain (for an upcharge), email [service@symphonytables.com](mailto:service@symphonytables.com) for assistance if you are looking for additional power/data/USB features for your project.

# power/data modules

## Kita in surface back-to-back

module	description	# of ports	model no.	cord length	finish code	list
<b>Kita back-to-back unit (there are 2 cords standard per unit)</b>						
	Each side contains: 3 power, 1 open data port	8 (4/side)	OPPKIB6P0A2D06ST OPPKIB6P0A2D06SW OPPKIB6P0A2D06SB	6 ft. 6 ft. 6 ft.	ST SW SB	1,060 1,060 1,060
	Total of 6 power, 2 open data ports per unit		OPPKIB6P0A2D10ST OPPKIB6P0A2D10SW OPPKIB6P0A2D10SB	10 ft. 10 ft. 10 ft.	ST SW SB	1,080 1,080 1,080
	9-13/16"D x 8"W table top cut out					
	Each side contains: 2 power, 1 USB-A+C, 1 open data port	8 (4/side)	OPPKIB4P2AC2D06ST OPPKIB4P2AC2D06SW OPPKIB4P2AC2D06SB	6 ft. 6 ft. 6 ft.	ST SW SB	1,300 1,300 1,300
Total of 4 power, 2 USB-A+C, 2 open data ports per unit		OPPKIB4P2AC2D10ST OPPKIB4P2AC2D10SW OPPKIB4P2AC2D10SB	10 ft. 10 ft. 10 ft.	ST SW SB	1,320 1,320 1,320	
9-13/16"D x 8"W table top cut out						
Each side contains: 2 power, 1 dual charging USB-A, 1 open data port	8 (4/side)	OPPKIB4P2A2D06ST OPPKIB4P2A2D06SW OPPKIB4P2A2D06SB	6 ft. 6 ft. 6 ft.	ST SW SB	1,300 1,300 1,300	
Total of 4 power, 2 dual charging USB-A, 2 open data ports per unit		OPPKIB4P2A2D10ST OPPKIB4P2A2D10SW OPPKIB4P2A2D10SB	10 ft. 10 ft. 10 ft.	ST SW SB	1,320 1,320 1,320	
9-13/16"D x 8"W table top cut out						
Each side contains: 2 power, 2 open data ports	8 (4/side)	OPPKIB4P0A4D06ST OPPKIB4P0A4D06SW OPPKIB4P0A4D06SB	6 ft. 6 ft. 6 ft.	ST SW SB	1,060 1,060 1,060	
Total of 4 power, 4 open data ports per unit		OPPKIB4P0A4D10ST OPPKIB4P0A4D10SW OPPKIB4P0A4D10SB	10 ft. 10 ft. 10 ft.	ST SW SB	1,080 1,080 1,080	
9-13/16"D x 8"W table top cut out						
Side 1 contains: 2 power, 1 USB-A+C, 1 open data Side 2 contains: 2 power 1 USB-A+C, 1 HDMI	8 (4/side)	OPPKIB4P2AC1D1H06ST OPPKIB4P2AC1D1H06SW OPPKIB4P2AC1D1H06SB	6 ft. 6 ft. 6 ft.	ST SW SB	1,490 1,490 1,490	
Total of 4 power 2 USB-A+C, 1 open data, 1 HDMI per unit		OPPKIB4P2AC1D1H10ST OPPKIB4P2AC1D1H10SW OPPKIB4P2AC1D1H10SB	10 ft. 10 ft. 10 ft.	ST SW SB	1,510 1,510 1,510	
9-13/16"D x 8"W table top cut out						
Side 1 contains: 2 power, 1 dual charging USB-A, 1 open data Side 2 contains: 2 power, 1 dual charging USB-A, 1 HDMI	8 (4/side)	OPPKIB4P2A1D1H06ST OPPKIB4P2A1D1H06SW OPPKIB4P2A1D1H06SB	6 ft. 6 ft. 6 ft.	ST SW SB	1,490 1,490 1,490	
Total of 4 power 2 dual USB-A, 1 open data, 1 HDMI per unit		OPPKIB4P2A1D1H10ST OPPKIB4P2A1D1H10SW OPPKIB4P2A1D1H10SB	10 ft. 10 ft. 10 ft.	ST SW SB	1,510 1,510 1,510	
9-13/16"D x 8"W table top cut out						
Each side contains: 3 power, 3 open data ports	12 (6/side)	OPPKIB6P0A6D06ST OPPKIB6P0A6D06SW OPPKIB6P0A6D06SB	6 ft. 6 ft. 6 ft.	ST SW SB	1,180 1,180 1,180	
Total of 6 power, 6 open data ports per unit		OPPKIB6P0A6D10ST OPPKIB6P0A6D10SW OPPKIB6P0A6D10SB	10 ft. 10 ft. 10 ft.	ST SW SB	1,200 1,200 1,200	
9-13/16"D x 11"W table top cut out						
Each side contains: 3 power, 1 dual charging USB-A, 2 open data ports	12 (6/side)	OPPKIB6P2A4D06ST OPPKIB6P2A4D06SW OPPKIB6P2A4D06SB	6 ft. 6 ft. 6 ft.	ST SW SB	1,420 1,420 1,420	
Total of 6 power, 2 dual charging USB-A, 4 open data ports per unit		OPPKIB6P2A4D10ST OPPKIB6P2A4D10SW OPPKIB6P2A4D10SB	10 ft. 10 ft. 10 ft.	ST SW SB	1,440 1,440 1,440	
9-13/16"D x 11"W table top cut out						
Each side contains: 3 power, 1 USB-A+C, 2 open data ports	12 (6/side)	OPPKIB6P2AC4D06ST OPPKIB6P2AC4D06SW OPPKIB6P2AC4D06SB	6 ft. 6 ft. 6 ft.	ST SW SB	1,470 1,470 1,470	
Total of 6 power, 2 USB-A+C, 4 open data ports per unit		OPPKIB6P2AC4D10ST OPPKIB6P2AC4D10SW OPPKIB6P2AC4D10SB	10 ft. 10 ft. 10 ft.	ST SW SB	1,490 1,490 1,490	
9-13/16"D x 11"W table top cut out						
Each side contains: 2 power, 1 USB-A+C, 1 dual USB-C 45W, 2 open data ports	12 (6/side)	OPPKIB4P2AC2C4D06ST OPPKIB4P2AC2C4D06SW OPPKIB4P2AC2C4D06SB	6 ft. 6 ft. 6 ft.	ST SW SB	1,850 1,850 1,850	
Total of 4 power, 2 USB-A+C, 2 dual USB-C 45W, 4 open data ports per unit		OPPKIB4P2AC2C4D10ST OPPKIB4P2AC2C4D10SW OPPKIB4P2AC2C4D10SB	10 ft. 10 ft. 10 ft.	ST SW SB	1,870 1,870 1,870	
9-13/16"D x 11"W table top cut out						
Side 1 contains: 3 power, 1 USB-A+C, 2 open data ports Side 2 contains: 3 power, 1 USB-A+C, 1 open data, 1 HDMI	12 (6/side)	OPPKIB6P2AC3D1H06ST OPPKIB6P2AC3D1H06SW OPPKIB6P2AC3D1H06SB	6 ft. 6 ft. 6 ft.	ST SW SB	1,550 1,550 1,550	
Total of 6 power, 2 USB-A+C, 3 open data ports, 1 HDMI per unit		OPPKIB6P2AC3D1H10ST OPPKIB6P2AC3D1H10SW OPPKIB6P2AC3D1H10SB	10 ft. 10 ft. 10 ft.	ST SW SB	1,570 1,570 1,570	
9-13/16"D x 11"W table top cut out						

Kita Back-To-Back cut out information:

# of ports: 8  
(4 ports / side)  
"X" Dim: 8"W  
12  
(6 ports / side)  
11"W

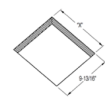

KITA SERIES FINISH CODE LEGEND:

ST - Silver anodized aluminum case finish, storm trim and simplex finish, black cord  
SW - Silver anodized aluminum case finish, white trim and simplex finish, black cord  
SB - Silver anodized aluminum case finish, black trim and simplex finish, black cord

\*Kita back-to-back units are also available with a single circuit breaker cord instead of 2 cords per unit, please email service@symphonytables.com for pricing.  
\*\* Kita has many different configurations available within the family offering, including a hardwired solution, shared media solutions and upgraded equipment that will allow the units to daisy chain (for an upcharge), email service@symphonytables.com for assistance if you are looking for additional power/data/USB features for your project.

# power/data modules

## Kita II single-sided in surface

module	description	# of ports	model no.	cord length	finish code	list
<b>Kita II in surface single-sided unit</b>						
	2 power, 1 dual charging USB-A, 1 open data port 4-7/8"D x 7-7/8"W table top cut out, specify location	4	OPPKI22P1A1D06MS OPPKI22P1A1D06MW OPPKI22P1A1D06MB	6 ft. 6 ft. 6 ft.	MS MW MB	610 610 610
			OPPKI22P1A1D10MS OPPKI22P1A1D10MW OPPKI22P1A1D10MB	10 ft. 10 ft. 10 ft.	MS MW MB	630 630 630
	2 power, 1 USB-A+C, 1 open data port 4-7/8"D x 7-7/8"W table top cut out, specify location	4	OPPKI22PAC1D06MS OPPKI22PAC1D06MW OPPKI22PAC1D06MB	6 ft. 6 ft. 6 ft.	MS MW MB	610 610 610
			OPPKI22PAC1D10MS OPPKI22PAC1D10MW OPPKI22PAC1D10MB	10 ft. 10 ft. 10 ft.	MS MW MB	630 630 630
2 power, 1 dual charging USB-A, 1 HDMI 4-7/8"D x 7-7/8"W table top cut out, specify location	4	OPPKI22P1A1H06MS OPPKI22P1A1H06MW OPPKI22P1A1H06MB	6 ft. 6 ft. 6 ft.	MS MW MB	700 700 700	
		OPPKI22P1A1H10MS OPPKI22P1A1H10MW OPPKI22P1A1H10MB	10 ft. 10 ft. 10 ft.	MS MW MB	720 720 720	
2 power, 1 USB-A+C, 1 HDMI 4-7/8"D x 7-7/8"W table top cut out, specify location	4	OPPKI22PAC1H06MS OPPKI22PAC1H06MW OPPKI22PAC1H06MB	6 ft. 6 ft. 6 ft.	MS MW MB	700 700 700	
		OPPKI22PAC1H10MS OPPKI22PAC1H10MW OPPKI22PAC1H10MB	10 ft. 10 ft. 10 ft.	MS MW MB	720 720 720	
2 power, 1 USB-A+C, 1 dual USB-C 45w 4-7/8"D x 7-7/8"W table top cut out, specify location	4	OPPKI22PAC1C06MS OPPKI22PAC1C06MW OPPKI22PAC1C06MB	6 ft. 6 ft. 6 ft.	MS MW MB	830 830 830	
		OPPKI22PAC1C10MS OPPKI22PAC1C10MW OPPKI22PAC1C10MB	10 ft. 10 ft. 10 ft.	MS MW MB	850 850 850	
<b>Kita II + WIRELESS in surface single-sided unit</b>						
	3 power, 1 dual charging USB-A, 3 Qi coils 4-7/8" x 10-7/8" table top cut out, specify location Note that the wireless unit required a total of 6 ports	6	OPPKIW3P1A0D06MS OPPKIW3P1A0D06MW OPPKIW3P1A0D06MB	6 ft. 6 ft. 6 ft.	MS MW MB	1,120 1,120 1,120
			OPPKIW3P1A0D10MS OPPKIW3P1A0D10MW OPPKIW3P1A0D10MB	10 ft. 10 ft. 10 ft.	MS MW MB	1,140 1,140 1,140
	2 power, 1 USB-A+C, 1 open data port, 3 Qi coils 4-7/8" x 10-7/8" table top cut out, specify location Note that the wireless unit required a total of 6 ports	6	OPPKIW2PAC1D06MS OPPKIW2PAC1D06MW OPPKIW2PAC1D06MB	6 ft. 6 ft. 6 ft.	MS MW MB	1,110 1,110 1,110
			OPPKIW2PAC1D10MS OPPKIW2PAC1D10MW OPPKIW2PAC1D10MB	10 ft. 10 ft. 10 ft.	MS MW MB	1,130 1,130 1,130
2 power, 1 dual charging USB-A, 1 open data port, 3 Qi coils 4-7/8" x 10-7/8" table top cut out, specify location Note that the wireless unit required a total of 6 ports	6	OPPKIW2P1A1D06MS OPPKIW2P1A1D06MW OPPKIW2P1A1D06MB	6 ft. 6 ft. 6 ft.	MS MW MB	1,110 1,110 1,110	
		OPPKIW2P1A1D10MS OPPKIW2P1A1D10MW OPPKIW2P1A1D10MB	10 ft. 10 ft. 10 ft.	MS MW MB	1,130 1,130 1,130	
<b>Kita II DEEP in surface single-sided unit</b>						
	3 power, 1 dual charging USB-A 4-7/8" x 7-7/8" table top cut out, specify location	4	OPPKID3P1A0D06MS OPPKID3P1A0D06MW OPPKID3P1A0D06MB	6 ft. 6 ft. 6 ft.	MS MW MB	750 750 750
			OPPKID3P1A0D10MS OPPKID3P1A0D10MW OPPKID3P1A0D10MB	10 ft. 10 ft. 10 ft.	MS MW MB	770 770 770
	2 power, 1 USB-A+C, 1 open data 4-7/8" x 7-7/8" table top cut out, specify location	4	OPPKID2PAC1D06MS OPPKID2PAC1D06MW OPPKID2PAC1D06MB	6 ft. 6 ft. 6 ft.	MS MW MB	740 740 740
			OPPKID2PAC1D10MS OPPKID2PAC1D10MW OPPKID2PAC1D10MB	10 ft. 10 ft. 10 ft.	MS MW MB	760 760 760
2 power, 1 dual charging USB-A, 1 open data 4-7/8" x 7-7/8" table top cut out, specify location	4	OPPKID2P1A1D06MS OPPKID2P1A1D06MW OPPKID2P1A1D06MB	6 ft. 6 ft. 6 ft.	MS MW MB	740 740 740	
		OPPKID2P1A1D10MS OPPKID2P1A1D10MW OPPKID2P1A1D10MB	10 ft. 10 ft. 10 ft.	MS MW MB	760 760 760	

Kita II cut out information:

# of ports: 4  
6  
"X" Dim: 7-7/8"W  
10-7/8"W

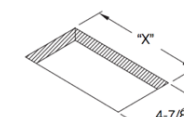







KITA II SERIES FINISH CODE LEGEND:

MS - Matte storm powder coated aluminum with matte storm powder coat simplexes, window frames and end cap, white faceplate, black cord.  
MW - Matte white powder coated aluminum with matte white powder coat simplexes, window frames and end cap, white faceplate, black cord.  
MB - Matte black powder coated aluminum with matte black powder coat simplexes, window frames and end cap, black faceplate, black cord.



# power/data modules

## Kita II back-to-back in surface



module	description	# of ports	model no.	cord length	finish code	list
	Each side contains: 3 power, 1 open data port Total of 6 power, 2 open data ports per unit 9-3/4"D x 7-7/8"W table top cut out	8 (4/side)	OPPK2B6P0A2D06MW OPPK2B6P0A2D06MB	6 ft. 6 ft.	MW MB	1,030 1,030
	Each side contains: 2 power, 1 USB-A+C, 1 open data port Total of 4 power, 2 USB-A+C, 2 open data ports per unit 9-3/4"D x 7-7/8"W table top cut out	8 (4/side)	OPPK2B4P2AC2D06MW OPPK2B4P2AC2D06MB	6 ft. 6 ft.	MW MB	1,260 1,260
	Each side contains: 2 power, 1 dual charging USB-A, 1 open data port Total of 4 power, 2 dual charging USB-A, 2 open data ports 9-3/4"D x 7-7/8"W table top cut out	8 (4/side)	OPPK2B4P2A2D06MW OPPK2B4P2A2D06MB	6 ft. 6 ft.	MW MB	1,260 1,260
	Each side contains: 2 power, 2 open data ports Total of 4 power, 4 open data ports per unit 9-3/4"D x 7-7/8"W table top cut out	8 (4/side)	OPPK2B4P0A4D06MW OPPK2B4P0A4D06MB	6 ft. 6 ft.	MW MB	1,010 1,010
	Side 1 contains: 2 power, 1 USB-A+C, 1 open data Side 2 contains: 2 power 1 USB-A+C, 1 HDMI Total of 4 power 2 USB-A+C, 1 open data, 1 HDMI per unit 9-3/4"D x 7-7/8"W table top cut out	8 (4/side)	OPPK2B4P2AC1D1H06MW OPPK2B4P2AC1D1H06MB	6 ft. 6 ft.	MW MB	1,340 1,340
	Side 1 contains: 2 power, 1 dual charging USB-A, 1 open data Side 2 contains: 2 power, 1 dual charging USB-A, 1 HDMI Total of 4 power 2 dual USB-A, 1 open data, 1 HDMI per unit 9-3/4"D x 7-7/8"W table top cut out	8 (4/side)	OPPK2B4P2A1D1H06MW OPPK2B4P2A1D1H06MB	6 ft. 6 ft.	MW MB	1,340 1,340
	Each side contains: 3 power, 3 open data ports Total of 6 power, 6 open data ports per unit 9-3/4"D x 10-7/8"W table top cut out	12 (6/side)	OPPK2B6P0A6D06MW OPPK2B6P0A6D06MB	6 ft. 6 ft.	MW MB	1,110 1,110
	Each side contains: 3 power, 1 dual charging USB-A, 2 open data ports Total of 6 power, 2 dual charging USB-A, 4 open data ports 9-3/4"D x 10-7/8"W table top cut out	12 (6/side)	OPPK2B6P2A4D06MW OPPK2B6P2A4D06MB	6 ft. 6 ft.	MW MB	1,370 1,370
	Each side contains: 3 power, 1 USB-A+C, 2 open data ports Total of 6 power, 2 USB-A+C, 4 open data ports 9-3/4"D x 10-7/8"W table top cut out	12 (6/side)	OPPK2B6P2A4D06MW OPPK2B6P2A4D06MB	6 ft. 6 ft.	MW MB	1,370 1,370
	Each side contains: 2 power, 1 USB-A+C, 1 dual USB-C 45W, 2 open data ports Total of 4 power, 2 USB-A+C, 2 dual USB-C 45W, 4 open 9-3/4"D x 10-7/8"W table top cut out	12 (6/side)	OPPK2B4P2AC2C4D06MW OPPK2B4P2AC2C4D06MB	6 ft. 6 ft.	MW MB	1,820 1,820
	Side 1 contains: 3 power, 1 dual USB-A, 2 open data Side 2 contains: 3 power, 1 dual USB-A, 1 open data, 1 Total of 6 power, 2 dual charging USB-A, 3 open data, 1 9-3/4"D x 10-7/8"W table top cut out	12 (6/side)	OPPK2B6P2A3D1H06MW OPPK2B6P2A3D1H06MB	6 ft. 6 ft.	MW MB	1,450 1,450
	Side 1 contains: 3 power, 1 USB-A+C, 2 open data Side 2 contains: 3 power 1 USB-A+C, 1 open data, 1 HDMI Total of 6 power, 2 USB-A+C, 3 open data, 1 HDMI 9-3/4"D x 10-7/8"W table top cut out	12 (6/side)	OPPK2B6P2AC3D1H06MW OPPK2B6P2AC3D1H06MB	6 ft. 6 ft.	MW MB	1,450 1,450
	Side 1 contains: 3 power, 1 USB-A+C, 2 open data Side 2 contains: 3 power 1 USB-A+C, 1 open data, 1 HDMI Total of 6 power, 2 USB-A+C, 3 open data, 1 HDMI 9-3/4"D x 10-7/8"W table top cut out	12 (6/side)	OPPK2B6P2AC3D1H06MW OPPK2B6P2AC3D1H06MB	6 ft. 6 ft.	MW MB	1,450 1,450
	Side 1 contains: 3 power, 1 USB-A+C, 2 open data Side 2 contains: 3 power 1 USB-A+C, 1 open data, 1 HDMI Total of 6 power, 2 USB-A+C, 3 open data, 1 HDMI 9-3/4"D x 10-7/8"W table top cut out	12 (6/side)	OPPK2B6P2AC3D1H06MW OPPK2B6P2AC3D1H06MB	6 ft. 6 ft.	MW MB	1,450 1,450

**Kita II Back-To-Back cut out information:**

**KITA II BACK-TO-BACK SERIES FINISH CODE LEGEND:**





# of ports	"X" Dim	Finish	Description
8 (4 ports / side)	7-7/8"W	MW	Matte white powder coated aluminum with matte white simplexes, window frames and end cap, white faceplate, black cord.
12 (6 ports / side)	10-7/8"W	MB	Matte black powder coated aluminum with matte black simplexes, window frames and end cap, black faceplate, black cord.

**Macht Under Surface Mount**

	6 power, black finish, 72" circuit breaker cord slide mount	6	OPPMAC6P0A0D06BK	6 ft.	BK	300
	4 power, 2 open data, black finish, 72" circuit breaker cord, slide mount	6	OPPMAC4P0A2D06BK	6 ft.	BK	280

# power/data modules

## Mio single-sided in surface

module	description	# of ports	model no.	cord length	finish code	list
	1 power, 1 dual charging USB-A 4"D x 5"W table top cut out, specify location	2	OPPMIO1P1A0D06MS OPPMIO1P1A0D06MW OPPMIO1P1A0D06MB OPPMIO1P1A0D06GS	6 ft. 6 ft. 6 ft. 6 ft.	MS MW MB GS	520 520 520 520
	3 power 4"D x 6.5"W table top cut out, specify location	3	OPPMIO3P0A0D06MS OPPMIO3P0A0D06MW OPPMIO3P0A0D06MB OPPMIO3P0A0D06GS	6 ft. 6 ft. 6 ft. 6 ft.	MS MW MB GS	410 410 410 410
	2 power, 1 dual charging USB-A 4"D x 6.5"W table top cut out, specify location	3	OPPMIO2P1A0D06MS OPPMIO2P1A0D06MW OPPMIO2P1A0D06MB OPPMIO2P1A0D06GS	6 ft. 6 ft. 6 ft. 6 ft.	MS MW MB GS	540 540 540 540
	2 power, 1 USB-A+C 4"D x 6.5"W table top cut out, specify location	3	OPPMIO2P1A0D10MS OPPMIO2P1A0D10MW OPPMIO2P1A0D10MB OPPMIO2P1A0D10GS	10 ft. 10 ft. 10 ft. 10 ft.	MS MW MB GS	560 560 560 560
	2 power, 1 USB-A+C 4"D x 6.5"W table top cut out, specify location	3	OPPMIO2PAC0D06MS OPPMIO2PAC0D06MW OPPMIO2PAC0D06MB OPPMIO2PAC0D06GS	6 ft. 6 ft. 6 ft. 6 ft.	MS MW MB GS	540 540 540 540
	3 power, 1 open data 4"D x 8"W table top cut out, specify location	4	OPPMIO3P0A1D06MS OPPMIO3P0A1D06MW OPPMIO3P0A1D06MB OPPMIO3P0A1D06GS	6 ft. 6 ft. 6 ft. 6 ft.	MS MW MB GS	420 420 420 420
	2 power, 1 USB-A+C, 1 open data 4"D x 8"W table top cut out, specify location	4	OPPMIO2PAC1D06MS OPPMIO2PAC1D06MW OPPMIO2PAC1D06MB OPPMIO2PAC1D06GS	6 ft. 6 ft. 6 ft. 6 ft.	MS MW MB GS	550 550 550 550
	2 power, 1 USB-A+C, 1 HDMI 4"D x 8"W table top cut out, specify location	4	OPPMIO2PAC1D10MS OPPMIO2PAC1D10MW OPPMIO2PAC1D10MB OPPMIO2PAC1D10GS	10 ft. 10 ft. 10 ft. 10 ft.	MS MW MB GS	570 570 570 570
	2 power, 1 USB-A+C, 1 HDMI 4"D x 8"W table top cut out, specify location	4	OPPMIO2PAC1H06MS OPPMIO2PAC1H06MW OPPMIO2PAC1H06MB OPPMIO2PAC1H06GS	6 ft. 6 ft. 6 ft. 6 ft.	MS MW MB GS	630 630 630 630
	2 power, 1 USB-A+C, 1 HDMI 4"D x 8"W table top cut out, specify location	4	OPPMIO2PAC1H10MS OPPMIO2PAC1H10MW OPPMIO2PAC1H10MB OPPMIO2PAC1H10GS	10 ft. 10 ft. 10 ft. 10 ft.	MS MW MB GS	650 650 650 650

**Mio single-sided cut out information:**

**MIO SERIES FINISH CODE LEGEND:**

# of ports	"X" Dim	Finish	Description
2	5"	MS	Matte storm powder coated aluminum with storm simplexes, window frames and end cap, black cord.
3	6.5"	MW	Matte white powder coated aluminum with white simplexes, window frames and end cap, black cord.
4	8"	MB	Matte black powder coated aluminum with black simplexes, window frames and end cap, black cord.
		GS	Gloss silver powder coated aluminum with white simplexes, window frames and end cap, white cord.



# power/data modules

Mio back-to-back in surface and Neto clamp mount

module	description	# of ports	model no.	cord length	finish code	list
Mio in surface back-to-back unit	Each side contains: 3 power, 1 open data Total of 6 power, 2 open data per unit	8 (4/side)	OPPMIB6P0A2D06MS	6 ft.	MS	830
			OPPMIB6P0A2D06MW	6 ft.	MW	830
			OPPMIB6P0A2D06MB	6 ft.	MB	830
			OPPMIB6P0A2D10MS	10 ft.	MS	850
	7-11/16"D x 8"L table top cut out, specify		OPPMIB6P0A2D10MW	10 ft.	MW	850
		OPPMIB6P0A2D10MB	10 ft.	MB	850	
	Each side contains: 2 power, 1 USB-A+C, 1 open data Total of 4 power, 2 USB-A+C, 2 open data per unit	8 (4/side)	OPPMIB4P2AC2D06MS	6 ft.	MS	1,080
			OPPMIB4P2AC2D06MW	6 ft.	MW	1,080
			OPPMIB4P2AC2D06MB	6 ft.	MB	1,080
			OPPMIB4P2AC2D10MS	10 ft.	MS	1,100
	7-11/16"D x 8"L table top cut out, specify		OPPMIB4P2AC2D10MW	10 ft.	MW	1,100
		OPPMIB4P2AC2D10MB	10 ft.	MB	1,100	
Each side contains: 2 power, 2 open data Total of 4 power, 2 open data per unit	8 (4/side)	OPPMIB4P0A4D06MS	6 ft.	MS	820	
		OPPMIB4P0A4D06MW	6 ft.	MW	820	
		OPPMIB4P0A4D06MB	6 ft.	MB	820	
		OPPMIB4P0A4D10MS	10 ft.	MS	840	
7-11/16"D x 8"L table top cut out, specify		OPPMIB4P0A4D10MW	10 ft.	MW	840	
	OPPMIB4P0A4D10MB	10 ft.	MB	840		
Each side contains: 2 power, 1 USB-A+C, 1 dual charging USB-A Total of 4 power, 2 USB-A+C, 2 dual USB-A per unit	8 (4/side)	OPPMIB4P2AC2A06MS	6 ft.	MS	1,340	
		OPPMIB4P2AC2A06MW	6 ft.	MW	1,340	
		OPPMIB4P2AC2A06MB	6 ft.	MB	1,340	
		OPPMIB4P2AC2A10MS	10 ft.	MS	1,360	
7-11/16"D x 8"L table top cut out, specify		OPPMIB4P2AC2A10MW	10 ft.	MW	1,360	
	OPPMIB4P2AC2A10MB	10 ft.	MB	1,360		
Each side contains: 2 power, 1 USB-A+C, 1 dual charging USB-C 45w Total of 4 power, 2 USB-A+C, 2 dual USB-C 45w per unit	8 (4/side)	OPPMIB4P2AC2C06MS	6 ft.	MS	1,690	
		OPPMIB4P2AC2C06MW	6 ft.	MW	1,690	
		OPPMIB4P2AC2C06MB	6 ft.	MB	1,690	
		OPPMIB4P2AC2C10MS	10 ft.	MS	1,710	
7-11/16"D x 8"L table top cut out, specify		OPPMIB4P2AC2C10MW	10 ft.	MW	1,710	
	OPPMIB4P2AC2C10MB	10 ft.	MB	1,710		

Mio Back-To-Back cut out information:

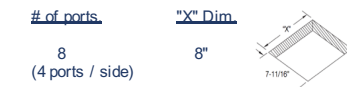

MIO SERIES FINISH CODE LEGEND:

- MS** - Matte storm powder coated aluminum with storm simplexes, window frames and end cap, black cord.
- MW** - Matte white powder coated aluminum with white simplexes, window frames and end cap, black cord.
- MB** - Matte black powder coated aluminum with black simplexes, window frames and end cap, black cord.

Neto edge mount with clamp

Neto edge mount with clamp	1 power, 1 dual charging USB-A	2	OPPNEE1P1A0D06ST	6 ft.	ST	450
			OPPNEE1P1A0D06SW	6 ft.	SW	450
			OPPNEE1P1A0D06SB	6 ft.	SB	450
			OPPNEE1P1A0D10ST	10 ft.	ST	470
		OPPNEE1P1A0D10SW	10 ft.	SW	470	
		OPPNEE1P1A0D10SB	10 ft.	SB	470	
	2 power, 1 dual charging USB-A	3	OPPNEE2P1A0D06ST	6 ft.	ST	470
			OPPNEE2P1A0D06SW	6 ft.	SW	470
			OPPNEE2P1A0D06SB	6 ft.	SB	470
			OPPNEE2P1A0D10ST	10 ft.	ST	490
		OPPNEE2P1A0D10SW	10 ft.	SW	490	
		OPPNEE2P1A0D10SB	10 ft.	SB	490	
2 power, 1 USB-A+C	3	OPPNEE2PAC0D06ST	6 ft.	ST	470	
		OPPNEE2PAC0D06SW	6 ft.	SW	470	
		OPPNEE2PAC0D06SB	6 ft.	SB	470	
		OPPNEE2PAC0D10ST	10 ft.	ST	490	
	OPPNEE2PAC0D10SW	10 ft.	SW	490		
	OPPNEE2PAC0D10SB	10 ft.	SB	490		
2 power, 1 dual USB-C 45w	3	OPPNEE2P0A1C06ST	6 ft.	ST	570	
		OPPNEE2P0A1C06SW	6 ft.	SW	570	
		OPPNEE2P0A1C06SB	6 ft.	SB	570	
		OPPNEE2P0A1C10ST	10 ft.	ST	590	
	OPPNEE2P0A1C10SW	10 ft.	SW	590		
	OPPNEE2P0A1C10SB	10 ft.	SB	590		
3 power	3	OPPNEE3P0A0D06ST	6 ft.	ST	340	
		OPPNEE3P0A0D06SW	6 ft.	SW	340	
		OPPNEE3P0A0D06SB	6 ft.	SB	340	
		OPPNEE3P0A0D10ST	10 ft.	ST	360	
	OPPNEE3P0A0D10SW	10 ft.	SW	360		
	OPPNEE3P0A0D10SB	10 ft.	SB	360		

NETO EDGE MOUNT FINISH CODE LEGEND:

- ST** - Storm molded plastic faceplate and endcaps, Silver anodized aluminum housing and mount, black cord
- SW** - White molded plastic faceplate and endcaps, Silver anodized aluminum housing and mount, white cord
- SB** - Black molded plastic faceplate and endcaps, Silver anodized aluminum housing and mount, black cord

# power/data modules

Neto in surface and under mount

module	description	# of ports	model no.	cord length	finish code	list
Neto in surface	1 power, 1 dual charging USB-A 1-15/16" x 4-13/16" table top cut out, specify	2	OPPNET1P1A0D06ST	6 ft.	ST	450
			OPPNET1P1A0D06SW	6 ft.	SW	450
			OPPNET1P1A0D06SB	6 ft.	SB	450
			OPPNET1P1A0D10ST	10 ft.	ST	470
		OPPNET1P1A0D10SW	10 ft.	SW	470	
		OPPNET1P1A0D10SB	10 ft.	SB	470	
	2 power, 1 dual charging USB-A 1-15/16" x 6-5/16" table top cut out, specify	3	OPPNET2P1A0D06ST	6 ft.	ST	470
			OPPNET2P1A0D06SW	6 ft.	SW	470
			OPPNET2P1A0D06SB	6 ft.	SB	470
			OPPNET2P1A0D10ST	10 ft.	ST	490
		OPPNET2P1A0D10SW	10 ft.	SW	490	
		OPPNET2P1A0D10SB	10 ft.	SB	490	
2 power, 1 USB-A+C 1-15/16" x 6-5/16" table top cut out, specify	3	OPPNET2PAC0D06ST	6 ft.	ST	470	
		OPPNET2PAC0D06SW	6 ft.	SW	470	
		OPPNET2PAC0D06SB	6 ft.	SB	470	
		OPPNET2PAC0D10ST	10 ft.	ST	490	
	OPPNET2PAC0D10SW	10 ft.	SW	490		
	OPPNET2PAC0D10SB	10 ft.	SB	490		
2 power, 1 dual USB-C 45w 1-15/16" x 6-5/16" table top cut out, specify	3	OPPNET2P0A1C06ST	6 ft.	ST	570	
		OPPNET2P0A1C06SW	6 ft.	SW	570	
		OPPNET2P0A1C06SB	6 ft.	SB	570	
		OPPNET2P0A1C10ST	10 ft.	ST	590	
	OPPNET2P0A1C10SW	10 ft.	SW	590		
	OPPNET2P0A1C10SB	10 ft.	SB	590		
1 power, 1 USB-A+C, 1 dual USB-C 45w 1-15/16" x 6-5/16" table top cut out, specify	3	OPPNET1PAC1C06ST	6 ft.	ST	700	
		OPPNET1PAC1C06SW	6 ft.	SW	700	
		OPPNET1PAC1C06SB	6 ft.	SB	700	
		OPPNET1PAC1C10ST	10 ft.	ST	720	
	OPPNET1PAC1C10SW	10 ft.	SW	720		
	OPPNET1PAC1C10SB	10 ft.	SB	720		
3 power 1-15/16" x 6-5/16" table top cut out, specify	3	OPPNET3P0A0D06ST	6 ft.	ST	340	
		OPPNET3P0A0D06SW	6 ft.	SW	340	
		OPPNET3P0A0D06SB	6 ft.	SB	340	
		OPPNET3P0A0D10ST	10 ft.	ST	360	
	OPPNET3P0A0D10SW	10 ft.	SW	360		
	OPPNET3P0A0D10SB	10 ft.	SB	360		

Neto in surface cut out information:



NETO IN SURFACE FINISH CODE LEGEND:

- ST** - Storm molded plastic faceplate and endcaps, Silver anodized aluminum housing, black cord
- SW** - White molded plastic faceplate and endcaps, Silver anodized aluminum housing, black cord
- SB** - Black molded plastic faceplate and endcaps, Silver anodized aluminum housing, black cord

Neto under mount

Neto under mount	2 power, 1 dual charging USB-A 1-15/16" x 6-5/16" table top cut out, specify	3	OPPNUE2P1A0D06ST	6 ft.	ST	470
			OPPNUE2P1A0D06SW	6 ft.	SW	470
			OPPNUE2P1A0D06SB	6 ft.	SB	470
			OPPNUE2P1A0D10ST	10 ft.	ST	490
		OPPNUE2P1A0D10SW	10 ft.	SW	490	
		OPPNUE2P1A0D10SB	10 ft.	SB	490	
	2 power, 1 USB-A+C	3	OPPNUE2PAC0D06ST	6 ft.	ST	470
			OPPNUE2PAC0D06SW	6 ft.	SW	470
			OPPNUE2PAC0D06SB	6 ft.	SB	470
			OPPNUE2PAC0D10ST	10 ft.	ST	490
		OPPNUE2PAC0D10SW	10 ft.	SW	490	
		OPPNUE2PAC0D10SB	10 ft.	SB	490	
2 power, 1 dual USB-C 45w	3	OPPNUE2P0A1C06ST	6 ft.	ST	570	
		OPPNUE2P0A1C06SW	6 ft.	SW	570	
		OPPNUE2P0A1C06SB	6 ft.	SB	570	
		OPPNUE2P0A1C10ST	10 ft.	ST	590	
	OPPNUE2P0A1C10SW	10 ft.	SW	590		
	OPPNUE2P0A1C10SB	10 ft.	SB	590		
3 power	3	OPPNUE2P0A1C06ST	6 ft.	ST	570	
		OPPNUE2P0A1C06SW	6 ft.	SW	570	
		OPPNUE2P0A1C06SB	6 ft.	SB	570	
		OPPNUE2P0A1C10ST	10 ft.	ST	590	
	OPPNUE2P0A1C10SW	10 ft.	SW	590		
	OPPNUE2P0A1C10SB	10 ft.	SB	590		

NETO UNDER MOUNT FINISH CODE LEGEND:

- ST** - Storm molded plastic faceplate and endcaps, Silver anodized aluminum housing, black cord
- SW** - White molded plastic faceplate and endcaps, Silver anodized aluminum housing, white cord
- SB** - Black molded plastic faceplate and endcaps, Silver anodized aluminum housing, black cord

# power/data modules

## Ocho

above surface clamp mount, in surface flush, in surface pop up, under surface

module	description	# of ports	model no.	cord length	finish code	list			
	2 power, 1 dual charging USB-A	3	OPPOCA2P1U06B	6 ft.	B	470			
			OPPOCA2P1U06G	6 ft.	G	470			
			OPPOCA2P1U06S	6 ft.	S	470			
			OPPOCA2P1U06W	6 ft.	W	470			
			OPPOCA2P1U10B	10 ft.	B	490			
			OPPOCA2P1U10G	10 ft.	G	490			
			OPPOCA2P1U10S	10 ft.	S	490			
			OPPOCA2P1U10W	10 ft.	W	490			
				3 power 1 dual charging USB-A, 1 HDMI	5	OPPOCA3PUH06B	6 ft.	B	550
						OPPOCA3PUH06G	6 ft.	G	550
OPPOCA3PUH06S	6 ft.	S				550			
OPPOCA3PUH06W	6 ft.	W				550			
OPPOCA3PUH10B	10 ft.	B				570			
OPPOCA3PUH10G	10 ft.	G				570			
OPPOCA3PUH10S	10 ft.	S				570			
OPPOCA3PUH10W	10 ft.	W				570			
	2 power 1 dual charging USB-A 2.19" x 6" table top cut out, specify location	3				OPPOCF2P1U06B	6 ft.	B	460
						OPPOCF2P1U06G	6 ft.	G	460
			OPPOCF2P1U06S	6 ft.	S	460			
			OPPOCF2P1U06W	6 ft.	W	460			
			OPPOCF2P1U10B	10 ft.	B	480			
			OPPOCF2P1U10G	10 ft.	G	480			
			OPPOCF2P1U10S	10 ft.	S	480			
			OPPOCF2P1U10W	10 ft.	W	480			
				2 power 1 dual charging USB-A 2.19" x 6" table top cut out, specify location	3	OPPOCF2P1U06B	6 ft.	B	460
						OPPOCF2P1U06G	6 ft.	G	460
OPPOCF2P1U06S	6 ft.	S				460			
OPPOCF2P1U06W	6 ft.	W				460			
OPPOCF2P1U10B	10 ft.	B				480			
OPPOCF2P1U10G	10 ft.	G				480			
OPPOCF2P1U10S	10 ft.	S				480			
OPPOCF2P1U10W	10 ft.	W				480			
	3 power 1 dual charging USB-A, 1 HDMI 2.19"D x 8.5"W table top cut out, specify location	5				OPPOCF3PUH06B	6 ft.	B	540
						OPPOCF3PUH06G	6 ft.	G	540
			OPPOCF3PUH06S	6 ft.	S	540			
			OPPOCF3PUH06W	6 ft.	W	540			
			OPPOCF3PUH10B	10 ft.	B	560			
			OPPOCF3PUH10G	10 ft.	G	560			
			OPPOCF3PUH10S	10 ft.	S	560			
			OPPOCF3PUH10W	10 ft.	W	560			
				2 power 1 dual charging USB-A 4.56"D x 6.68"W table top cut out, specify location	3	OPPOCH2P1U06B	6 ft.	B	550
						OPPOCH2P1U06G	6 ft.	G	550
OPPOCH2P1U06S	6 ft.	S				550			
OPPOCH2P1U06W	6 ft.	W				550			
OPPOCH2P1U10B	10 ft.	B				570			
OPPOCH2P1U10G	10 ft.	G				570			
OPPOCH2P1U10S	10 ft.	S				570			
OPPOCH2P1U10W	10 ft.	W				570			
	2 power 1 dual charging USB-A	3				OPPOCU2P1U06B	6 ft.	B	430
						OPPOCU2P1U06G	6 ft.	G	430
			OPPOCU2P1U06S	6 ft.	S	430			
			OPPOCU2P1U06W	6 ft.	W	430			
			OPPOCU2P1U10B	10 ft.	B	450			
			OPPOCU2P1U10G	10 ft.	G	450			
			OPPOCU2P1U10S	10 ft.	S	450			
			OPPOCU2P1U10W	10 ft.	W	450			
				3 power 1 dual charging USB-A, 1 HDMI	5	OPPOCU3PHU06B	6 ft.	B	550
						OPPOCU3PHU06G	6 ft.	G	550
OPPOCU3PHU06S	6 ft.	S				550			
OPPOCU3PHU06W	6 ft.	W				550			
OPPOCU3PHU10B	10 ft.	B				570			
OPPOCU3PHU10G	10 ft.	G				570			
OPPOCU3PHU10S	10 ft.	S				570			
OPPOCU3PHU10W	10 ft.	W				570			

**OCHO SERIES FINISH CODE LEGEND:**

- B - Black plastic face, black metal trim, black cord
- G - Grey plastic face, silver metal trim, black cord
- S - White plastic face, silver metal trim, white cord
- W - White plastic face, white metal trim, white cord

# power/data modules

## Ovi in surface

module	description	model no.	cord length	finish code	list		
	2 power, 1 convenience outlet below the worksurface 2"D x 5.25"W table top cut out size - specify placement	OPPOVI2P0U91SB	9 ft.	SB	430		
		OPPOVI2P0U91BB	9 ft.	BB	430		
		OPPOVI2P0U91GW	9 ft.	GW	430		
		OPPOVI2P0U91AB	9 ft.	AB	530		
		<b>** You can daisy chain up to (4) Ovi units with a 20 amp single circuit outlet</b>					
		2 power, 1 dual charging USB-A, 2 convenience outlets below the worksurface 2"D x 7.25"W table top cut out size - specify placement	OPPOVI2P1U92SB	9 ft.	SB	750	
			OPPOVI2P1U92BB	9 ft.	BB	750	
			OPPOVI2P1U92GW	9 ft.	GW	750	
			OPPOVI2P1U92AB	9 ft.	AB	840	
		<b>** You can daisy chain up to (4) Ovi units with a 20 amp single circuit outlet</b>					
3 power, 1 dual charging USB-A, 1 convenience outlet below the worksurface 2"D x 7.25"W table top cut out size - specify placement	OPPOVI3P1U91SB	9 ft.	SB	720			
	OPPOVI3P1U91BB	9 ft.	BB	720			
	OPPOVI3P1U91GW	9 ft.	GW	720			
	OPPOVI3P1U91AB	9 ft.	AB	840			
<b>** You can daisy chain up to (4) Ovi units with a 20 amp single circuit outlet</b>							
	2 power 2"D x 4.5"W table top cut out size - specify placement	OPPOVI2P0U9SB	9 ft.	SB	410		
		OPPOVI2P0U9BB	9 ft.	BB	410		
		OPPOVI2P0U9GW	9 ft.	GW	410		
		OPPOVI2P0U9AB	9 ft.	AB	480		
		1 power, 1 dual charging USB-A 2"D x 4.5"W table top cut out size - specify placement	OPPOVI1P1U9SB	9 ft.	SB	550	
			OPPOVI1P1U9BB	9 ft.	BB	550	
			OPPOVI1P1U9GW	9 ft.	GW	550	
			OPPOVI1P1U9AB	9 ft.	AB	630	
		2 power, 1 dual charging USB-A 2"D x 5.25"W table top cut out size - specify placement	OPPOVI2P1U9SB	9 ft.	SB	570	
			OPPOVI2P1U9BB	9 ft.	BB	570	
OPPOVI2P1U9GW	9 ft.		GW	570			
OPPOVI2P1U9AB	9 ft.		AB	660			
3 power 2"D x 5.75"W table top cut out size - specify placement	OPPOVI3P0U9SB	9 ft.	SB	610			
	OPPOVI3P0U9BB	9 ft.	BB	610			
	OPPOVI3P0U9GW	9 ft.	GW	610			
	OPPOVI3P0U9AB	9 ft.	AB	720			
3 power, 1 dual charging USB-A 2"D x 7.25"W table top cut out size - specify placement	OPPOVI3P1U9SB	9 ft.	SB	720			
	OPPOVI3P1U9BB	9 ft.	BB	720			
	OPPOVI3P1U9GW	9 ft.	GW	720			
	OPPOVI3P1U9AB	9 ft.	AB	840			
4 power 2"D x 7.25"W table top cut out size - specify placement	OPPOVI4P0U9SB	9 ft.	SB	660			
	OPPOVI4P0U9BB	9 ft.	BB	660			
	OPPOVI4P0U9GW	9 ft.	GW	660			
	OPPOVI4P0U9AB	9 ft.	AB	780			
4 power, 1 dual charging USB-A 2"D x 8.25"W table top cut out size - specify placement	OPPOVI4P1U9SB	9 ft.	SB	750			
	OPPOVI4P1U9BB	9 ft.	BB	750			
	OPPOVI4P1U9GW	9 ft.	GW	750			
	OPPOVI4P1U9AB	9 ft.	AB	870			
6 power 2"D x 10.25"W table top cut out size - specify placement	OPPOVI6P0U9SB	9 ft.	SB	690			
	OPPOVI6P0U9BB	9 ft.	BB	690			
	OPPOVI6P0U9GW	9 ft.	GW	690			
	OPPOVI6P0U9AB	9 ft.	AB	780			
	1 power, 1 dual charging USB-A 2"D x 4.5"W table top cut out size - specify placement	OPPOVR1P1U9SB	9 ft.	SB	550		
		OPPOVR1P1U9BB	9 ft.	BB	550		
		OPPOVR1P1U9GW	9 ft.	GW	550		
		2 power, 1 dual charging USB-A 2"D x 5.25"W table top cut out size - specify placement	OPPOVR2P1U9SB	9 ft.	SB	570	
			OPPOVR2P1U9BB	9 ft.	BB	570	
			OPPOVR2P1U9GW	9 ft.	GW	570	
			2 power 2"D x 4.5"W table top cut out size - specify placement	OPPOVR2P0U9SB	9 ft.	SB	420
		OPPOVR2P0U9BB		9 ft.	BB	420	
		OPPOVR2P0U9GW		9 ft.	GW	420	
		OPPOVR2P0U9AB		9 ft.	AB	420	

**Ovi in surface cut out:**

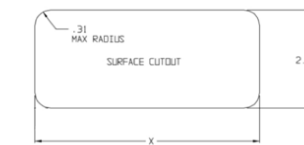

**OVI SERIES FINISH CODE LEGEND:**

- SB - Silver powdercoat finish, black simplex finish
- BB - Black powdercoat finish, black simplex finish
- GW - Gloss white powdercoat finish, white simplex finish
- AB - Brushed aluminum finish, black simplex finish (not available on Ovi Round units)

\* REFERENCE THE CUT OUT SIZE UNDER EACH OVI POWER MODULE FOR THE VALUE OF "X"

# power/data modules

Palla in surface, Pila freestanding, Power Strip



Versie under mount and in surface

# power/data modules

Wayne in surface and Zig freestanding



module	description	model no.	cord length	finish code	list
Palla	3 power 3" diameter table top cut out size, specify location	OPPPAL3P0A0D06SS	6 ft.	SS	230
		OPPPAL3P0A0D06WW	6 ft.	WW	230
		OPPPAL3P0A0D06BB	6 ft.	BB	230
		OPPPAL3P0A0D10SS	10 ft.	SS	250
		OPPPAL3P0A0D10WW	10 ft.	WW	250
		OPPPAL3P0A0D10BB	10 ft.	BB	250
	2 power, 1 dual charging USB-A 3" diameter table top cut out size, specify location	OPPPAL2P1A0D06SS	6 ft.	SS	350
		OPPPAL2P1A0D06WW	6 ft.	WW	350
		OPPPAL2P1A0D06BB	6 ft.	BB	350
		OPPPAL2P1A0D10SS	10 ft.	SS	370
		OPPPAL2P1A0D10WW	10 ft.	WW	370
		OPPPAL2P1A0D10BB	10 ft.	BB	370
2 power, 1 USB-A+C 3" diameter table top cut out size, specify location	OPPPAL2PAC0D06SS	6 ft.	SS	350	
	OPPPAL2PAC0D06WW	6 ft.	WW	350	
	OPPPAL2PAC0D06BB	6 ft.	BB	350	
	OPPPAL2PAC0D10SS	10 ft.	SS	370	
	OPPPAL2PAC0D10WW	10 ft.	WW	370	
	OPPPAL2PAC0D10BB	10 ft.	BB	370	

**PALLA SERIES FINISH CODE LEGEND:**

-  **SS** - Storm case, trim, and simplex finish, black cord
-  **WW** - White case, trim, and simplex finish, white cord
-  **BB** - Black case, trim, and simplex finish, black cord

Pila	4 power, 2 USB-A, 1 USB-C 18W	OPPPIL3P2A1C10SS	10 ft.	SS	1,530
		OPPPIL3P2A1C10WW	10 ft.	WW	1,530
		OPPPIL3P2A1C10BB	10 ft.	BB	1,530

**PILA SERIES FINISH CODE LEGEND:**

-  **SS** - Storm case, trim, and simplex finish, black cord
-  **WW** - White case, trim, and simplex finish, white cord
-  **BB** - Black case, trim, and simplex finish, black cord

Power strip (under mount)	6-outlet, UL tested/listed	OPPSTR6P0D06B	6 ft.	black	120
		OPPSTR6P0D15B	15 ft.	black	200
		OPPSTR6P0D25B	25 ft.	black	250
		OPPSTR6P0D06G	6 ft.	grey	120
		OPPSTR6P0D15G	15 ft.	grey	200
		OPPSTR6P0D25G	25 ft.	grey	250

Versie under mount	2 power	OPPVER2P0A0D06BK	6 ft.	BK	190
		OPPVER2P0A0D10BK	10 ft.	BK	210
	1 power, 1 dual charging USB-A	OPPVER1P1A0D06BK	6 ft.	BK	310
		OPPVER1P1A0D10BK	10 ft.	BK	330
	1 power, 1 USB-A+C	OPPVER1PAC0D06BK	6 ft.	BK	310
		OPPVER1PAC0D10BK	10 ft.	BK	330
1 power, 1 open data	OPPVER1P0A1D06BK	6 ft.	BK	190	
	OPPVER1P0A1D10BK	10 ft.	BK	210	

Versie in surface	2 power 2"D x 3.25"W table top cut out required, specify location	OPPVES2P0A0D06MS	6 ft.	MS	380
		OPPVES2P0A0D06MW	6 ft.	MW	380
		OPPVES2P0A0D06MB	6 ft.	MB	380
		OPPVES2P0A0D10MS	10 ft.	MS	400
		OPPVES2P0A0D10MW	10 ft.	MW	400
		OPPVES2P0A0D10MB	10 ft.	MB	400
	1 power, 1 dual charging USB-A 2"D x 3.25"W table top cut out required, specify location	OPPVES1P1A0D06MS	6 ft.	MS	490
		OPPVES1P1A0D06MW	6 ft.	MW	490
		OPPVES1P1A0D06MB	6 ft.	MB	490
		OPPVES1P1A0D10MS	10 ft.	MS	510
		OPPVES1P1A0D10MW	10 ft.	MW	510
		OPPVES1P1A0D10MB	10 ft.	MB	510
1 power, 1 USB-A+C 2"D x 3.25"W table top cut out required, specify location	OPPVES1PAC0D06MS	6 ft.	MS	490	
	OPPVES1PAC0D06MW	6 ft.	MW	490	
	OPPVES1PAC0D06MB	6 ft.	MB	490	
	OPPVES1PAC0D10MS	10 ft.	MS	510	
	OPPVES1PAC0D10MW	10 ft.	MW	510	
	OPPVES1PAC0D10MB	10 ft.	MB	510	

**VERSIE IN SURFACE SERIES FINISH CODE LEGEND:**

-  **MS** - Matte Storm finish, black cord
-  **MW** - Matte White finish, black cord
-  **MB** - Matte Black finish, black cord

\*\*these finishes are not available for the Versie undermount unit

module	description	model no.	cord length	finish code	list
--------	-------------	-----------	-------------	-------------	------

Wayne Shared Media	4 power, 2 dual charging USB-A 4 HDMI Show Me cables HDMI 4 position switch box 15' HDMI monitor cable, 108" cord. Sliding door grommet included 7.5"D x 12.125"W table top cut out, specify location	OPPWAM4P4H2U9	9 ft.	BB	9,930
		OPPWAM4P4H2U9	9 ft.	SS	9,930
		OPPWAM4P4H2U9	9 ft.	WW	9,930

there is room for (2) telecom data plates in this unit plates are not included in the price but they can be purchased separately



additional adapter accessories available  
email [service@symphonytables.com](mailto:service@symphonytables.com) for assistance.

**WAYNE SHARED MEDIA SERIES FINISH CODE LEGEND:**

-  **BB** - Black grommet finish
-  **SS** - Silver grommet finish
-  **WW** - White grommet finish

Zig freestanding	1 power, 1 dual charging USB-A	OPPZIG1P1A0D09BW	9 ft.	BW	470
		OPPZIG1P1A0D09WB	9 ft.	WB	470
		OPPZIG1P1A0D09BB	9 ft.	BB	470

**ZIG SERIES FINISH CODE LEGEND:**

-  **BW** - Beech wood case, White trim/simplex finish, solid dusk braided cord
-  **WB** - Walnut wood case, Black trim/simplex finish, black and white pinstripe cord
-  **BB** - Black wood case, Black trim/simplex finish, black and white pinstripe cord



# wire management

	description	model no.	list
	<b>Zoey wire management hole</b> the cord will route through the mouse hole and exit at the bottom of the column (1) 1.5" hole at the top / inside of 1 column for a single T or C type base (2) 1.5" holes at the top / inside of each column for a set of (2) T or C type bases (not available for adjustable height bases)	OBTWMH1Z OBTWMH2Z	50 100
	<b>Ria / Keller wire management holes for one single column of a T, C, TT, or 4X base</b> wire management mouse holes (top & bottom) for one base Each hole is a 1.5" x 2.25" oval. Removeable grommets narrow the hole to 1.25" diameter Note that the wire management grommet cannot be made with the polished finish, specify black or white (not available for adj ht bases)	OBTWMH2RG	60
	<b>Ria / Keller wire management cone shaped top plate and WM hole</b> metal cone-shaped top plate conceals and protects center mounted power module in surface Concealed wires exit down inside the base column and out at the bottom of the base column Available for single column Ria and Keller X and Y bases Note that the cone cannot be made with the polished finish black or white paint is available for the cone with a polished base Circo in surface power unit can be used with this cone wire manager (not available for adj ht bases)	OBXWMPCC	350
	<b>Ria / Keller wire management box shaped top plate and WM hole</b> metal box-shaped top plate conceals and protects center mounted power module in surface Concealed wires exit down inside the base column and out at the bottom of the base column Available for single column Ria and Keller X and Y bases Note that the box cannot be made with the polished finish black or white paint is available for the box with a polished base Inside dimensions: 9.5" x 9.5" x 2.75"H, 1.75" access hole in top plate to column (not available for adj ht bases)	OBXWMPBB	470
	<b>Moto Magnetic wire manager for a square or rectangular column</b> standard dimensions: 17 3/4" length, 2" width, 1.06" depth large area for wire management of multiple power and cord sizes easy installation and reposition to any metal surface ** specify metal finish - not available in a polished or wrinkle finish	OBWMMM18	120
	<b>Moto wire management holes for T, C, X, post or frame base</b> 1.25" dia. wire management mouse holes (top & bottom) for one base column (not available for adj ht bases) - 1.5 inch hole available, email service@symphonytables.com for pricing	OBWMMOTO	60
	<b>Novi T type bases wire management holes for one single column</b> Each hole is a 1.5" x 2.25" oval. Removeable grommets narrow the hole to 1.25" diameter Note that the wire management grommet cannot be made with the polished finish, specify black or white (not available for adj ht or polished chrome bases)	OBTWMNOVI	100
	<b>Nantes disc / Marius disc / Moto X / Novi X</b> power box mounting plate with (1) 1.25" mouse hole in the column near the bottom for the cord to exit to a wall or floor outlet away from the base  -Power Box Dimensions 12" x 12", 3" high from top of the column to table top -Power Box Hole Dimensions: 2" dia. on a 3" column, 3 1/2" dia on a 4" column	OBWMPD1H	140
	<b>Nantes / Marius power box mounting plate with wire management hole centered under the disc base</b> wire management hole in the center of a Nantes / Marius disc base for floor access -3" column has a 1 7/8" dia thru hole at bottom / center -4" column has a 2 1/4" dia thru hole at the bottom / center	OBDWMPDHCF	230

\*please note that power supply units and cords vary in size and shape. Please email service@symphonytables.com to ensure that your power supply and cord will work with the table specifications and desired wire management options.

# wire management

	description	model no.	list	
	<b>metal snap on</b> (not available for adjustable ht bases) easy to attach, access, or move metal finish to match base, SPECIFY FINISH (not available in a polished or wrinkle finish) 2" round column version 3" round column version ** Can be used with any base that has a 2" or 3" round column	AWMRM2NB AWMRM3NB	90 100	
	<b>universal wire manager</b> black (B) 26" silver (S) 26" double stick tape is used to adhere the wire manager to the base	OBTWMUPB OBTWMUPS	60 60	
	<b>J channel black nylon wire manager with double stick tape</b> 2.5" x 1" x 71" long 2.5" x 1" x 59" long 2.5" x 1" x 47" long 2.5" x 1" x 35" long 2.5" x 1" x 23" long	AWMJCH72 AWMJCH60 AWMJCH48 AWMJCH36 AWMJCH24	130 120 100 70 50	
	<b>large J channel 72" wire manager with double stick tape</b> Black nylon 3 1/4" x 1" x 71" long additional lengths available	AWMJP72B	250	
	<b>Metal J-style wire manager</b> <b>Standard metal powder coat finishes</b> Flat Black, Furniture White, Inner Tone, Light Tone, Medium Tone, and Metallic Silver	36"W x 4.93"D x 6"H 47"W x 4.93"D x 6"H 59"W x 4.93"D x 6"H 71"W x 4.93"D x 6"H	AWMMJCM36 AWMMJCM47 AWMMJCM59 AWMMJCM71	190 230 250 280
	<b>36" wire management basket</b> sturdy basket made of high quality powder coated steel, black finish 36" long x 5.75"D x 3.5"H exterior dimensions		AWMWB36B 230	
	<b>wire clip set</b> perfect for single power cord or small group of data cords cables easily installed or removed without removing clip .4" wide x 1.156" long with .50" cable bundle diameter natural nylon set of (10) includes (10) wood screws to attach under surface additional sizes available		AWMCL10N 40	
	<b>Spiral wire manager</b> mounted under the worksurface for wire management to the floor, easy to install for use under fixed worksurface up to 30"H	black finish silver finish white finish	AWMVSL-BK AWMVSL-S AWMVSL-W	180 180 180
	<b>Spine wire manager</b> mounted under the worksurface for wire management to the floor, conceals wires inside easy to install, 3 colors available, for fixed or adjustable height tables up to 51"H	black finish silver finish white finish	AWMVSP-BK AWMVSP-S AWMVSP-W	230 230 230

# round grommets

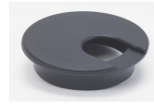

description	model no.	list
nylon 2" diameter, black	OTGRD2NB	60
nylon 2" diameter, white	OTGRD2NW	60
nylon 2" diameter, silver	OTGRD2NS	60



nylon 3" diameter, black	OTGRD3NB	60
nylon 3" diameter, white	OTGRD3NW	60
nylon 3" diameter, silver	OTGRD3NS	60

Specify the grommet location on your PO, note that the above pricing is for a single (1) grommet, if you specify a grommet location that shows (2) grommets then you will need to include 2 grommets per table on your PO. Email [service@symphonytables.com](mailto:service@symphonytables.com) for assistance.

## GROMMET LOCATIONS

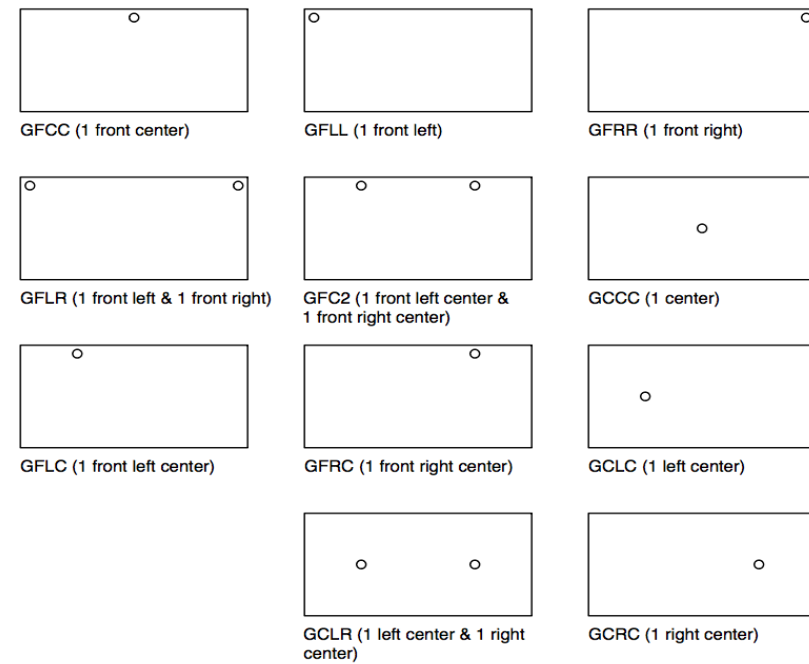

# rectangular grommets



Asti metal 3.39" x 5.68" grommet with flush hinged door	list
flush hinged door, black finish	OTGRADMB 150
flush hinged door, silver finish	OTGRADMS 150
flush hinged door, white finish	OTGRADMW 150
flush hinged door, Brushed Aluminum finish	OTGRADBA 240
flushhinged door, Stainless Steel finish	OTGRADSS 240

3" x 5.25" cut out required

Specify the grommet location on your PO, note that the above pricing is for a single (1) grommet, if you specify a grommet location that shows (2) grommets then you will need to include 2 grommets per table on your PO. Email [service@symphonytables.com](mailto:service@symphonytables.com) for assistance.

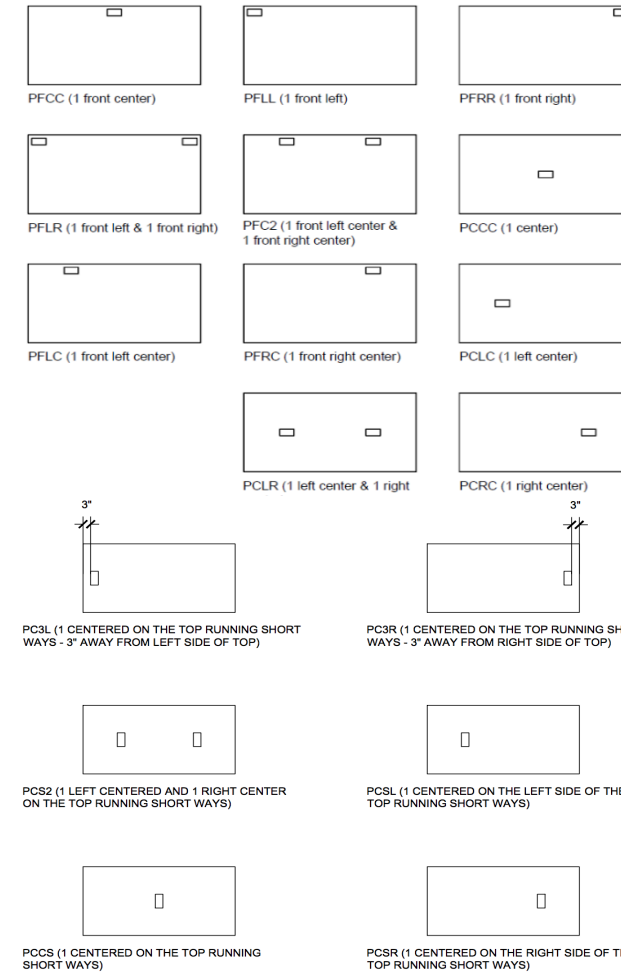

# modesty panels

## fixed

material	description	width	model no.	list
laminite fixed (LX)	<b>8" high fixed laminate modesty panel</b> Select laminate and edge color 3/8" thick particle board laminated with 0.050" thick plastic available with PVC or laminate edge Attaches with "L" bracket fixed hardware	35.5	OMLX836	240
		41.5	OMLX842	250
		47.5	OMLX848	260
		53.5	OMLX854	330
		59.5	OMLX860	340
		65.5	OMLX866	400
	<b>* Contact customer service to ensure that any power or accessories you plan to specify will work with this modesty panel and your base selection, email service@symphonytables.com</b>	71.5	OMLX872	410
laminite fixed modesty wire channel	60" x 3" x 3" black 72" x 3" x 3" black attaches to inside of laminate modesty with factory installed double sided tape additional lengths available	59.5	AWMLXWC5	230
		71.5	AWMLXWC6	250
perforated metal fixed (MP)	<b>9" high perforated metal fixed modesty panel</b> Inside metal wire raceway included 20 gauge fabricated steel	35.75	OMMP936	530
		47.75	OMMP948	560
		59.75	OMMP960	630
		71.75	OMMP972	700
	<b>(ME) Standard metal powder coat finishes :</b> Flat Black (FB), Furniture White (FW), Inner Tone (IT), Light Tone (LT), Medium Tone (MT), Metallic Silver (MS).			
	<b>* Contact customer service to ensure that any power or accessories you plan to specify will work with this modesty panel and your base selection,</b>			
solid metal fixed (MS)	<b>9" high solid metal fixed modesty panel</b> Inside metal wire raceway included 20 gauge fabricated steel	35.75	OMMS936	510
		47.75	OMMS948	550
		59.75	OMMS960	620
		71.75	OMMS972	650
	<b>(ME) Standard metal powder coat finishes :</b> Flat Black (FB), Furniture White (FW), Inner Tone (IT), Light Tone (LT), Medium Tone (MT), Metallic Silver (MS).			
	<b>* Contact customer service to ensure that any power or accessories you</b>			
acrylic fixed (AX)	<b>8" high acrylic modesty panel</b> 3/8" double sided frosted acrylic panel includes (2) brackets and covers for 48" panels includes (3) brackets and covers for 60" & 72" panels silver (S) or black (B) brackets available	47.5	OMAX948S	560
		59.5	OMAX960S	830
		71.5	OMAX972S	840
		47.5	OMAX948B	560
	<b>* Contact customer service to ensure that any power or accessories you plan to specify will work with this modesty panel and your base selection, email service@symphonytables.com</b>	59.5	OMAX960B	720
		71.5	OMAX972B	840

We recommend using tops with 90 degree corners to allow the modesty to be flush with the front (PVEA and UPER for example). Vinyl edge tops have radiused corners so modesty must be positioned back from the front edge.

# modesty panels



## for flip/nest tables

material	description	width	model no.	list
fabric hanging (EH)	<b>10" high fabric hanging modesty panel</b> Black mesh fabric with black liner Additional non-standard widths available up to 72" wide. Steel rod frame Pivot hardware allows modesty to swing & fold for easy storage Hidden wire raceway on inside is secured with multiple Velcro strips.	35.75	OMFH1036	290
		41.75	OMFH1042	300
		47.75	OMFH1048	310
		53.75	OMFH1054	320
		59.75	OMFH1060	330
		65.75	OMFH1066	340
	<b>* Contact customer service to ensure that any power / accessories you plan to specify will work with this modesty panel, email service@symphonytables.com</b>	71.75	OMFH1072	350
laminite hanging (LH)	<b>8" high hanging laminate modesty panel (Do not use with C bases)</b> Select laminate and edge color 3/8" thick particle board laminated with 0.050" thick plastic laminate available with PVC or laminate edge attaches with Nester series hanging modesty panel bracket	35.5	OMLH836	350
		41.5	OMLH842	390
		47.5	OMLH848	410
		53.5	OMLH854	470
		59.5	OMLH860	500
		65.5	OMLH866	550
	<b>**Do not use the laminate hanging modesty panel for Zoey or Keller flip nest tables over 24" deep, 24" deep tops are OK but any other size over 24" could result in the modesty panel hitting the legs when the table is in the nested position.</b>	71.5	OMLH872	570
	<b>* Contact customer service to ensure that any power or accessories you plan to specify will work with this modesty panel and your base selection,</b>			
laminite reverse hinge (RH)	<b>8" high reverse hinge laminate modesty panel</b> for Zoey / Keller over 24" deep or flip nest base table - the modesty panel shall flip "UP" when the table is in the nested position Select laminate and edge color 3/8" thick particle board laminated with 0.050" thick plastic laminate available with PVC or laminate edge attaches with Reverse hinge modesty panel bracket For Zoey or Keller flip nest tables that are over 24" deep or ANY "C" type base flip / nest table so the modesty panel will flip up instead of down	35.5	OMRH836	440
		41.5	OMRH842	480
		47.5	OMRH848	510
		53.5	OMRH854	560
		59.5	OMRH860	580
		65.5	OMRH866	650
	<b>* Contact customer service to ensure that any power or accessories you plan</b>	71.5	OMRH872	680
	<b>* modesty panel will flip "UP"</b>			
perforated metal for flip nest (PH)	<b>9" high perforated metal modesty panel</b> .125 diameter holes on a 2 x 2 inch grid reverse hinge modesty panel bracket	47-7/8	OMPH948	730
		59-7/8	OMPH960	780
		71-7/8	OMPH972	860
			<b>(ME) Standard metal powder coat finishes :</b> Flat Black (FB) or Metallic Silver (MS). **Additional powder coat metal finishes are available on orders with a quantity of 10+ modesty panels in the same size and finish	
	<b>* Contact customer service to ensure that any power or accessories you plan to specify will work with this modesty panel and your base selection, email</b>			
acrylic for flip nest (AH)	<b>8" high acrylic modesty panel</b> 3/8" double sided frosted acrylic panel includes (2) brackets and covers for 48" panels includes (3) brackets and covers for 60" & 72" panels silver (S) or black (B) brackets available	47.5	OMAH948S	590
		59.5	OMAH960S	780
		71.5	OMAH972S	900
		47.5	OMAH948B	590
	<b>* Contact customer service to ensure that any power or accessories you plan to specify will work with this modesty panel and your base selection, email service@symphonytables.com</b>	59.5	OMAH960B	780
		71.5	OMAH972B	900
	<b>* modesty panel will flip "DOWN"</b>			

We recommend using tops with 90 degree corners to allow the modesty to be flush with the front (PVEA and UPER for example). Vinyl edge tops have radiused corners so modesty must be positioned back from the front edge.

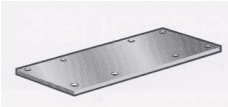

accessories

	description	model no.	list
<b>Table Locks and Plates</b>    	<b>Small Table Lock Set</b> 3" x 6" heavy-duty 11 gauge steel plate set includes 2 plates, 8 knobs (4 per plate), inserts for each seam plates retract and hide away when not in use Black finish	OTL2P8KB	120
	<b>Large Plate Lock</b> 4" x 12" heavy-duty 11 gauge steel plate includes 1 plate, 4 knobs, inserts for each seam one plate attaches tables up to 42" deep plates retract and hide away when not in use Black finish	OTL1P4KB	70
	<b>Clac Table Lock Set</b> twist and lock into place set includes four components (two locks) for each seam and (8) screws zinc finish 3.5" diameter	OTLCLICZ	150
	<b>Fixed Plate Set (set of 50 plates per box)</b> 3" x 6" heavy-duty 1/8" thick steel plates includes 50 plates and wood screws for each seam (no longer sold individually) Black finish	OTL2PWSB50	850

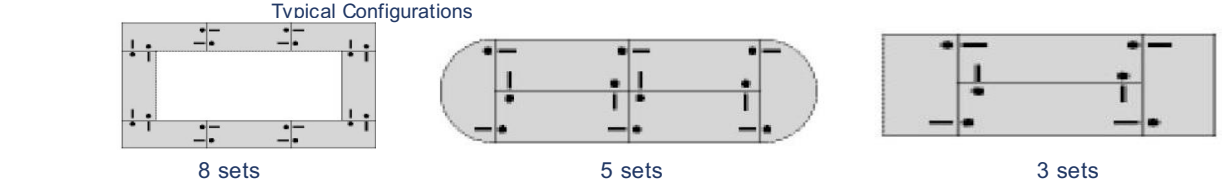

Anti-sag bars



14-gauge rectangular black steel bar mounted under the top  
 all surfaces 54" or longer include top stiffeners with the top pricing

Email [service@symphonytables.com](mailto:service@symphonytables.com) to confirm that the table  
 ganging devices will fit on the top with all other components  
 specified for the table.

# credenzas

For complete credenza model number, insert laminate grade selection:

- M** melamine / low pressure laminate (LPL)
- A** grade A laminate (HPL)
- B** grade B laminate (HPL)
- C** grade C laminate (HPL)

credenza	dimensions	description	model no.	LPL (M)	HPL (A)	HPL (B)	HPL (C)
				list	list	list	list
24 x 36 x 30H	2 door, 1 adj shelves with silver bar pulls	ASCR243630	3,980	4,700	4,930	5,410	
24 x 36 x 36H	2 door, 1 adj shelves with silver bar pulls	ASCR243636	4,130	4,870	5,120	5,630	
24 x 36 x 36H	2 door, 2 drawer, 2 adj shelves with silver bar pulls	ASBC243636	4,470	5,300	5,580	6,140	
24 x 48 x 30H	4 door, 2 adj shelves with silver bar pulls	ASCR244830	4,320	5,140	5,380	5,940	
24 x 48 x 36H	4 door, 2 adj shelves with silver bar pulls	ASCR244836	4,490	5,340	5,600	6,180	
24 x 48 x 36H	4 door, 4 drawer, 2 adj shelves with silver bar pulls	ASBC244836	4,820	5,760	6,050	6,690	
24 x 60 x 30H	4 door, 2 adj shelves with silver bar pulls	ASCR246030	5,260	6,230	6,550	7,190	
24 x 60 x 36H	4 door, 2 adj shelves with silver bar pulls	ASCR246036	5,460	6,480	6,800	7,490	
24 x 60 x 36H	4 door, 4 drawer, 2 adj shelves with silver bar pulls	ASBC246036	5,800	6,910	7,250	8,010	
24 x 72 x 30H	4 door, 2 adj shelves with silver bar pulls	ASCR247230	5,870	6,990	7,330	8,110	
24 x 72 x 36H	4 door, 2 adj shelves with silver bar pulls	ASCR247236	6,090	7,270	7,620	8,450	
24 x 72 x 36H	4 door, 4 drawer, 2 adj shelves with silver bar pulls	ASBC247236	6,550	7,830	8,220	9,120	
24 x 84 x 30H	6 door, 3 adj shelves with silver bar pulls	ASCR248430	7,630	9,140	9,590	10,630	
24 x 84 x 36H	6 door, 3 adj shelves with silver bar pulls	ASCR248436	7,930	9,500	9,980	11,080	
24 x 84 x 36H	6 door, 6 drawer, 3 adj shelves with silver bar pulls	ASBC248436	8,550	10,250	10,780	11,980	
24 x 96 x 30H	6 door, 3 adj shelves with silver bar pulls	ASCR249630	7,690	9,190	9,650	10,680	
24 x 96 x 36H	6 door, 3 adj shelves with silver bar pulls	ASCR249636	7,990	9,550	10,030	11,120	
24 x 96 x 36H	6 door, 6 drawer, 3 adj shelves with silver bar pulls	ASBC249636	8,590	10,320	10,820	12,030	

\* credenzas come with silver lock cores

**STOCK MELAMINE (LPL) COLORS:**

DESIGNER WHITE FROSTY WHITE FASHION GRAY SLATE GRAY BLACK FUSION MAPLE KENSINGTON MAPLE MONTICELLO MAPLE RIVER CHERRY WILD CHERRY BLEACHED LEGNO NEUTRAL TWILL PRESTIGE WALNUT SELECT CHERRY CAFELLE

\* The body of the credenza will be in LPL laminate and the top will be in HPL laminate. LPL laminate is rated for vertical surfaces.

Formica + Wilsonart HPL laminate finish grades listed on page 22-29. For additional laminate grades, contact Symphony

**Credenza options:**

Vent with black vent grills, model number **OACREDVENT**, \$60 list per vent

Grommet for wire management on the back of the credenza, model number **OACREDGROM**, \$40 list per grommet

\* touch latch hardware and soft close hinges are available with an upcharge, contact [service@symphonytables.com](mailto:service@symphonytables.com) for pricing

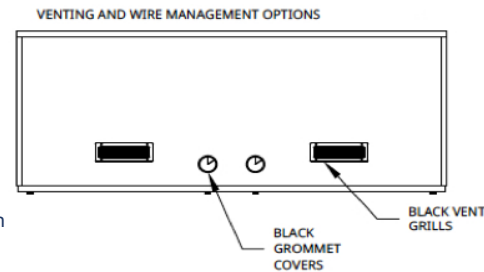

**Credenza standard specifications**

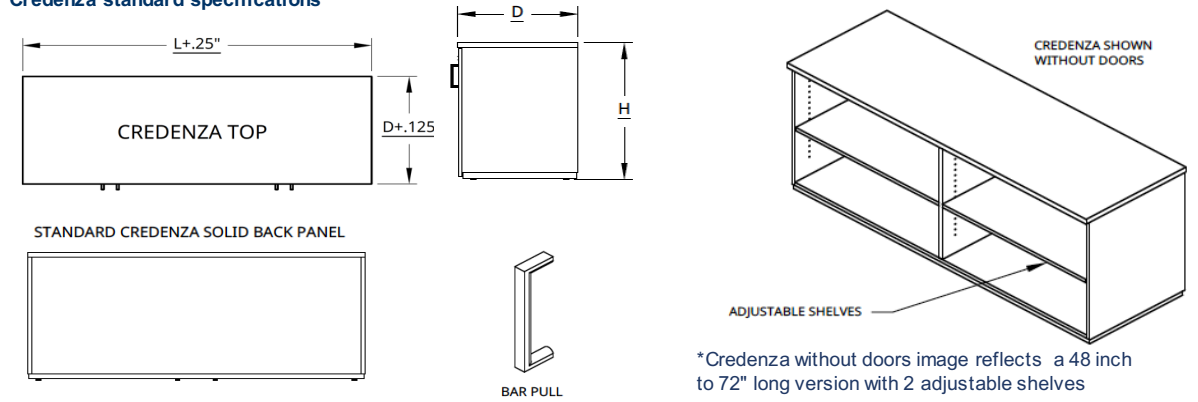

36" L credenza with 2 doors  
\*available in 30"H or 36"H

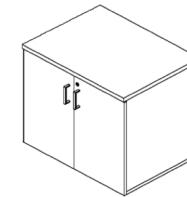

36" L credenza with 2 doors and 2 drawers, 36"H

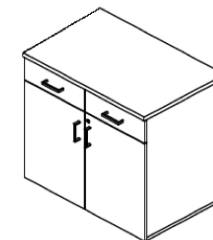

48" - 72" L credenza with 4 doors  
\*available in 30"H or 36"H

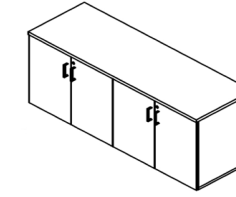

48" - 72"L credenza with 4 doors and 4 drawers, 36"H

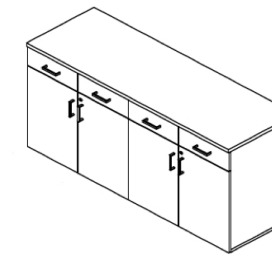

48" - 72" L credenza with 4 doors  
\*available in 30"H or 36"H

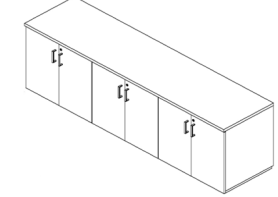

84" - 96"L credenza with 6 doors and 6 drawers, 36"H

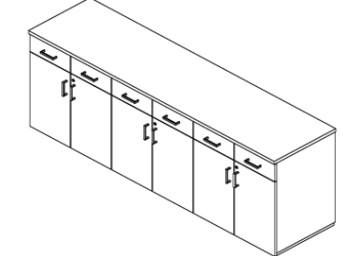

# credenzas

# lectern

# study carrel and screens

For complete lectern model number, insert laminate grade selection:

- M** melamine / low pressure laminate (LPL)
- A** grade A laminate (HPL)
- B** grade B laminate (HPL)
- C** grade C laminate (HPL)

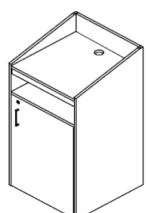
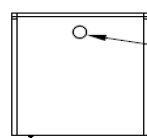
lectern	Description	model no.	LPL (M)	HPL (A)	HPL (B)	HPL (C)
			list	list	list	list
  Grommets in Top, Shelves, and Bottom	laminate lectern flat top surface open shelf two shelves behind locked hinged door wire management holes recessed black locking casters (4) additional sizes, versions, options, configurations available	ALLS4SDC242448__	3,330	4,170	4,370	5,010

**STOCK MELAMINE (LPL) COLORS:**

DESIGNER WHITE FROSTY WHITE FASHION GRAY SLATE GRAY BLACK FUSION MAPLE KENSINGTON MAPLE MONTICELLO  
 MAPLE RIVER CHERRY WILD CHERRY BLEACHED LEGNO NEUTRAL TWILL PRESTIGE WALNUT SELECT CHERRY CAFELLE

Formica + Wilsonart HPL laminate finish grades listed on page 22-29. For additional laminate grades, contact Symphony

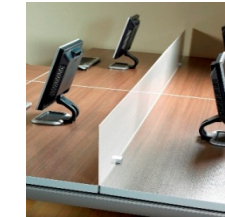

Study carrels, laminate & acrylic screens are available, contact Symphony for pricing and more information



general  
information

## Terms of Sale

All prices listed are delivered pricing to the 48 contiguous states. Orders shipped to Hawaii, Alaska, and Puerto Rico ship to the port of embarkation. Product specifications and pricing is based on the information at time of publication. Symphony reserves the right to make changes at any time without notice regarding product specifications and pricing. Terms are Net 30 from the date of shipment (net 10, 1% discount). Prices are subject to change annually for changes in accordance with state contract regulations. All customer/nonstandard products are subject to a fifty percent (50%) advance deposit. There will be a service charge of 1 1/2% per month on all invoices past due. Symphony reserves the right to use its own or commercial carriers for the "best way" to ship, at its sole discretion.

## Quality Standards

Symphony Furniture products meet or exceed applicable ANSI/BIFMA durability and safety standards when properly installed with appropriate size base.

## Warranty

All Symphony products are guaranteed against defect for a period of ten (10) years. Electrical items and height adjustment mechanisms are guaranteed against defect for a period of five (5) years. Symphony will replace or repair (at our discretion) without cost to our customers any item found to be defective as a result of defective material or workmanship. This excludes any item which has been abused or subjected to any use other than that which was originally intended for our product. Any repairs by our customer must receive specific written authorization from Symphony before work is initiated. This warranty is given to the initial purchaser and is valid for as long as the product is owned by the initial purchaser. The warranty, which runs from the date of manufacture, covers defects in materials and craftsmanship found during normal usage of the products during the warranty period. If a product is defective, and if written notice of the defect is given to Symphony within the warranty period, Symphony at its discretion will either repair or replace the defective product with a comparable component or product, or provide a refund of the purchase price. In no event shall liability under this warranty exceed the original purchase price. Warranty on plastic laminates is not covered by Symphony but is covered by laminate manufacturers under their specific warranty only. There are no other warranties expressed or implied. This warranty does not apply to damage caused by a carrier, alterations to the product not expressly authorized by Symphony. Symphony does not warrant the matching of color, grain, or texture except to within commercially acceptable standards. A product will not be considered defective, and Symphony will not be obligated to replace it, if that product is subject to any of Symphony's written planning, installation or user guides, and is not installed or used as recommended.

Please note that all Losa tables and conference/media tables should not be moved as a complete unit after the product has been assembled. If it is moved, then this could result in the tables being "racked" which could also disrupt the top plate and/or cam lock routing and predrilled holes. This type of damage is not covered under warranty. In order to move a table, you must unassemble the table completely and re-assemble it in the new location.

## Minimum order/Freight Charge

Zone 1 orders less than \$5,000 list (U.S.) - \$200 net

Zone 2 orders less than \$5,000 list (U.S.) - \$260 net

## Sales Policy

Possession of this price list does not constitute authority to purchase and/or sell products contained herein. All orders are subject to acceptance by Symphony Furniture.

## New Accounts

New accounts can only be established with:

Approval of Symphony sales representative

Valid purchase order

State Resale/Exemption Certificate or order will be charged the appropriate sales tax

Application & credit references

Payment in full (initial orders under \$4,000 list) or 50% deposit in advance

## Taxes

Symphony requires a state Resale/Exemption Certificate on file in our main office. Sales made without a certificate will be charged the appropriate sales tax as required by law.

## Freight Terms

Freight charges will be prepaid on all shipments unless special arrangements have been made. Normal delivery is dock to dock. Special requests, such as inside delivery, lift gate service; residential delivery, etc. are subject to additional charges. All accessorial charges not requested on purchase order will be the responsibility of the consignee. Symphony reserves the right to select the "best way" shipment method and means. Delivery date and times are at the discretion of the carrier within reasonable transit time unless special arrangements have been made between the customer and Symphony.

## Acknowledgements

Every order is acknowledged. Orders will be manufactured and invoiced based upon the information on the acknowledgment. If there is any discrepancy, please notify Symphony immediately. Orders are accepted by Symphony per terms on the acknowledgment. All acknowledgements contain an estimated shipping date. Your order may actually ship earlier than the expected shipping date, depending on the backlog at the time. If you do not want the merchandise earlier than the specified date, please write "Do not ship for arrival before \_\_\_\_\_" on your purchase order.

## Revised Orders

Orders requiring changes to the product or additional options will not incur additional costs unless orders have been processed. Orders revised after being manufactured are subject to additional charges.

## Changes or Cancellations

Orders entered and acknowledged cannot be changed or cancelled without Symphony's consent. The customer is responsible for all costs incurred, and a minimum cancellation or change charge of 25% will be invoiced if an order is cancelled or changed within 15 working days of shipment. Orders for nonstandard products are not cancelable.

## Shipments on Hold

Any shipment placed on hold by customer's request or due to balance owed, will be manufactured per the originally scheduled ship date. Storage charges will begin to accrue 7 days from that date. Any order held by our factory over 30 days will be billed and must be promptly paid even though shipment is held at factory at customer's request.

## Special or Additional Freight Charges

Symphony Furniture reserves the right to charge the following when incurring additional freight costs. Destination changes after product has shipped - \$50.00 plus \$2.00/mile after the first 10 miles. Wait time for delivery of greater than two hours - \$130.00/hour. Trailer drop/switch delivery - \$200.00/trailer. Deliveries Friday (after 3:00pm) through Sunday or Holidays - \$600.00/day. Third party to pick up freight at the terminal - \$200.00.

## Redelivery of Freight

When redelivery of merchandise is required because customer is not ready to accept merchandise, and no notification of this fact is given to the factory at least two weeks prior to the scheduled ship date, the actual costs for freight, restocking and re-handling, plus 5% at the order value, will be billed to the customer.

## Receipt of Order

1. Carefully inspect all incoming items
2. If an item is damaged, please note the damage on the delivery receipt.
3. Immediately contact the carrier to request an inspection and their freight claim form.
4. File the freight claim form with the carrier within five days of receipt.
5. If any item is missing or is not correct, please contact Symphony immediately.

Any concealed damages or shortage not reported with 5 business days from delivery shall be the sole responsibility of the customer.

# terms and conditions

## Shipment Damage Claims

Legal title of merchandise passes to the buyer upon acceptance of the carrier. All merchandise is packed to comply with carrier requirements. Shipments should be carefully inspected by the consignee before acceptance and the delivery carrier should be requested to record any damage or shortage. If further damage is found after delivery, immediate inspection by the delivering carrier should be requested. Notification of concealed damages must be made to the delivering carrier within 5 days after delivery of merchandise. Carrier liability ceases after this period. Damaged freight must be kept at the point of delivery in the original packing for inspection by the carrier. Please be advised that if the carrier obtains a clear receipt for shipment, they are no longer responsible for damage or shortages. Please note that electronically signing the carrier's tablet at the time of delivery means that you are accepting the delivery and no damages are being notated. If you see anything that indicates a shipment has been tampered with or shows signs of damage, then ask the driver to report it to the freight company and take pictures.

## Shipment Shortage Claims

Shortage claims reported after 10 days beyond shipment date will not be honored.

## Unopened Shipment Damage Claims

Neither Symphony nor the carrier is responsible for concealed damage claims if shipments are left unopened. Notification of concealed damages must be made to the delivering carrier within 5 days after delivery of merchandise. Refusal to accept an order from the carrier does not relieve you of the responsibility for payment, and may incur additional charges.

## Lost Shipments

Symphony issues a bill of lading to consignee on the date of shipment. If shipment is not received within 20 days of shipment date, notify us. Symphony and the carrier do not assume obligation for lost or damaged shipment claims after 6 months of shipping date.

## Title to Merchandise

Title to merchandise shall pass to the buyer upon delivery by Symphony to the carrier. For purposes of risk or loss, all shipments are F.O.B. factory. Buyer acknowledges that once Symphony delivers the goods to the carrier, title to the goods and risk of loss will pass to the buyer. If the goods are damaged by the carrier while in transit, the buyer has the sole obligation of seeking recourse from the carrier.

## Returns

Symphony will not permit return of materials without written consent if materials shipped are as acknowledged. Return shipments when accepted are subject to a re-handling/restocking charge, in accordance with the state contract after the merchandise is received and inspected. All freight or express charges must be prepaid on return shipments; otherwise, they will not be accepted. Damaged materials and all items specially built to order cannot be returned under any conditions.

## Repair and Replacement

Any labor charges for correcting a manufacturing problem must be submitted and approved before correction is undertaken, if the units are under warranty. Labor charges will not be paid if the estimate was not submitted and approved prior to labor being completed.

## Contact Information

Symphony Furniture, 1720 Mars Hill Road, Suite 8-287, Acworth, GA 30101, GA 30318-1732  
Phone: 866.507.7795

# table care and maintenance

## Table Care and Maintenance

### Laminate Surfaces, Vinyl & PVC edges

High-pressure laminate is durable and requires minimal maintenance. To clean the surface, use a damp cloth or sponge and a mild soap or detergent. Rinse with clean, clear water. Wipe the entire surface, moving with the pattern and follow with a clean, dry, soft cloth. When a wood edge exists, follow "Wood Edge and Veneer" instructions.

Difficult "stains" such as coffee or tea can be removed using a mild household cleaner/detergent and a soft bristle brush, repeating as necessary. If stain persists, use a paste of baking soda & water and apply with a soft bristled brush. Light scrubbing for 10-20 strokes should remove most stains (excessive scrubbing or exerting too much force may damage the surface, especially gloss finish surfaces). Any remaining stains may require the use of undiluted household bleach or nail polish remover. Apply to stain and let stand no longer than two minutes. Rinse thoroughly with warm water & wipe dry. Step may be repeated. However, prolonged exposure of bleach to surface will cause discoloration.

Abrasive pads, scouring powders or cleansers may permanently dull & scratch the surface making the laminate susceptible to staining. Harsh chemicals such as oven, toilet or drain cleaners will etch & discolor laminates. If spills of these products occur, remove immediately, rinse thoroughly, and wipe dry.

High pressure laminates have high heat resistance, however exposure to temperatures greater than 135 degrees C (275 degrees F) is not recommended. Prolonged exposure to temperatures above 65 degrees C (150 degrees F) may result in separation of the laminate from the substrate. Protect the surface from heat generating appliances by using a trivet or insulating pad.

Do not use sharp objects directly on the laminate surface. A counter saver or chopping block is recommended.

HP laminate have excellent impact resistance. However, heavy objects dropped on the surface may chip or crack the laminate.

### Powder Coated Metal

Clean with a mild soap solution and rinse with clean clear water. Wipe the entire surface and follow with a clean, dry cloth to buff dry.

### Chromed Metal

Clean with a wet cloth or window cleaner. For scuff marks or heavy soiling, apply a non-abrasive automotive chrome polish as directed.

### Mechanical Parts

Clean any lint or debris from the moving parts of the tilt or folding mechanisms. Do not apply any lubricant.



# environmental statement and solutions

## Environmental Statement & Solutions

Everyone at Symphony shares the concern of protecting the environment. We use environmentally friendly materials in our products and processes wherever possible. Environmental awareness is something we strive to incorporate into every aspect of our lives. Recycled/recyclable packing/shipping materials are used whenever possible. All plastic, cardboard, scrap metal (steel, stainless steel, & aluminum), used oil, and wood pallets accumulated from the manufacturing process are recycled. All our marketing materials are printed on recycled/recyclable paper.

Symphony is committed to bringing you the designs & solutions needed for your project but also dedicated to preserving the Earth's natural resources for the future.

### Surface Core or Substrate

Standard particleboard core

100% pre-consumer recycled wood fiber particle board certified by Scientific Certification Systems (SCS).

Particleboard is at least 90% wood fiber by weight.

Forest Stewardship Council (FSC); mixed credit available (optional).

Meets California Air Resources Board (CARB) Regulation 93120.2, Phase 1 emissions limits No Added Urea-Formaldehyde (NAUF) Particleboard (optional)

100% pre-consumer recycled wood fiber particle board certified by Scientific

Certification Systems (SCS) Particleboard is at least 90% wood fiber by weight

Forest Stewardship Council (FSC) Mixed Credit Available (optional)

Meets California Air Resources Board (CARB) Regulation 93120.2, Phase 1 emissions limits

No added urea-formaldehyde (NAUF); SCS certified.

Collaborative for High Performance Schools (CHPS) Section 01350 Compliant

Environmentally Preferable Product (EPP) Certified by the Composite Panel Association

### Surface Material

High Pressure Laminate (HPL)

Wilsonart, Formica, Nevamar and Pionite laminates are GREENGUARD Indoor Air Quality Certified®

Wilsonart, Formica, and Pionite laminates are GREENGUARD for Children and Schools Certified®

### Adhesives

Water based adhesive

Low VOC emissions

Does not contain urea-formaldehyde

### Edge Materials

ABS Plastic edge - 2mm ABS plastic edges are available in an array of standard colors

ABS is a recyclable plastic, unlike PVC material

Chlorine Free Polymer can be incinerated

Ecologically responsible chlorine-free polymer may be recycled or incinerated with general wood waste, reducing the amount going into landfills

Urethane edge

Urethane is comprised of approximately 65% refined vegetable oil by weight.

Vegetable oil is a rapidly renewable, natural material

Extreme durability results in a longer lifespan than surfaces made from other materials.

### Bases

Zoey

57% initial recycled content

99% recyclable

Polished aluminum environmentally friendly alternative to polished chrome Standards collection

Produced with a chemical vs. electrical deposition, and encompasses a chemical reaction to metal (ferrous) material

General

Most bases recyclable

Powder coat much more environmentally friendly alternative than liquid metal finishing (over-spray collections increase utilization to over 95%)



---

# SYMPHONY®

table environments

866-507-7795

fax 888-683-0007

[SERVICE@SYMPHONYTABLES.COM](mailto:SERVICE@SYMPHONYTABLES.COM)

[symphonytables.com](http://symphonytables.com)