

# SYMPHONY®

## POST AND FRAME BASES

### 2023 PRICE LIST

version #082823

#### Minimum order / Freight charge

Orders for \$5,000 or more list (contiguous U.S.): freight and minimum order charges included

Orders less than \$5000 list (contiguous U.S.)

Zone 1 \$200 net



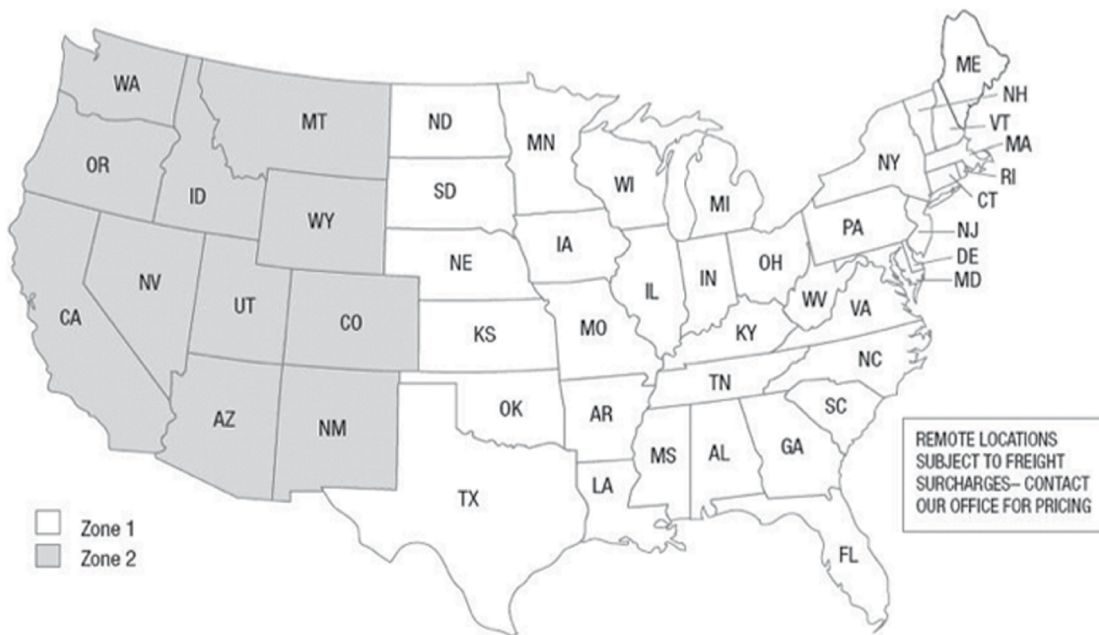

Zone 2 \$260 net



# bases

## Borne & Bati post

### Canty frame

base	max top support	base description	mount plate	qty	model no.	list
<b>Borne base sets (4)</b>						
	48 x 48, 60 rd	2" dia column x 27.75"H, adj glides	4 x 4	4	BPBOR4S02RSDGME	620
	48 x 48	2" dia column cust higher ht, adj glides	4 x 4	4	BPBOR4S02RSHGME	950
	48 x 48, 60 rd	2" dia column cust shorter ht, adj glides	4 x 4	4	BPBOR4S02RSLGME	860
	48 x 48	2" dia column x 27.75"H, 2" black casters	4 x 4	4	BPBOR4S02RSDCME	720
	48 x 48	2" dia column cust higher ht, 2" black casters	4 x 4	4	BPBOR4S02RSHCME	1,050
	48 x 48	2" dia column cust shorter ht, 2" black casters	4 x 4	4	BPBOR4S02RSLCME	950
	48 x 48	2" dia column x 27.75"H, 2" silver/black casters	4 x 4	4	BPBOR4S02RSDPME	760
	48 x 48	2" dia column higher ht, 2" silver/black casters	4 x 4	4	BPBOR4S02RSHPME	1,090
	48 x 48	2" dia column shorter ht, 2" silver/black casters	4 x 4	4	BPBOR4S02RSLPME	1,000
<b>Borne single base (1)</b>						
n/a	2" dia column x 27.75"H, adj glide	4 x 4	1	BPBOR1S02RSDGME	150	
n/a	2" dia column cust higher ht, adj glide	4 x 4	1	BPBOR1S02RSHGME	240	
n/a	2" dia column cust lower ht, adj glide	4 x 4	1	BPBOR1S02RSLGME	210	
	n/a	2" dia column x 27.75"H, 2" black caster	4 x 4	1	BPBOR1S02RSDCME	180
	n/a	2" dia column cust higher ht, 2" black caster	4 x 4	1	BPBOR1S02RSHCME	260
	n/a	2" dia column cust lower ht, 2" black caster	4 x 4	1	BPBOR1S02RSLCME	240
	n/a	2" dia column x 27.75"H, 2" silver/black caster	4 x 4	1	BPBOR1S02RSDPME	190
	n/a	2" dia column cust higher ht, 2" silver/black caster	4 x 4	1	BPBOR1S02RSHPME	280
	n/a	2" dia column cust lower ht, 2" silver/black caster	4 x 4	1	BPBOR1S02RSLPME	250

### Bati single base (1)



*	3" column diameter x 27.75"H	6 x 9	1	BPBAT1S3ODSDBME	500
*	3" column diameter cust higher height	6 x 9	1	BPBAT1S3ODSHBME	630
*	3" column diameter cust shorter height	6 x 9	1	BPBAT1S3ODSLBME	570

\*Bati post legs need to be placed at least every 48". 30" max top depth.

Bati is a surface mounted post base that is bolted to the floor, the base can be centered under the top or offset. The cover for the floor plate is only available in black.

Customer shall supply (4) floor anchors or toggles per base -  
-5/16" anchors required in cement  
-3/8" toggles required in wood

Bati has a 2.5" wire access hole included in the floor plate.  
To specify a 1.25" hole in the column use model number **OBPWMHBAT11 - \$50 list per hole**

### Canty end base set (2)



20 x 72	18 x 1 x 2 x 27.75"H	1" x 2" x 6" tabs	2	BFCAN20072SDGME	860
24 x 72	22 x 1 x 2 x 27.75"H	1" x 2" x 6" tabs	2	BFCAN24072SDGME	900
30 x 72	28 x 1 x 2 x 27.75"H	1" x 2" x 6" tabs	2	BFCAN30072SDGME	980
36 x 72	34 x 1 x 2 x 27.75"H	1" x 2" x 6" tabs	2	BFCAN36072SDGME	1,020
42 x 72	40 x 1 x 2 x 27.75"H	1" x 2" x 6" tabs	2	BFCAN42072SDGME	1,070
48 x 72	46 x 1 x 2 x 27.75"H	1" x 2" x 6" tabs	2	BFCAN48072SDGME	1,120

\*Custom shorter or taller heights are available for Canty bases with a minimum quantity of 20 bases of the same size email [service@symphonytables.com](mailto:service@symphonytables.com) for more information and pricing. Wire management holes not available for the Canty bases.







#### (ME) Standard metal powder coat finishes :

Black Wrinkle (BW), Chateau Brown Wrinkle (CB), Flat Black (FB), Furniture White (FW), Inner Tone (IT), Light Tone (LT), Medium Tone (MT), Metallic Silver (MS)

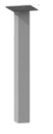
\*Borne and Moto post legs need to be placed every 48"

# bases

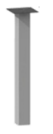
## Moto post

base	max top support	base description	mount plate	qty	model no.	list	
<b>Moto base sets (4)</b>							
	2 x 2 inch	48 x 48, 60 rd	2" sq column x 27.75"H, adj glides	6 x 6	4	BPMOT4S02SSDGME	860
		48 x 48, 60 rd	2" sq column cust higher ht, adj glides	6 x 6	4	BPMOT4S02SSHGME	1,290
		48 x 48, 60 rd	2" sq column cust lower ht, adj glides	6 x 6	4	BPMOT4S02SSLGME	1,090
		48 x 48, 60 rd	2" sq column x 27.75"H, 2" black casters	6 x 6	4	BPMOT4S02SSDCME	950
		48 x 48, 60 rd	2" sq column cust higher ht, 2" black casters	6 x 6	4	BPMOT4S02SSHCME	1,380
		48 x 48, 60 rd	2" sq column x cust lower ht, 2" black casters	6 x 6	4	BPMOT4S02SSLCME	1,190
		48 x 48, 60 rd	2" sq column x 27.75"H, 2" silver/black casters	6 x 6	4	BPMOT4S02SSDPME	1,000
		48 x 48, 60 rd	2" sq column cust higher ht, 2" silver/black casters	6 x 6	4	BPMOT4S02SSHPME	1,430
		48 x 48, 60 rd	2" sq column cust lower ht, 2" silver/black casters	6 x 6	4	BPMOT4S02SSLPME	1,230
<b>Moto single base (1)</b>							
	2 x 2 inch	n/a	2" sq column x 27.75"H, adj glide	6 x 6	1	BPMOT1S02SSDGME	210
		n/a	2" sq column cust higher ht, adj glide	6 x 6	1	BPMOT1S02SSHGME	320
		n/a	2" sq column cust lower ht, adj glide	6 x 6	1	BPMOT1S02SSLGME	280
		n/a	2" sq column x 27.75"H, 2" black caster	6 x 6	1	BPMOT1S02SSDCME	240
		n/a	2" sq column cust higher ht, 2" black caster	6 x 6	1	BPMOT1S02SSHCME	340
		n/a	2" sq column cust lower ht, 2" black caster	6 x 6	1	BPMOT1S02SSLCME	300
		n/a	2" sq column x 27.75"H, 2" silver/black caster	6 x 6	1	BPMOT1S02SSDPME	250
		n/a	2" sq column cust higher ht, 2" silver/black caster	6 x 6	1	BPMOT1S02SSHPME	350
		n/a	2" sq column cust lower ht, 2" silver/black caster	6 x 6	1	BPMOT1S02SSLPME	310
<b>Moto base sets (4)</b>							
	2.75 x 2.75 inch	n/a	2.75" sq column x 27.75"H, adj glide	8 x 8	1	BPMOT1S03SSDGME	250
		n/a	2.75" sq column cust higher ht, adj glide	8 x 8	1	BPMOT1S03SSHGME	390
		n/a	2.75" sq column cust lower ht, adj glide	8 x 8	1	BPMOT1S03SSLGME	310
		n/a	2.75" sq column x 27.75"H, 2" black casters	8 x 8	1	BPMOT1S03SSDCME	280
		n/a	2.75" sq column cust higher ht, 2" black casters	8 x 8	1	BPMOT1S03SSHCME	410
		n/a	2.75" sq column cust lower ht, 2" black casters	8 x 8	1	BPMOT1S03SSLCME	330
		n/a	2.75" sq column x 27.75"H, 2" silver/black casters	8 x 8	1	BPMOT1S03SSDPME	290
		n/a	2.75" sq column cust higher ht, 2" silver/black casters	8 x 8	1	BPMOT1S03SSHPME	420
		n/a	2.75" sq column cust lower ht, 2" silver / black casters	8 x 8	1	BPMOT1S03SSLPME	340

#### Corner mount plate option (Borne & Moto post bases):

Model number **OBPPCM4V** for a set of 4 post bases - **\$180 list per set**  
Model number **OBPPCM1V** for (1) post base - **\$40 list per base**

#### Wire Management hole option (Borne & Moto post bases):

Model number **OBPWMHBOR** for 1.5" dia. wire management holes at the top and bottom of a Borne post base - **\$60 list per base**

bases  
frame  
Moto (glides)

base	outside base dimensions	top size with 1" overhang on each side	base height	model no.	list	glides	finish
Moto Frame Seated Height (27.75"H)	22 x 22	24 x 24	27.75	BFMOT24024SDGME	1,400	adj glides	standard metal
	22 x 34	24 x 36	27.75	BFMOT24036SDGME	1,430	adj glides	standard metal
	22 x 40	24 x 42	27.75	BFMOT24042SDGME	1,440	adj glides	standard metal
	22 x 46	24 x 48	27.75	BFMOT24048SDGME	1,490	adj glides	standard metal
	22 x 58	24 x 60	27.75	BFMOT24060SDGME	1,500	adj glides	standard metal
	22 x 70	24 x 72	27.75	BFMOT24072SDGME	1,540	adj glides	standard metal
	28 x 28	30 x 30	27.75	BFMOT30030SDGME	1,430	adj glides	standard metal
	28 x 34	30 x 36	27.75	BFMOT30036SDGME	1,440	adj glides	standard metal
	28 x 40	30 x 42	27.75	BFMOT30042SDGME	1,450	adj glides	standard metal
	28 x 46	30 x 48	27.75	BFMOT30048SDGME	1,460	adj glides	standard metal
	28 x 58	30 x 60	27.75	BFMOT30060SDGME	1,520	adj glides	standard metal
	28 x 70	30 x 72	27.75	BFMOT30072SDGME	1,550	adj glides	standard metal
	34 x 34	36 x 36	27.75	BFMOT36036SDGME	1,490	adj glides	standard metal
	34 x 40	36 x 42	27.75	BFMOT36042SDGME	1,500	adj glides	standard metal
	34 x 46	36 x 48	27.75	BFMOT36048SDGME	1,510	adj glides	standard metal
	34 x 58	36 x 60	27.75	BFMOT36060SDGME	1,570	adj glides	standard metal
	34 x 70	36 x 72	27.75	BFMOT36072SDGME	1,610	adj glides	standard metal
	40 x 40	42 x 42	27.75	BFMOT42042SDGME	1,510	adj glides	standard metal
40 x 46	42 x 48	27.75	BFMOT42048SDGME	1,520	adj glides	standard metal	
40 x 58	42 x 60	27.75	BFMOT42060SDGME	1,550	adj glides	standard metal	
40 x 70	42 x 72	27.75	BFMOT42072SDGME	1,580	adj glides	standard metal	
46 x 46	48 x 48	27.75	BFMOT48048SDGME	1,530	adj glides	standard metal	
46 x 58	48 x 60	27.75	BFMOT48060SDGME	1,600	adj glides	standard metal	
46 x 70	48 x 72	27.75	BFMOT48060SDGME	1,630	adj glides	standard metal	

Moto Frame Counter Height (34.75"H)	22 x 22	24 x 24	34.75	BFMOT24024SCGME	1,500	adj glides	standard metal
	22 x 34	24 x 36	34.75	BFMOT24036SCGME	1,520	adj glides	standard metal
	22 x 40	24 x 42	34.75	BFMOT24042SCGME	1,530	adj glides	standard metal
	22 x 46	24 x 48	34.75	BFMOT24048SCGME	1,600	adj glides	standard metal
	22 x 58	24 x 60	34.75	BFMOT24060SCGME	1,610	adj glides	standard metal
	22 x 70	24 x 72	34.75	BFMOT24072SCGME	1,640	adj glides	standard metal
	28 x 28	30 x 30	34.75	BFMOT30030SCGME	1,520	adj glides	standard metal
	28 x 34	30 x 36	34.75	BFMOT30036SCGME	1,530	adj glides	standard metal
	28 x 40	30 x 42	34.75	BFMOT30042SCGME	1,540	adj glides	standard metal
	28 x 46	30 x 48	34.75	BFMOT30048SCGME	1,550	adj glides	standard metal
	28 x 58	30 x 60	34.75	BFMOT30060SCGME	1,620	adj glides	standard metal
	28 x 70	30 x 72	34.75	BFMOT30072SCGME	1,650	adj glides	standard metal
	34 x 34	36 x 36	34.75	BFMOT36036SCGME	1,580	adj glides	standard metal
	34 x 40	36 x 42	34.75	BFMOT36042SCGME	1,600	adj glides	standard metal
	34 x 46	36 x 48	34.75	BFMOT36048SCGME	1,610	adj glides	standard metal
	34 x 58	36 x 60	34.75	BFMOT36060SCGME	1,660	adj glides	standard metal
	34 x 70	36 x 72	34.75	BFMOT36072SCGME	1,690	adj glides	standard metal
	40 x 40	42 x 42	34.75	BFMOT42042SCGME	1,610	adj glides	standard metal
40 x 46	42 x 48	34.75	BFMOT42048SCGME	1,620	adj glides	standard metal	
40 x 58	42 x 60	34.75	BFMOT42060SCGME	1,650	adj glides	standard metal	
40 x 70	42 x 72	34.75	BFMOT42072SCGME	1,670	adj glides	standard metal	
46 x 46	48 x 48	34.75	BFMOT48048SCGME	1,630	adj glides	standard metal	
46 x 58	48 x 60	34.75	BFMOT48060SCGME	1,680	adj glides	standard metal	
46 x 70	48 x 72	34.75	BFMOT48060SCGME	1,730	adj glides	standard metal	

bases  
frame  
Moto (glides)

base	outside base dimensions	top size with 1" overhang on each side	base height	model no.	list	glides	finish
Moto Frame Bar Height (40.75"H)	22 x 22	24 x 24	40.75	BFMOT24024SBGME	1,580	adj glides	standard metal
	22 x 34	24 x 36	40.75	BFMOT24036SBGME	1,610	adj glides	standard metal
	22 x 40	24 x 42	40.75	BFMOT24042SBGME	1,630	adj glides	standard metal
	22 x 46	24 x 48	40.75	BFMOT24048SBGME	1,670	adj glides	standard metal
	22 x 58	24 x 60	40.75	BFMOT24060SBGME	1,690	adj glides	standard metal
	22 x 70	24 x 72	40.75	BFMOT24072SBGME	1,730	adj glides	standard metal
	28 x 28	30 x 30	40.75	BFMOT30030SBGME	1,610	adj glides	standard metal
	28 x 34	30 x 36	40.75	BFMOT30036SBGME	1,620	adj glides	standard metal
	28 x 40	30 x 42	40.75	BFMOT30042SBGME	1,630	adj glides	standard metal
	28 x 46	30 x 48	40.75	BFMOT30048SBGME	1,640	adj glides	standard metal
	28 x 58	30 x 60	40.75	BFMOT30060SBGME	1,690	adj glides	standard metal
	28 x 70	30 x 72	40.75	BFMOT30072SBGME	1,740	adj glides	standard metal
	34 x 34	36 x 36	40.75	BFMOT36036SBGME	1,660	adj glides	standard metal
	34 x 40	36 x 42	40.75	BFMOT36042SBGME	1,670	adj glides	standard metal
	34 x 46	36 x 48	40.75	BFMOT36048SBGME	1,680	adj glides	standard metal
	34 x 58	36 x 60	40.75	BFMOT36060SBGME	1,750	adj glides	standard metal
	34 x 70	36 x 72	40.75	BFMOT36072SBGME	1,780	adj glides	standard metal
	40 x 40	42 x 42	40.75	BFMOT42042SBGME	1,680	adj glides	standard metal
40 x 46	42 x 48	40.75	BFMOT42048SBGME	1,690	adj glides	standard metal	
40 x 58	42 x 60	40.75	BFMOT42060SBGME	1,740	adj glides	standard metal	
40 x 70	42 x 72	40.75	BFMOT42072SBGME	1,760	adj glides	standard metal	
46 x 46	48 x 48	40.75	BFMOT48048SBGME	1,720	adj glides	standard metal	
46 x 58	48 x 60	40.75	BFMOT48060SBGME	1,770	adj glides	standard metal	
46 x 70	48 x 72	40.75	BFMOT48060SBGME	1,800	adj glides	standard metal	

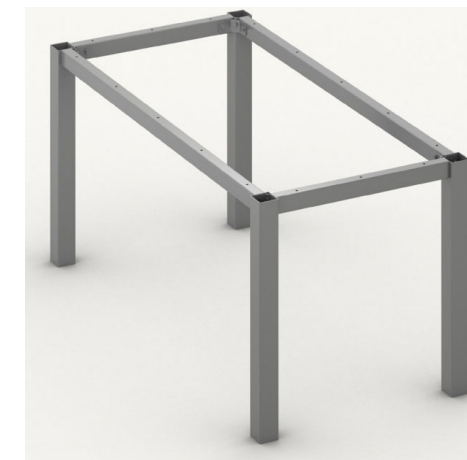

**(ME) Standard metal powder coat finishes :**  
Black Wrinkle (BW), Chateau Brown Wrinkle (CB), Flat Black (FB),  
Furniture White (FW), Inner Tone (IT), Light Tone (LT), Medium Tone (MT), Metallic Silver (MS).

**Wire Management hole option:**  
Model number **OBWWMOTO** for 1.5" dia. wire management holes at the top and bottom of a Moto base - **\$60 list per base**

bases  
frame  
Moto (casters)

base	outside base dimensions	top size with 1" overhang on each side	base height	model no.	list	casters	finish
Moto Frame Seated Height (27.75"H)	22 x 22	24 x 24	27.75	BFMOT24024SDCME	1,640	3.5"H locking	standard metal
	22 x 34	24 x 36	27.75	BFMOT24036SDCME	1,670	3.5"H locking	standard metal
	22 x 40	24 x 42	27.75	BFMOT24042SDCME	1,680	3.5"H locking	standard metal
	22 x 46	24 x 48	27.75	BFMOT24048SDCME	1,730	3.5"H locking	standard metal
	22 x 58	24 x 60	27.75	BFMOT24060SDCME	1,740	3.5"H locking	standard metal
	22 x 70	24 x 72	27.75	BFMOT24072SDCME	1,780	3.5"H locking	standard metal
	28 x 28	30 x 30	27.75	BFMOT30030SDCME	1,670	3.5"H locking	standard metal
	28 x 34	30 x 36	27.75	BFMOT30036SDCME	1,680	3.5"H locking	standard metal
	28 x 40	30 x 42	27.75	BFMOT30042SDCME	1,690	3.5"H locking	standard metal
	28 x 46	30 x 48	27.75	BFMOT30048SDCME	1,710	3.5"H locking	standard metal
	28 x 58	30 x 60	27.75	BFMOT30060SDCME	1,760	3.5"H locking	standard metal
	28 x 70	30 x 72	27.75	BFMOT30072SDCME	1,790	3.5"H locking	standard metal
	34 x 34	36 x 36	27.75	BFMOT36036SDCME	1,730	3.5"H locking	standard metal
	34 x 40	36 x 42	27.75	BFMOT36042SDCME	1,740	3.5"H locking	standard metal
	34 x 46	36 x 48	27.75	BFMOT36048SDCME	1,750	3.5"H locking	standard metal
	34 x 58	36 x 60	27.75	BFMOT36060SDCME	1,820	3.5"H locking	standard metal
	34 x 70	36 x 72	27.75	BFMOT36072SDCME	1,850	3.5"H locking	standard metal
	40 x 40	42 x 42	27.75	BFMOT42042SDCME	1,750	3.5"H locking	standard metal
	40 x 46	42 x 48	27.75	BFMOT42048SDCME	1,760	3.5"H locking	standard metal
	40 x 58	42 x 60	27.75	BFMOT42060SDCME	1,790	3.5"H locking	standard metal
40 x 70	42 x 72	27.75	BFMOT42072SDCME	1,830	3.5"H locking	standard metal	
46 x 46	48 x 48	27.75	BFMOT48048SDCME	1,770	3.5"H locking	standard metal	
46 x 58	48 x 60	27.75	BFMOT48060SDCME	1,840	3.5"H locking	standard metal	
46 x 70	48 x 72	27.75	BFMOT48060SDCME	1,870	3.5"H locking	standard metal	
Moto Frame Counter Height (34.75"H)	22 x 22	24 x 24	34.75	BFMOT24024SCCME	1,740	3.5"H locking	standard metal
	22 x 34	24 x 36	34.75	BFMOT24036SCCME	1,760	3.5"H locking	standard metal
	22 x 40	24 x 42	34.75	BFMOT24042SCCME	1,770	3.5"H locking	standard metal
	22 x 46	24 x 48	34.75	BFMOT24048SCCME	1,840	3.5"H locking	standard metal
	22 x 58	24 x 60	34.75	BFMOT24060SCCME	1,850	3.5"H locking	standard metal
	22 x 70	24 x 72	34.75	BFMOT24072SCCME	1,880	3.5"H locking	standard metal
	28 x 28	30 x 30	34.75	BFMOT30030SCCME	1,760	3.5"H locking	standard metal
	28 x 34	30 x 36	34.75	BFMOT30036SCCME	1,770	3.5"H locking	standard metal
	28 x 40	30 x 42	34.75	BFMOT30042SCCME	1,780	3.5"H locking	standard metal
	28 x 46	30 x 48	34.75	BFMOT30048SCCME	1,790	3.5"H locking	standard metal
	28 x 58	30 x 60	34.75	BFMOT30060SCCME	1,860	3.5"H locking	standard metal
	28 x 70	30 x 72	34.75	BFMOT30072SCCME	1,890	3.5"H locking	standard metal
	34 x 34	36 x 36	34.75	BFMOT36036SCCME	1,830	3.5"H locking	standard metal
	34 x 40	36 x 42	34.75	BFMOT36042SCCME	1,840	3.5"H locking	standard metal
	34 x 46	36 x 48	34.75	BFMOT36048SCCME	1,850	3.5"H locking	standard metal
	34 x 58	36 x 60	34.75	BFMOT36060SCCME	1,900	3.5"H locking	standard metal
	34 x 70	36 x 72	34.75	BFMOT36072SCCME	1,940	3.5"H locking	standard metal
	40 x 40	42 x 42	34.75	BFMOT42042SCCME	1,850	3.5"H locking	standard metal
	40 x 46	42 x 48	34.75	BFMOT42048SCCME	1,860	3.5"H locking	standard metal
	40 x 58	42 x 60	34.75	BFMOT42060SCCME	1,890	3.5"H locking	standard metal
40 x 70	42 x 72	34.75	BFMOT42072SCCME	1,910	3.5"H locking	standard metal	
46 x 46	48 x 48	34.75	BFMOT48048SCCME	1,870	3.5"H locking	standard metal	
46 x 58	48 x 60	34.75	BFMOT48060SCCME	1,930	3.5"H locking	standard metal	
46 x 70	48 x 72	34.75	BFMOT48060SCCME	1,970	3.5"H locking	standard metal	

bases  
frame  
Moto (casters)

base	outside base dimensions	top size with 1" overhang on each side	base height	model no.	list	casters	finish
Moto Frame Bar Height (40.75"H)	22 x 22	24 x 24	40.75	BFMOT24024SBCME	1,830	3.5"H locking	standard metal
	22 x 34	24 x 36	40.75	BFMOT24036SBCME	1,850	3.5"H locking	standard metal
	22 x 40	24 x 42	40.75	BFMOT24042SBCME	1,870	3.5"H locking	standard metal
	22 x 46	24 x 48	40.75	BFMOT24048SBCME	1,910	3.5"H locking	standard metal
	22 x 58	24 x 60	40.75	BFMOT24060SBCME	1,940	3.5"H locking	standard metal
	22 x 70	24 x 72	40.75	BFMOT24072SBCME	1,970	3.5"H locking	standard metal
	28 x 28	30 x 30	40.75	BFMOT30030SBCME	1,850	3.5"H locking	standard metal
	28 x 34	30 x 36	40.75	BFMOT30036SBCME	1,860	3.5"H locking	standard metal
	28 x 40	30 x 42	40.75	BFMOT30042SBCME	1,870	3.5"H locking	standard metal
	28 x 46	30 x 48	40.75	BFMOT30048SBCME	1,880	3.5"H locking	standard metal
	28 x 58	30 x 60	40.75	BFMOT30060SBCME	1,940	3.5"H locking	standard metal
	28 x 70	30 x 72	40.75	BFMOT30072SBCME	1,980	3.5"H locking	standard metal
	34 x 34	36 x 36	40.75	BFMOT36036SBCME	1,900	3.5"H locking	standard metal
	34 x 40	36 x 42	40.75	BFMOT36042SBCME	1,910	3.5"H locking	standard metal
	34 x 46	36 x 48	40.75	BFMOT36048SBCME	1,930	3.5"H locking	standard metal
	34 x 58	36 x 60	40.75	BFMOT36060SBCME	1,990	3.5"H locking	standard metal
	34 x 70	36 x 72	40.75	BFMOT36072SBCME	2,020	3.5"H locking	standard metal
	40 x 40	42 x 42	40.75	BFMOT42042SBCME	1,930	3.5"H locking	standard metal
	40 x 46	42 x 48	40.75	BFMOT42048SBCME	1,940	3.5"H locking	standard metal
	40 x 58	42 x 60	40.75	BFMOT42060SBCME	1,980	3.5"H locking	standard metal
40 x 70	42 x 72	40.75	BFMOT42072SBCME	2,000	3.5"H locking	standard metal	
46 x 46	48 x 48	40.75	BFMOT48048SBCME	1,960	3.5"H locking	standard metal	
46 x 58	48 x 60	40.75	BFMOT48060SBCME	2,010	3.5"H locking	standard metal	
46 x 70	48 x 72	40.75	BFMOT48060SBCME	2,050	3.5"H locking	standard metal	



Pictured with the caster option

\*top not included

**(ME) Standard metal powder coat finishes :**  
Black Wrinkle (BW), Chateau Brown Wrinkle (CB), Flat Black (FB),  
Furniture White (FW), Inner Tone (IT), Light Tone (LT), Medium Tone (MT), Metallic Silver

**Wire Management hole option:**  
Model number **OBWMMOTO** for 1.5" dia. wire management holes at the top and bottom of a Moto base - **\$60 list per base**

# bases

## post

### Krauss

# bases

## post

### Krauss

base	angle	base description	mount plate	Qty	model no.	list for (1) post base
Krauss	22 degrees	2" x 2" x 16.75"H angled column	6 x 6	1	BPKRA12022SOGME	260
	22 degrees	2" x 2" x 27.75"H angled column	6 x 6	1	BPKRA12022SDGME	260
	22 degrees	2.75" x 2.75" x 16.75"H angled column	8 x 8	1	BPKRA13022SOGME	290
	22 degrees	2.75" x 2.75" x 27.75"H angled column	8 x 8	1	BPKRA13022SDGME	290
	30 degrees	2.75" x 2.75" x 27.75"H angled column*	8 x 8	1	BPKRA13030SDGME	290

\*2.75" 30 degree angle base shall be used with 42" or 48" deep rectangle tops

**(ME) Standard metal powder coat finishes :**

Black Wrinkle (BW), Chateau Brown Wrinkle (CB), Flat Black (FB), Furniture White (FW), Inner Tone (IT), Light Tone (LT), Medium Tone (MT), Metallic Silver (MS).

\* The above pricing for the **Krauss series angled post base** is for a single base. Due to the versatility of this base, please email [service@symphonytables.com](mailto:service@symphonytables.com) to verify how many bases you will need and quantity of bases required to support your top.

Note that the height of the base as well as the degree angle of the base will determine the top size that it will support. We encourage you to contact our support team to obtain a drawing to verify that the bases will fit under the intended top size.

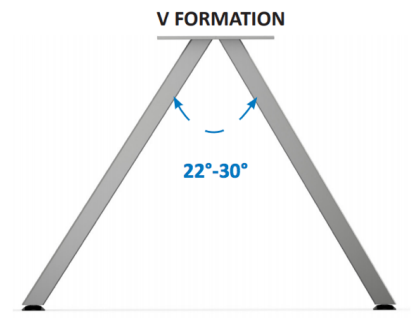

Picture above shows two column legs in V Formation. Multiple variations can be used with this column. Pricing is done per column.



rectangle table with (4) Krauss 2.00 x 2.00 legs



rectangle table with (4) Krauss 2.75 x 2.75 legs

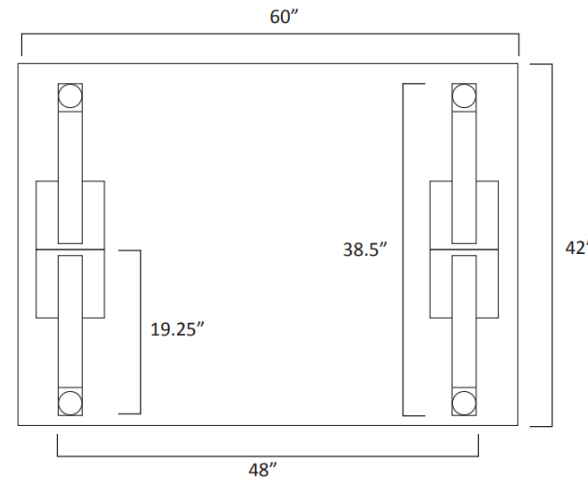

Suggested Max Top size of 42" x 60"

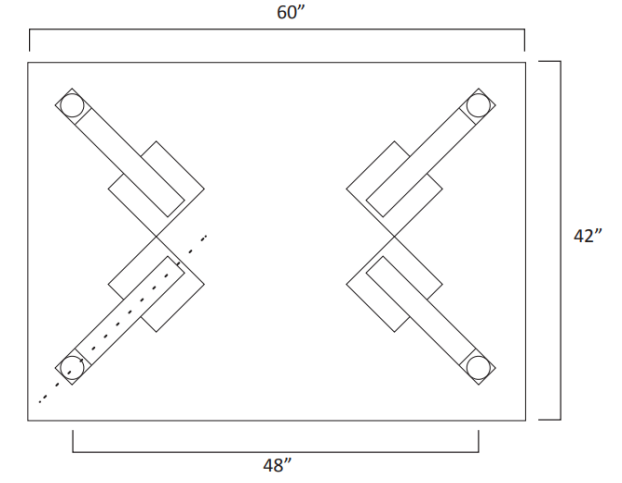

Suggested Max Top size of 42" x 60"

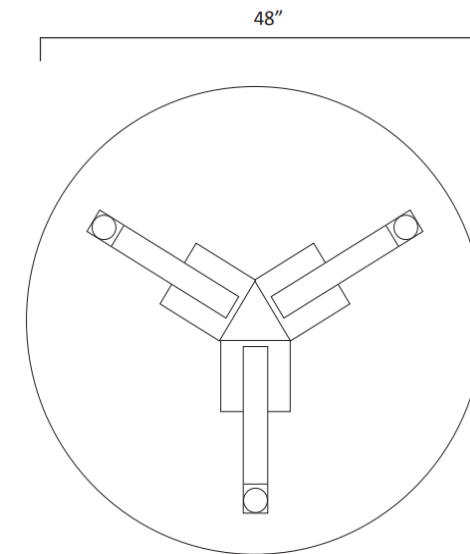

Suggested Max Top size of 48" dia.

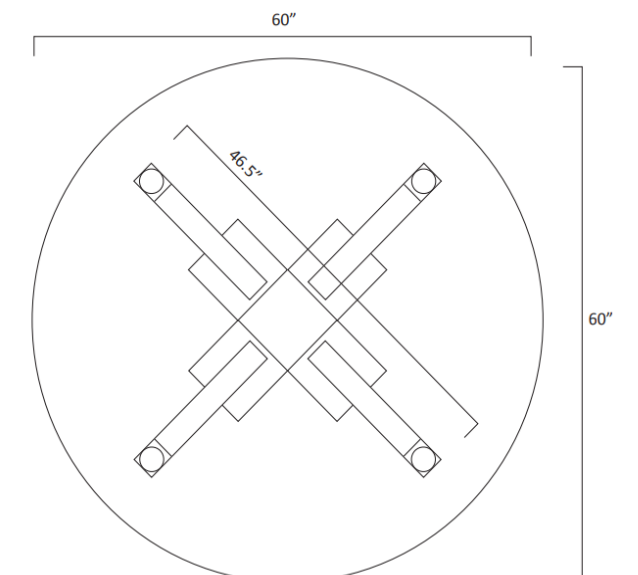

Suggested Max Top size of 60" dia.

# bases

## post Pyra

base	base description	base height	qty	model no.	list
	tapered angled post base with wire management in base, adj glides	27.75	4	BPPYR4STASDGME	840
	tapered angled post base with wire management in base, adj glides	34.75	4	BPPYR4STASCGME	940
	tapered angled post base with wire management in base, adj glides	40.75	4	BPPYR4STASBGME	1,000

reference illustrations to view the minimum and maximum top sizes for each base overall base height (27.75"H, 34.75"H, 40.75"H bases)  
**weight capacity is 200 lbs including the top for a set of 4 bases**

**(ME) Standard metal powder coat finishes :**  
 Flat Black (FB), Furniture White (FW), Inner Tone (IT), Light Tone (LT), Medium Tone (MT), Metallic Silver (MS).

**Note that the maximum table top diameter that 4 bases will hold is 60" round**

ILLUSTRATION A

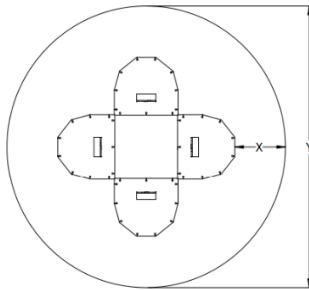

**ROUND TOP CENTER CONFIGURATION**

<b>42" H legs</b> X: 8.75" Y: 48" (minimum table top size)	<b>36" H legs</b> X: 6.8125" Y: 46" (minimum table top size)	<b>29" H legs</b> X: 4.75" Y: 40" (minimum table top size)
--	--	--

ILLUSTRATION B

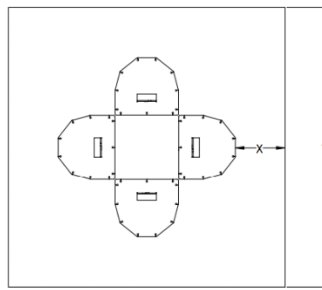

**SQUARE TOP CENTER CONFIGURATION**

<b>42"</b> X: 8.75" Y: 48" (minimum table top size)	<b>36"</b> X: 6.8125" Y: 46" (minimum table top size)	<b>29"</b> X: 4.75" Y: 40" (minimum table top size)
---	---	---



ILLUSTRATION C

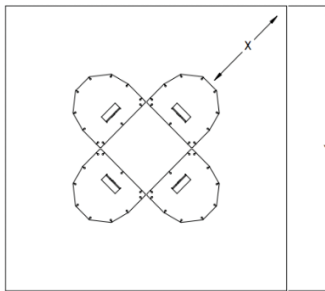

**SQUARE TOP CORNER CONFIGURATION**

<b>42" H legs</b> X: 11.5" Y: 38" (minimum table top size)	<b>36" H legs</b> X: 9.5" Y: 36" (minimum table top size)	<b>29" H legs</b> X: 7.375" Y: 32" (minimum table top size)
--	---	---

Maximum tabletop diameter is 60".

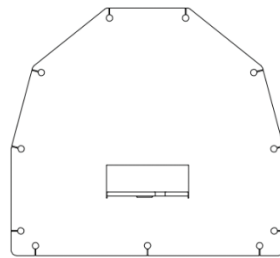

**MOUNTING PLATE**

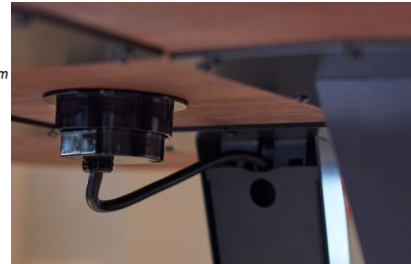

\* top size range: 42 x 42 up to 60 x 60