

# SYMPHONY®

## LOSA

### 2023 PRICE LIST

version #082423

#### Minimum order / Freight charge

Orders for \$5,000 or more list (contiguous U.S.): freight and minimum order charges included

Orders less than \$5000 list (contiguous U.S.)

Zone 1 \$200 net

Zone 2 \$260 net

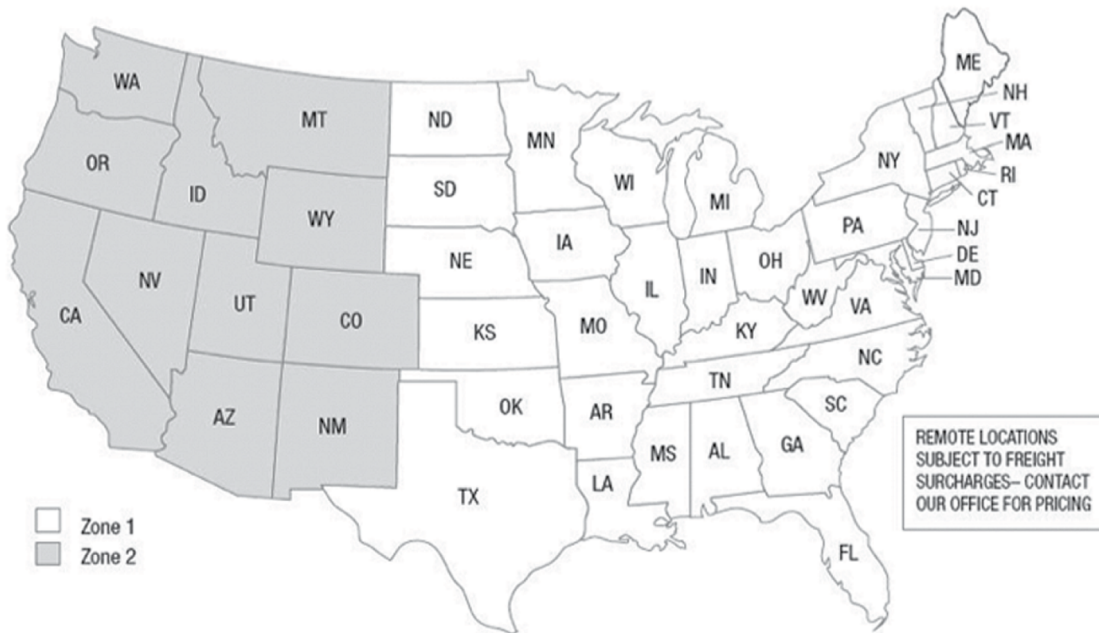

# Losa tables

Wilsonart laminates by number  
+ matching 3mm edges

Lam No	Laminate Name	Laminate Finish Grade		3mm edge	Lam No	Laminate Name	Laminate Finish Grade		3mm edge
		1	2				1	2	
1500	Grey	60		std stock	4846	Morro Zephyr	60		*F
1503	Putty	60		*F	4856	Cloud Zephyr	60		*R
1530	Beige	60		*R	4857	Shadow Zephyr	60		*R
1531	Light Beige	60		*R	4859	Spiced Zephyr	60		*R
1570	White	60		std stock	4860K	Silver Alchemy		7	*R
1572	Antique White	60		std stock	4861K	Gold Alchemy		7	*R
1573	Frosty White	60		std stock	4862	Sandy Topaz		7	*R
1595	Black	60		std stock	4869	Western White	60		*R
1787	Oxide	60		*R	4871	Western Suede	60		*R
2932	Almond Leather	60		*R	4876	Sheer Mesh	38		*R
4142	Grey Glace	60		*R	4877	Grey Mesh	38		std stock
4143	Neutral Glace	60		*R	4878	Pewter Mesh	38		*F
4166	Pampas	60		*R	4879	Steel Mesh	38		*F
4168	Grey Pampas	60		*R	4880	Carbon Mesh	38		*F
4170	Beige Pampas	60		*R	4882	Oiled Soapstone	38		*F
4588	Kalahari Topaz		7	*R	4883	Sable Soapstone	38		
4589K	Smoky Topaz		7	*R	4885	Green Soapstone	38		*R
4621	White Nebula	60		*F	4886	Pearl Soapstone	38		*R
4622	Grey Nebula	60		*F	4887	Tan Soapstone	38		*F
4623	Graphite Nebula	60		std stock	4888	Rustic Sate	38		*R
4630	Cloud Nebula	60		*R	4909	Ginseng Tea	60		
4651	Navy Legacy	60		*R	4911	Soft Gold Mesh	38		*R
4656	Bronze Legacy	60		*R	4912	Gilded Mesh	38		
4663	Tawny Legacy	60		*R	4915	Tangerine	60		*R
4667	Green Tigris	60		*R	4918	Sprout	60		*R
4669	Natural Tigris	60		*R	4939K	Vapor Strandz		18	*R
4674	Evening Tigris	60		*F	4940K	Astro Strandz		18	*R
4745	Maroochy Brush	60			4941K	Cosmic Strandz		18	*F
4746	Woolamai Brush	60			4996	High Rise	38		*R
4779	Pewter Brush	60		*F	7039K	Windsor Mahogany		78	std stock
4783	White Tigris	60		*R	7040K	Figured Mahogany		78	std stock
4794	Windswept Bronze	60		*R	7054	Wild Cherry	60		std stock
4795	Windswept Pewter	60		*R	7061	Natural Pear	60		*F
4796	Burnished Chestnut	60		*R	7110K	Montana Walnut		78	std stock
4810	Titanium EV	60		*R	7122K	Empire Mahogany		7	std stock
4811	Silicon EV	60		*R	7209K	Nepal Teak		78	std stock
4813	Nickel EV	60		*R	7806	Bannister Oak	60		std stock
4814	Tungsten EV	60		*R	7816	Solar Oak	60		std stock
4820	Carbon EV	60		*F	7850	Beigewood	60		std stock
4823	Antique Brush	60		*F	7909	Fusion Maple	60		std stock
4830K	Satin Stainless		18	std stock	7911	Manitoba Maple	60		std stock
4841	Desert Zephyr	60		*F	7919K	Amber Cherry		78	std stock
4842	Canyon Zephyr	60		*R	7921	Tuscan Walnut	38		*F
4843	Misted Zephyr	60		*R	7922	Brighton Walnut		7	std stock
4844	Loden Zephyr	60		*R	7923K	Versailles Anigre		7	*F
4845	Twilight Zephyr	60		*R	7924K	Biltmore Cherry		7	std stock

std stock - flex 3mm PVC edge stocked & available for any size/shape top at standard lead time  
 \*F - Flexible PVEA 3mm PVC edge available for an upcharge and a possible extended lead time depending on top sizes and quantity  
 \*R - Rigid PVEA 3mm PVC edge available for an upcharge and a possible extended lead time depending on top sizes and quantity - note that the rigid form prevents the use of this edge on curved or round tops  
 Please note that edge banding availability is subject to change.  
 Email [service@symphonytables.com](mailto:service@symphonytables.com) to check pricing and lead time prior to ordering for \*F and \*R edge banding.

# Losa tables

Wilsonart laminates by number  
+ matching 3mm edges

Lam No	Laminate Name	Laminate Finish Grade		3mm edge	Lam No	Laminate Name	Laminate Finish Grade		3mm edge
		1	2				1	2	
7925	Monticello Maple	38		std stock	7987	Palisades Oak	38		*R
7928	Castle Oak	38		*F	7988	Hibiscus Cherry	38		
7929	Huntington Maple	38		std stock	7989	Persian Cherry	38		
7933K	Cafelle		7	std stock	7990	Mission Maple	38		*R
7935K	Shaker Cherry		7		7991	Neowalnut	38		*R
7936K	Williamsburg Cherry		7	std stock	7992	Pinnacle Walnut	38		std stock
7937	River Cherry	38		std stock	7993	Florence Walnut	38		*R
7938	New Age Oak	38		*R	7994	Lowell Ash	38		*R
7939K	Blond Echo		18	std stock	7995	Sterling Ash	38		*R
7941K	Tan Echo		18	std stock	7996	Natural Recon	38		*R
7942K	Cocobala		7	std stock	7997	Ebony Recon	38		std stock
7943K	Colombian Walnut		7	std stock	7998K	Low Line		18	
7944K	Madagascar		1		7999K	Field Elm		12	std stock
7945K	Xanadu		18	*R	8200K	White Driftwood		16	
7946	Brazilwood	38		std stock	8201K	Grey Elm		12	std stock
7947K	Rio		18	*R	8204K	Weathered Char		16	*R
7948K	Mambo		7	*F	8205K	Ebony Char		16	
7949K	Asian Night		18	std stock	8206K	Saddle Oak		16	
7951K	Asian Sun		18	*R	8207K	Branded Oak		16	*R
7952K	Asian Sand		18	std stock	8208K	Fawn Cypress		16	*R
7953	Harvest Maple	38		std stock	10734	Limber Maple	60		std stock
7954	Natural Rift	38		*R	10745	Fonthill Pear	60		std stock
7957K	Zanzibar		78	std stock	10776	Kensington Maple	60		std stock
7959K	Hampton Walnut		78	std stock	D12	Regimental Red		18	*R
7960K	Studio Teak		18	std stock	D14	Port	60		*F
7962K	Aloe		18	*R	D25	Atlantis	60		std stock
7964K	Skyline Walnut		12	std stock	D30	Natural Almond	60		std stock
7965K	Walnut Heights		12	std stock	D307	Hollyberry	60		*F
7966K	5th Ave. Elm		12	*R	D315	Platinum	60		std stock
7967K	Park Elm		12	*R	D321	Brittany Blue	60		*F
7968K	Loft Oak		12	*R	D327	Pepperdust	60		std stock
7969K	Warehouse Oak		12		D337	Pebble	60		std stock
7970K	High Line		18	std stock	D354	Designer White	60		std stock
7971K	Uptown Walnut		12	*R	D379	Indigo	60		*R
7972K	Truss Maple		12		D381	Fashion Grey	60		*F
7973K	Old Mill Oak		12	*R	D403	White Sand	60		*R
7975K	Raw Chestnut		12		D417	Lapis Blue	60		*R
7976K	White Cypress		12	*R	D427	Linen	60		std stock
7977K	White Barn		12	*R	D431	Alabaster	60		std stock
7980K	ZebraWood		18	*F	D439	Wallaby	60		std stock
7981K	Landmark Wood		12	*R	D495	Coffee Bean	60		std stock
7982	Buka Bark	38		*R	D50	Khaki Brown	60		std stock
7983	Boardwalk Oak	38		*R	D90	North Sea	60		std stock
7984	Mangalore Mango	38		*R	D91	Slate Grey	60		std stock
7985	Morelia Mango	38		*R	D92	Dove Grey	60		std stock
7986	Pasadena Oak	38		*R	D96	Shadow	60		std stock

Please note: additional laminates and finishes may be available with additional fees and/or extended lead times  
 Contact Symphony for pricing and lead time information: [service@symphonytables.com](mailto:service@symphonytables.com)  
 Laminates and specific finishes may be discontinued by Formica or Wilsonart. For the most up to date information, contact your Formica or Wilsonart representative.

# Losa tables

Wilsonart laminates by name  
+ matching 3mm edges

Laminate Name	Lam No	Laminate Finish Grade			Laminate Name	Lam No	Laminate Finish Grade		
		1	2	3mm edge			1	2	3mm edge
5th Ave. Elm	7966K		12	*R	Fawn Cypress	8208K		16	*R
Alabaster	D431	60		std stock	Field Elm	7999K		12	std stock
Almond Leather	2932	60		*R	Figured Mahogany	7040K		78	std stock
Aloe	7962K		18	*R	Florence Walnut	7993	38		*R
<b>Amber Cherry</b>	<b>7919K</b>		<b>78</b>	<b>std stock</b>	Fonthill Pear	10745	60		std stock
Antique Brush	4823	60		*F	<b>Frosty White</b>	<b>1573</b>	<b>60</b>		<b>std stock</b>
Antique White	1572	60		std stock	<b>Fusion Maple</b>	<b>7909</b>	<b>60</b>		<b>std stock</b>
<b>Asian Night</b>	<b>7949K</b>		<b>18</b>	<b>std stock</b>	Gilded Mesh	4912	38		
Asian Sand	7952K		18	std stock	Ginseng Tea	4909	60		
Asian Sun	7951K		18	*R	Gold Alchemy	4861K		7	*R
Astro Strandz	4940K		18	*R	Graphite Nebula	4623	60		std stock
Atlantis	D25	60		std stock	Green Soapstone	4885	38		*R
Bannister Oak	7806	60		std stock	Green Tigris	4667	60		*R
Beige	1530	60		*R	Grey	1500	60		std stock
Beige Pampas	4170	60		*R	Grey Elm	8201K		12	std stock
Beigewood	7850	60		std stock	Grey Glace	4142	60		*R
Biltmore Cherry	7924K		7	std stock	Grey Mesh	4877	38		std stock
<b>Black</b>	<b>1595</b>	<b>60</b>		<b>std stock</b>	Grey Nebula	4622	60		*F
Blond Echo	7939K		18	std stock	Grey Pampas	4168	60		*R
Boardwalk Oak	7983	38		*R	Hampton Walnut	7959K		78	std stock
Branded Oak	8207K		16	*R	Harvest Maple	7953	38		std stock
Brazilwood	7946	38		std stock	Hibiscus Cherry	7988	38		
Brighton Walnut	7922		7	std stock	High Line	7970K		18	std stock
Brittany Blue	D321	60		*F	High Rise	4996	38		*R
Bronze Legacy	4656	60		*R	Hollyberry	D307	60		*F
Buka Bark	7982	38		*R	Huntington Maple	7929	38		std stock
Burnished Chestnut	4796	60		*R	Indigo	D379	60		*R
<b>Cafelle</b>	<b>7933K</b>		<b>7</b>	<b>std stock</b>	Kalahari Topaz	4588		7	*R
Canyon Zephyr	4842	60		*R	<b>Kensington Maple</b>	<b>10776</b>	<b>60</b>		<b>std stock</b>
Carbon EV	4820	60		*F	<b>Khaki Brown</b>	<b>D50</b>	<b>60</b>		<b>std stock</b>
Carbon Mesh	4880	38		*F	Landmark Wood	7981K		12	*R
Castle Oak	7928	38		*F	Lapis Blue	D417	60		*R
Cloud Nebula	4630	60		*R	Light Beige	1531	60		*R
Cloud Zephyr	4856	60		*R	Limber Maple	10734	60		std stock
Cocobala	7942K		7	std stock	Linen	D427	60		std stock
<b>Coffee Bean</b>	<b>D495</b>	<b>60</b>		<b>std stock</b>	Loden Zephyr	4844	60		*R
<b>Colombian Walnut</b>	<b>7943K</b>		<b>7</b>	<b>std stock</b>	Loft Oak	7968K		12	*R
Cosmic Strandz	4941K		18	*F	Low Line	7998K		18	
Desert Zephyr	4841	60		*F	Lowell Ash	7994	38		*R
<b>Designer White</b>	<b>D354</b>	<b>60</b>		<b>std stock</b>	Madagascar	7944K		1	
Dove Grey	D92	60		std stock	Mambo	7948K		7	*F
Ebony Char	8205K		16		Mangalore Mango	7984	38		*R
Ebony Recon	7997	38		std stock	Manitoba Maple	7911	60		std stock
Empire Mahogany	7122K		7	std stock	Maroochy Brush	4745	60		
Evening Tigris	4674	60		*F	Mission Maple	7990	38		*R
Fashion Grey	D381	60		*F	Misted Zephyr	4843	60		*R

**std stock** - flex 3mm PVC edge stocked & available for any size/shape top at standard lead time  
 \*F - Flexible PVEA 3mm PVC edge available for an upcharge and a possible extended lead time depending on top sizes and quantity  
 \*R - Rigid PVEA 3mm PVC edge available for an upcharge and a possible extended lead time depending on top sizes and quantity - note that the rigid form prevents the use of this edge on curved or round tops  
**Please note that edge banding availability is subject to change.**  
 Email [service@symphonytables.com](mailto:service@symphonytables.com) to check pricing and lead time prior to ordering for \*F and \*R edge banding.

# Losa tables

Wilsonart laminates by name  
+ matching 3mm edges

Laminate Name	Lam No	Laminate Finish Grade			Laminate Name	Lam No	Laminate Finish Grade		
		1	2	3mm edge			1	2	3mm edge
Montana Walnut	7110K		78	std stock	Silicon EV	4811	60		*R
<b>Monticello Maple</b>	<b>7925</b>	<b>38</b>		<b>std stock</b>	Silver Alchemy	4860K		7	*R
Morelia Mango	7985	38		*R	<b>Skyline Walnut</b>	<b>7964K</b>		<b>12</b>	<b>std stock</b>
Morro Zephyr	4846	60		*F	<b>Slate Grey</b>	<b>D91</b>	<b>60</b>		<b>std stock</b>
Natural Almond	D30	60		std stock	Smoky Topaz	4589K		7	*R
Natural Pear	7061	60		*F	Soft Gold Mesh	4911	38		*R
Natural Recon	7996	38		*R	Solar Oak	7816	60		std stock
Natural Rift	7954	38		*R	Spiced Zephyr	4859	60		*R
Natural Tigris	4669	60		*R	Sprout	4918	60		*R
Navy Legacy	4651	60		*R	Steel Mesh	4879	38		*F
Neowalnut	7991	38		*R	Sterling Ash	7995	38		*R
Nepal Teak	7209K		78	std stock	<b>Studio Teak</b>	<b>7960K</b>		<b>18</b>	<b>std stock</b>
Neutral Glace	4143	60		*R	Tan Echo	7941K		18	std stock
New Age Oak	7938	38		*R	Tan Soapstone	4887	38		*F
Nickel EV	4813	60		*R	Tangerine	4915	60		*R
North Sea	D90	60		std stock	Tawny Legacy	4663	60		*R
Oiled Soapstone	4882	38		*F	Titanium EV	4810	60		*R
Old Mill Oak	7973K		12	*R	Truss Maple	7972K		12	
Oxide	1787	60		*R	Tungsten EV	4814	60		*R
Palisades Oak	7987	38		*R	Tuscan Walnut	7921	38		*F
Pampas	4166	60		*R	Twilight Zephyr	4845	60		*R
Park Elm	7967K		12	*R	Uptown Walnut	7971K		12	*R
Pasadena Oak	7986	38		*R	Vapor Strandz	4939K		18	*R
Pearl Soapstone	4886	38		*R	Versailles Anigre	7923K		7	*F
Pebble	D337	60		std stock	Wallaby	D439	60		std stock
Pepperdust	D327	60		std stock	<b>Walnut Heights</b>	<b>7965K</b>		<b>12</b>	<b>std stock</b>
Persian Cherry	7989	38			Warehouse Oak	7969K		12	
Pewter Brush	4779	60		*F	Weathered Char	8204K		16	*R
Pewter Mesh	4878	38		*F	Western Suede	4871	60		*R
Pinnacle Walnut	7992	38		std stock	Western White	4869	60		*R
Platinum	D315	60		std stock	White	1570	60		std stock
Port	D14	60		*F	White Barn	7977K		12	*R
Putty	1503	60		*F	White Cypress	7976K		12	*R
Raw Chestnut	7975K		12		White Driftwood	8200K		16	
Regimental Red	D12	18		*R	White Nebula	4621	60		*F
Rio	7947K		18	*R	White Sand	D403	60		*R
<b>River Cherry</b>	<b>7937</b>	<b>38</b>		<b>std stock</b>	White Tigris	4783	60		*R
Rustic Sate	4888	38		*R	<b>Wild Cherry</b>	<b>7054</b>	<b>60</b>		<b>std stock</b>
Sable Soapstone	4883	38			Williamsburg Cherry	7936K		7	std stock
Saddle Oak	8206K		16		<b>Windsor Mahogany</b>	<b>7039K</b>		<b>78</b>	<b>std stock</b>
Sandy Topaz	4862		7	*R	Windswept Bronze	4794	60		*R
Satin Stainless	4830K		18	std stock	Windswept Pewter	4795	60		*R
<b>Shadow</b>	<b>D96</b>	<b>60</b>		<b>std stock</b>	Woolamai Brush	4746	60		
Shadow Zephyr	4857	60		*R	Xanadu	7945K		18	*R
Shaker Cherry	7935K		7		Zanzibar	7957K		78	std stock
Sheer Mesh	4876	38		*R	ZebraWood	7980K		18	*F

Please note: additional laminates and finishes may be available with additional fees and/or extended lead times  
 Contact Symphony for pricing and lead time information: [service@symphonytables.com](mailto:service@symphonytables.com)  
 Laminates and specific finishes may be discontinued by Formica or Wilsonart. For the most up to date information, contact your Formica or Wilsonart representative.

# Losa tables

Formica laminates by number  
+ matching 3mm edges

Lam No	Laminate Name	Laminate Finish Grade		3mm edge	Lam No	Laminate Name	Laminate Finish Grade		3mm edge
		1	2						
118	Finnish Oak	58		*F	2200	Dark Chocolate	58		*R
204	Butcherblock Maple	58			2297	Terril	58		*R
299	Ebony Oxide	58		*R	2770	Sarum Grey	58		*R
300	Sail White Oxide	58			2962	Clementine	58		
303	Antique White Oxide	58		*R	3202	Otter	58		*R
346	Natural Oak	58		*F	3209	Sol	58		*R
459	Brite White	58		std stock	3453	Parquet Latte	58		
463	Sail White	58		*F	3485	Black Walnut	58		*F
464	Graystone	58		std stock	3505	Storm Solidz	58		*R
503	Stone Grafix	58		std stock	3517	Sand Crystall	58		
507	Folkstone Grafix	58			3526	Travertine	58		
515	Graphite Grafix	58		*F	3687	Autumn Indian Slate	58		*R
692	Folkstone Celesta	58		*R	3690	Basalt Slate	58		*R
756	Natural Maple	58		std stock	3692	Labrador Granite	58		
758	Blossom Cherrywood	58			3696	Shoji Screen	58		
827	White Onyx		***90		3698	Beluga Beige	58		*R
837	Graphite	58		std stock	5281	Dogbone White	58		
839	Stop Red	58		*F	5323	Nocturne	58		
845	Spectrum Red	58		*F	5342	Earth	58		*R
851	Spectrum Blue	58		*F	5349	Fossil	58		*R
858	Pumice	58		std stock	5487	Oiled Walnut	58		*R
863	Myriad Ribbonwood	58		*F	5488	Smoky Brown Pear	58		*F
873	Ebony Ribbonwood	58		*F	5489	Espresso Pear	58		*F
899	Desert Beige	58		*F	5875	Neutral Weft	58		*R
902	Platinum	58		std stock	5880	Earthen Warp	58		*R
909	Black	58		std stock	5881	Chocolate Warp	58		*R
912	Storm	58		std stock	5882	Citadel Warp	58		*R
914	Marine Blue	58		*R	5883	Pecan Woodline	58		*F
918	Neutral White	58		*F	5884	Chestnut Woodline	58		*R
920	Almond	58		std stock	5886	Sorrel Cherry	43, 58		*F
923	Surf	58		*F	5887	Millennium Oak	58		*R
927	Folkstone	58		std stock	5904	Wild Cherry	43, 58		*F
928	Mouse	58		*F	6206	Planked Deluxe Pear	43, 58		*R
929	Oyster Gray	58		*R	6208	Glamour Cherry	43, 58		*F
932	Antique White	58		std stock	6209	Prestige Walnut	43		std stock
933	Mission White	58		*F	6212	Wheat Strand	58		*F
934	Pearl	58		*R	6226	Ivory Kashmir	58		
949	White	58		std stock	6306	Wenge Strand	58		*R
961	Fog	58		std stock	6307	Burnt Strand	58		*R
967	Hunter Green	58			6314	Neo Cloud	58		
969	Navy Blue	58		*R	6366	Paloma Dark Gray	58		*R
1097	Citadel	58		*R	6402	Thermo Walnut	43		*F
1150	Vosges Pear	43		*F	6417	Elemental Oxide	58		
1485	Chrome Yellow	58			6437	Chalked Knotty Ash	58		
1517	Eggplant	58			6440	Smoked Knotty Ash	58		*F
1519	Blackened Bronze	58			6447	Sarum Duotex	58		*R
1520	Infinity	58		*R	6448	Infinity Duotex	58		*R
1994	Fox	58		*R	6449	Charcoal Duotex	58		

std stock - flex 3mm PVC edge stocked & available for any size/shape top at standard lead time  
 \*F - Flexible PVEA 3mm PVC edge available for an upcharge and a possible extended lead time depending on top sizes and quantity  
 \*R - Rigid PVEA 3mm PVC edge available for an upcharge and a possible extended lead time depending on top sizes and quantity - note that the rigid form prevents the use of this edge on curved or round tops  
 Please note that edge banding availability is subject to change.  
 Email [service@symphonytables.com](mailto:service@symphonytables.com) to check pricing and lead time prior to ordering for \*F and \*R edge banding.

# Losa tables

Formica laminates by number  
+ matching 3mm edges

Lam No	Laminate Name	Laminate Finish Grade		3mm edge	Lam No	Laminate Name	Laminate Finish Grade		3mm edge
		1	2						
6473	Folkstone Hex	58			8826	Neutral Twill	58		std stock
6474	Storm Hex	58			8827	Sarum Twill	58		*F
6475	Elemental Blue Steel	58			8828	Earthen Twill	58		*F
6698	Paloma Polar	58		*R	8829	Graphite Twill	58		*F
6729	Paloma Bisque	58		*R	8830	Elemental Concrete	58		
6901	Vibrant Green	58		*R	8831	Elemental Stone	58		*R
6902	Grenadine	58			8839	Ashen Ribbonwood	58		*F
6903	Cassis	58		*R	8841	White Ash		***WR	*F
6907	Amarena	58			8842	Weathered Ash		***WR	*F
6920	Mineral Spa	58		*R	8843	Natural Ash		***WR	
6925	Maple Woodline	58		*R	8844	Aged Ash		***WR	*F
6926	Smoky Walnut Woodline	58		*R	8845	Bleached Legno	58		std stock
6932	Macchiato Walnut	58		*F	8846	Oiled Legno	58		*F
6942	Charcoal Boomerang	58			8848	Blackened Legno	58		std stock
7008	Acajou Mahogany	43, 58		*R	8849	Natural Teak	58		*F
7012	Amber Maple	58		std stock	8858	Just Rose	58		
7014	Colorado Slate	58		*R	8905	Waxed Maple	58		
7018	Navy Grafix	58		*R	8906	Danish Maple	58		*R
7022	Natural Canvas	58			8917	Rolled Steel	58		
7197	Dover White	58		std stock	8918	Blackened Steel	58		
7213	Earth Wash	58		*R	8919	Bronzed Steel	58		
7264	Lime Stone	58			8956	Bubble Science	58		
7265	Sand Stone	58			8957	Bubble Organic	58		
7267	Concrete Stone	58			8958	Bubble Art	58		
7288	Ginger Root Maple	58		*F	9012	Ebony	58		*R
7481	Natural Birch	58		*R	9256	Auburn Maple	58		
7484	Cherry Birch	58		*R	9257	Glow Maple	58		
7494	Carrara Envision	58		*R	9283	Walnut Riftwood		***NG	*F
7708	Flax Gauze	58		*R	9285	White Twill	58		*F
7734	Jamocho Granite	58			9311	Silver Oak Herringbone	58		
7735	Portico Marble	58		*R	9312	Planked Urban Oak	58		*F
7738	Cognac Maple	58		*F	9476	White Ice Granite	43		
7739	Cocoa Maple	58		*F	9480	Salvage Planked Elm	58		
7747	Pencil Wood	58		*R	86992	Hard Rock Maple	58		std stock
7759	Select Cherry	43		std stock					
7812	MDF Solidz	58		*R					
7813	Cardboard Solidz	58		*R					
7897	Spectrum Green	58							
7966	New Burgundy	58							
8751	Mojave	58							
8792	Winter Sky	58		*R					
8793	Green Slate	58							
8794	Enamel	58							
8795	Matrix Blue	58							
8814	Denim Twill	58							
8820	Leaf Green	58		*R					
8821	Just Blue	58		*R					
8824	White Drops	58		*R					

Please note: additional laminates and finishes may be available with additional fees and/or extended lead times  
 Contact Symphony for pricing and lead time information: [service@symphonytables.com](mailto:service@symphonytables.com)  
 Laminates and specific finishes may be discontinued by Formica or Wilsonart. For the most up to date information, contact your Formica or Wilsonart representative.

\*\*\*Note that waste fees may apply for Formica NG, WR or 90 finishes. Please email [service@symphonytables.com](mailto:service@symphonytables.com) for a quote.

# Losa tables

Formica laminates by name  
+ matching 3mm edges

Laminate Name	Lam No	Laminate Finish Grade		3mm edge	Laminate Name	Lam No	Laminate Finish Grade		3mm edge
		1	2				1	2	
Acajou Mahogany	7008	43, 58		*R	Dover White	7197	58		std stock
Aged Ash	8844		***WR	*F	Earth	5342	58		*R
Almond	920	58			Earth Wash	7213	58		*R
Amarena	6907	58			Earthen Twill	8828	58		*F
Amber Maple	7012	58			Earthen Warp	5880	58		*R
Antique White	932	58			Ebony	9012	58		*R
Antique White Oxide	303	58		*R	Ebony Oxide	299	58		*R
Ashen Ribbonwood	8839	58		*F	Ebony Ribbonwood	873	58		*F
Auburn Maple	9256	58			Eggplant	1517	58		
Autumn Indian Slate	3687	58		*R	Elemental Blue Steel	6475	58		
Basalt Slate	3690	58		*R	Elemental Concrete	8830	58		
Beluga Beige	3698	58		*R	Elemental Oxide	6417	58		
Black	909	58		std stock	Elemental Stone	8831	58		*R
Black Walnut	3485	58		*F	Enamel	8794	58		
Blackened Bronze	1519	58			Espresso Pear	5489	58		*F
Blackened Legno	8848	58		std stock	Finnish Oak	118	58		*F
Blackened Steel	8918	58			Flax Gauze	7708	58		*R
Bleached Legno	8845	58		std stock	Fog	961	58		std stock
Blossom Cherrywood	758	58			Folkstone	927	58		std stock
Brite White	459	58		std stock	Folkstone Celesta	692	58		*R
Bronzed Steel	8919	58			Folkstone Grafix	507	58		
Bubble Art	8958	58			Folkstone Hex	6473	58		
Bubble Organic	8957	58			Fossil	5349	58		*R
Bubble Science	8956	58			Fox	1994	58		*R
Burnt Strand	6307	58		*R	Ginger Root Maple	7288	58		*F
Butcherblock Maple	204	58			Glamour Cherry	6208	43, 58		*F
Cardboard Solidz	7813	58		*R	Glow Maple	9257	58		
Carrara Envision	7494	58		*R	Graphite	837	58		std stock
Cassis	6903	58		*R	Graphite Grafix	515	58		*F
Chalked Knotty Ash	6437	58			Graphite Twill	8829	58		*F
Charcoal Boomerang	6942	58			Graystone	464	58		std stock
Charcoal Duotex	6449	58			Green Slate	8793	58		
Cherry Birch	7484	58		*R	Grenadine	6902	58		
Chestnut Woodline	5884	58		*R	Hard Rock Maple	86992	58		std stock
Chocolate Warp	5881	58		*R	Hunter Green	967	58		
Chrome Yellow	1485	58			Infinity	1520	58		*R
Citadel	1097	58		*R	Infinity Duotex	6448	58		*R
Citadel Warp	5882	58		*R	Ivory Kashmir	6226	58		
Clementine	2962	58			Jamocho Granite	7734	58		
Cocoa Maple	7739	58		*F	Just Blue	8821	58		*R
Cognac Maple	7738	58		*F	Just Rose	8858	58		
Colorado Slate	7014	58		*R	Labrador Granite	3692	58		
Concrete Stone	7267	58			Leaf Green	8820	58		*R
Danish Maple	8906	58		*R	Lime Stone	7264	58		
Dark Chocolate	2200	58		*R	Macchiato Walnut	6932	58		*F
Denim Twill	8814	58			Maple Woodline	6925	58		*R
Desert Beige	899	58		*F	Marine Blue	914	58		*R
Dogbone White	5281	58			Matrix Blue	8795	58		

**std stock** - flex 3mm PVC edge stocked & available for any size/shape top at standard lead time  
 \*F - Flexible PVEA 3mm PVC edge available for an upcharge and a possible extended lead time depending on top sizes and quantity  
 \*R - Rigid PVEA 3mm PVC edge available for an upcharge and a possible extended lead time depending on top sizes and quantity - note that the rigid form prevents the use of this edge on curved or round tops  
**Please note that edge banding availability is subject to change.**  
 Email [service@symphonytables.com](mailto:service@symphonytables.com) to check pricing and lead time prior to ordering for \*F and \*R edge banding.

# Losa tables

Formica laminates by name  
+ matching 3mm edges

Laminate Name	Lam No	Laminate Finish Grade		3mm edge	Laminate Name	Lam No	Laminate Finish Grade		3mm edge
		1	2				1	2	
MDF Solidz	7812	58		*R	Shoji Screen	3696	58		
Millennium Oak	5887	58		*R	Silver Oak Herringbone	9311	58		
Mineral Spa	6920	58		*R	Smoked Knotty Ash	6440	58		*F
Mission White	933	58		*F	Smoky Brown Pear	5488	58		*F
Mojave	8751	58			Smoky Walnut Woodline	6926	58		*R
Mouse	928	58		*F	Sol	3209	58		*R
Myriad Ribbonwood	863	58		*F	Sorrel Cherry	5886	43, 58		*F
Natural Ash	8843		***WR		Spectrum Blue	851	58		*F
Natural Birch	7481	58		*R	Spectrum Green	7897	58		
Natural Canvas	7022	58			Spectrum Red	845	58		*F
Natural Maple	756	58		std stock	Stone Grafix	503	58		std stock
Natural Oak	346	58		*F	Stop Red	839	58		*F
Natural Teak	8849	58		*F	Storm	912	58		std stock
Navy Blue	969	58		*R	Storm Hex	6474	58		
Navy Grafix	7018	58		*R	Storm Solidz	3505	58		*R
Neo Cloud	6314	58			Surf	923	58		*F
Neutral Twill	8826	58		std stock	Terril	2297	58		*R
Neutral Weft	5875	58		*R	Thermo Walnut	6402	43		*F
Neutral White	918	58		*F	Travertine	3526	58		
New Burgundy	7966	58			Vibrant Green	6901	58		*R
Nocturne	5323	58			Vosges Pear	1150	43		*F
Oiled Legno	8846	58		*F	Walnut Riftwood	9283		***NG	*F
Oiled Walnut	5487	58		*R	Waxed Maple	8905	58		
Otter	3202	58		*R	Weathered Ash	8842		***WR	*F
Oyster Gray	929	58		*R	Wenge Strand	6306	58		*R
Paloma Bisque	6729	58		*R	Wheat Strand	6212	58		*F
Paloma Dark Gray	6366	58		*R	White	949	58		std stock
Paloma Polar	6698	58		*R	White Ash	8841		***WR	*F
Parquet Latte	3453	58			White Drops	8824	58		*R
Pearl	934	58		*R	White Ice Granite	9476	43		
Pecan Woodline	5883	58		*F	White Onyx	827		***90	
Pencil Wood	7747	58		*R	White Twill	9285	58		*F
Planked Deluxe Pear	6206	43, 58		*R	Wild Cherry	5904	43, 58		*F
Planked Urban Oak	9312	58		*F	Winter Sky	8792	58		*R
Platinum	902	58		std stock					
Portico Marble	7735	58		*R					
Prestige Walnut	6209	43		std stock					
Pumice	858	58		std stock					
Rolled Steel	8917	58							
Sail White	463	58		*F					
Sail White Oxide	300	58							
Salvage Planked Elm	9480	58							
Sand Crystall	3517	58							
Sand Stone	7265	58							
Sarum Duotex	6447	58		*R					
Sarum Grey	2770	58		*R					
Sarum Twill	8827	58		*F					
Select Cherry	7759	43		std stock					

Please note: additional laminates and finishes may be available with additional fees and/or extended lead times  
 Contact Symphony for pricing and lead time information: [service@symphonytables.com](mailto:service@symphonytables.com)  
 Laminates and specific finishes may be discontinued by Formica or Wilsonart. For the most up to date information, contact your Formica or Wilsonart representative.

\*\*\*Note that waste fees may apply for Formica NG, WR or 90 finishes. Please email [service@symphonytables.com](mailto:service@symphonytables.com) for a quote.

# Losa tables

seated height  
12"H stretcher

For complete model number:

1. insert 2 letter stretcher option code:

**XC** - (1) 12" high stretcher centered under each piece of the top

**XO** - (1) 12" high stretcher offset under each piece of the top

\*specify offset stretcher placement - 1" or 6" from approach edge of top

**2XC** - (2) 12" high stretchers centered under each piece of the top  
stretchers come standard 6" apart for tables that are 24", 30" or 36" deep

Losa 30"H table			dimensions	1, 2 or 3 piece top	model no.	grade 1 list	grade 2 list
<b>XC</b> (1) 12"H stretcher <u>centered</u> under <u>each piece</u> of the top	<b>XO</b> (1) 12"H stretcher <u>offset</u> under <u>each piece</u> of the top. <i>specify 1" or 6" offset</i>	<b>2XC</b> (2) 12"H stretchers <u>centered</u> under <u>each piece</u> of the top 6" apart	24 x 48 x 30H	1	TLLOS24048S	PV 1,830	2,070
			24 x 54 x 30H	1	TLLOS24054S	PV 1,900	2,160
			24 x 60 x 30H	1	TLLOS24060S	PV 1,920	2,180
			24 x 66 x 30H	1	TLLOS24066S	PV 2,010	2,290
			24 x 72 x 30H	1	TLLOS24072S	PV 2,030	2,310
			24 x 84 x 30H	1	TLLOS24084S	PV 2,240	2,550
			24 x 96 x 30H	1	TLLOS24096S	PV 2,340	2,660
			30 x 48 x 30H	1	TLLOS30048S	PV 1,930	2,190
			30 x 54 x 30H	1	TLLOS30054S	PV 2,010	2,290
			30 x 60 x 30H	1	TLLOS30060S	PV 2,090	2,380
			30 x 66 x 30H	1	TLLOS30066S	PV 2,160	2,470
			30 x 72 x 30H	1	TLLOS30072S	PV 2,180	2,490
			30 x 84 x 30H	1	TLLOS30084S	PV 2,410	2,740
			30 x 96 x 30H	1	TLLOS30096S	PV 2,500	2,860
			36 x 48 x 30H	1	TLLOS36048S	PV 2,060	2,320
			36 x 54 x 30H	1	TLLOS36054S	PV 2,130	2,410
			36 x 60 x 30H	1	TLLOS36060S	PV 2,210	2,500
			36 x 66 x 30H	1	TLLOS36066S	PV 2,280	2,590
			36 x 72 x 30H	1	TLLOS36072S	PV 2,460	2,790
			36 x 84 x 30H	1	TLLOS36084S	PV 2,600	2,950
			36 x 96 x 30H	1	TLLOS36096S	PV 2,680	3,050
			24 x 120 x 30H	2	TLLOS24120S	PV 3,460	3,830
			24 x 144 x 30H	2	TLLOS24144S	PV 3,650	4,050
			24 x 192 x 30H	2	TLLOS24192S	PV 4,320	4,860
30 x 120 x 30H	2	TLLOS30120S	PV 3,860	4,260			
30 x 144 x 30H	2	TLLOS30144S	PV 4,290	4,840			
30 x 192 x 30H	2	TLLOS30192S	PV 5,030	5,680			
36 x 120 x 30H	2	TLLOS36120S	PV 4,200	4,620			
36 x 144 x 30H	2	TLLOS36144S	PV 4,580	5,040			
36 x 192 x 30H	2	TLLOS36192S	PV 5,470	6,050			
24 x 216 x 30H	3	TLLOS24216S	PV 5,210	5,820			
24 x 240 x 30H	3	TLLOS24240S	PV 5,550	6,220			
30 x 216 x 30H	3	TLLOS30216S	PV 5,720	6,380			
30 x 240 x 30H	3	TLLOS30240S	PV 6,090	6,820			
36 x 216 x 30H	3	TLLOS36216S	PV 6,110	6,740			
36 x 240 x 30H	3	TLLOS36240S	PV 6,470	7,180			

**Wire Management 3-sided Chase options:**

**Losa 3 sided laminate wire management chase with latches for 1 end panel base\***

Seated height chase (6"W x 3"D x 16.56"H) model # **OBLOSWM3SCE30-6** - \$330 list

**Losa 3 sided laminate wire management chase with latches for both end panel bases**

Seated height chase (6"W x 3"D x 16.56"H) model # **OBLOSWM3SC2E30-6** - \$660 list

**Losa 3 sided laminate wire management chase with latches for 1 middle support panel base\***

Seated height chase (6"W x 3"D x 16.56"H) model # **OBLOSWM3SCM30-6** - \$330 list

\* for tables with offset stretchers, specify which panel and the placement of the wire manager (user left or right)

**Wire Management Mouse Hole options:**

 Losa wire management mouse hole (1) stretcher at the top / center - model # **OBOLOSWMHHS** - \$20 list

 Losa wire management mouse hole (1) in the end panel or middle support panel at the top / center model # **OBOLOSWMHPT** - \$20 list

 Losa wire management mouse hole (1) in the end panel or middle support panel at the bottom / center model # **OBOLOSWMHPB** - \$20 list

**Wire Management cut out options for end /middle panels:**

 Losa wire management notched cut out for power supply (1) stretcher at top / center model # **OBOLOSWMNCOS** - \$60 list

 Losa wire management notched cut out for power supply (1) end panel or middle support panel at top / center model # **OBOLOSWMNCOP** - \$60 list

 Losa wire management cut out (1) on the end panel 18" at center from the bottom center of the panel model # **OBOLOSWMCOEP** - \$60 list

\*\*\*specify which panel or stretcher shall have the mouse hole or cut out on your PO

Please contact service@symphonytables.com to make sure that your power and/or wire management solution will work with the Losa table specification. We are able to modify this table with a custom solution to fit your projects needs.

# Losa tables

seated height  
12"H stretchers

Losa 30"H table			dimensions	model no.	grade 1 list	grade 2 list
<b>XC</b> (1) 12"H stretcher <u>centered</u> under <u>each piece</u> of the top	<b>XO</b> (1) 12"H stretcher <u>offset</u> under <u>each piece</u> of the top. <i>specify 1" or 6" offset</i>	<b>2XC</b> (2) 12"H stretchers <u>centered</u> under <u>each piece</u> of the top 6" apart	42 x 48 x 30H	TLLOS42048S2XCPV	2,110	2,380
			42 x 54 x 30H	TLLOS42054S2XCPV	2,200	2,480
			42 x 60 x 30H	TLLOS42060S2XCPV	2,270	2,570
			42 x 66 x 30H	TLLOS42066S2XCPV	2,350	2,670
			42 x 72 x 30H	TLLOS42072S2XCPV	2,530	2,870
			42 x 84 x 30H	TLLOS42084S2XCPV	2,670	3,040
			42 x 96 x 30H	TLLOS42096S2XCPV	2,820	3,220
			48 x 54 x 30H	TLLOS48054S2XCPV	2,400	2,740
			48 x 60 x 30H	TLLOS48060S2XCPV	2,490	2,850
			48 x 66 x 30H	TLLOS48066S2XCPV	2,580	2,950
			48 x 72 x 30H	TLLOS48072S2XCPV	2,780	3,170
			48 x 84 x 30H	TLLOS48084S2XCPV	2,800	3,200
			48 x 96 x 30H	TLLOS48096S2XCPV	2,820	3,220
			54 x 60 x 30H	TLLOS54060S2XCPV	3,190	3,620
			54 x 66 x 30H	TLLOS54066S2XCPV	3,300	3,740
			54 x 72 x 30H	TLLOS54072S2XCPV	3,400	3,870
			54 x 84 x 30H	TLLOS54084S2XCPV	3,430	3,900
			54 x 96 x 30H	TLLOS54096S2XCPV	3,450	3,930
			60 x 66 x 30H	TLLOS60066S2XCPV	3,620	4,040
			60 x 72 x 30H	TLLOS60072S2XCPV	3,710	4,160
			60 x 84 x 30H	TLLOS60084S2XCPV	3,730	4,180
			60 x 96 x 30H	TLLOS60096S2XCPV	3,760	4,210
			42 x 120 x 30H	TLLOS42120S2XCPV	4,650	5,110
			42 x 144 x 30H	TLLOS42144S2XCPV	5,100	5,610
42 x 192 x 30H	TLLOS42192S2XCPV	6,220	6,630			
48 x 120 x 30H	TLLOS48120S2XCPV	4,650	5,110			
48 x 144 x 30H	TLLOS48144S2XCPV	5,100	5,610			
48 x 192 x 30H	TLLOS48192S2XCPV	6,270	6,920			
54 x 120 x 30H	TLLOS54120S2XCPV	5,690	6,390			
54 x 144 x 30H	TLLOS54144S2XCPV	5,950	6,700			
54 x 192 x 30H	TLLOS54192S2XCPV	6,900	7,840			
60 x 120 x 30H	TLLOS60120S2XCPV	6,080	6,370			
60 x 144 x 30H	TLLOS60144S2XCPV	6,340	6,920			
60 x 192 x 30H	TLLOS60192S2XCPV	7,290	8,060			
42 x 216 x 30H	TLLOS42216S2XCPV	6,790	7,510			
42 x 240 x 30H	TLLOS42240S2XCPV	7,180	8,000			
48 x 216 x 30H	TLLOS48216S2XCPV	6,840	7,570			
48 x 240 x 30H	TLLOS48240S2XCPV	8,320	8,050			
54 x 216 x 30H	TLLOS54216S2XCPV	7,990	8,960			
54 x 240 x 30H	TLLOS54240S2XCPV	8,490	9,570			
60 x 216 x 30H	TLLOS60216S2XCPV	8,340	9,270			
60 x 240 x 30H	TLLOS60240S2XCPV	8,820	9,850			

**Wire Management 3-sided Chase options:**

**Losa 3 sided laminate wire management chase with latches for 1 end panel base**

Seated height chase (12"W x 3"D x 16.56"H) model # **OBLOSWM3SCE30-12** - \$330 list

**Losa 3 sided laminate wire management chase with latches for both end panel bases**

Seated height chase (12"W x 3"D x 16.56"H) model # **OBLOSWM3SC2E30-12** - \$660 list

**Losa 3 sided laminate wire management chase with latches for 1 middle support panel base**

Seated height chase (12"W x 3"D x 16.56"H) model # **OBLOSWM3SCM30-12** - \$330 list

**Wire Management Mouse Hole options:**

 Losa wire management mouse hole (1) stretcher at the top / center - model # **OBOLOSWMHHS** - \$20 list

 Losa wire management mouse hole (1) in the end panel or middle support panel at the top / center model # **OBOLOSWMHPT** - \$20 list

 Losa wire management mouse hole (1) in the end panel or middle support panel at the bottom / center model # **OBOLOSWMHPB** - \$20 list

**Wire Management cut out options for end /middle panels:**

 Losa wire management notched cut out for power supply (1) stretcher at top / center - model # **OBOLOSWMNCOS** - \$60 list

 Losa wire management notched cut out for power supply (1) end panel or middle support panel at top / center model # **OBOLOSWMNCOP** - \$60 list

 Losa wire management cut out (1) on the end panel 18" at center from the bottom center of the panel model # **OBOLOSWMCOEP** - \$60 list

\*\*\*specify which panel or stretcher shall have the mouse hole or cut out on your PO

# Losa tables

seated height  
full height stretcher



For complete model number:

1. insert 2 letter stretcher option code:

**FC** - (1) full height stretcher centered under each piece of the top

**FO** - (1) full height stretcher offset under each piece of the top

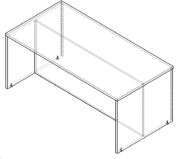
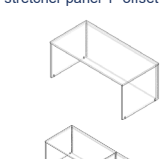
\*specify offset stretcher placement - 1" or 6" from approach edge of top



Losa 30"H table		dimensions	1, 2 or 3 piece top	model no.	grade 1 list	grade 2 list
<b>FC</b> (1) full height stretcher centered under each piece of the top 	<b>FO</b> (1) full height stretcher offset under each piece of the top specify 1" or 6" offset 	24 x 48 x 30H	1	TLLOS24048S	PV 2,090	2,370
		24 x 54 x 30H	1	TLLOS24054S	PV 2,190	2,490
		24 x 60 x 30H	1	TLLOS24060S	PV 2,210	2,510
		24 x 66 x 30H	1	TLLOS24066S	PV 2,340	2,670
		24 x 72 x 30H	1	TLLOS24072S	PV 2,360	2,690
		24 x 84 x 30H	1	TLLOS24084S	PV 2,640	3,000
		24 x 96 x 30H	1	TLLOS24096S	PV 2,780	3,170
		30 x 48 x 30H	1	TLLOS30048S	PV 2,190	2,490
		30 x 54 x 30H	1	TLLOS30054S	PV 2,290	2,610
		30 x 60 x 30H	1	TLLOS30060S	PV 2,390	2,730
		30 x 66 x 30H	1	TLLOS30066S	PV 2,490	2,850
		30 x 72 x 30H	1	TLLOS30072S	PV 2,510	2,880
		30 x 84 x 30H	1	TLLOS30084S	PV 2,800	3,200
		30 x 96 x 30H	1	TLLOS30096S	PV 2,940	3,370
		36 x 48 x 30H	1	TLLOS36048S	PV 2,300	2,600
		36 x 54 x 30H	1	TLLOS36054S	PV 2,410	2,730
		36 x 60 x 30H	1	TLLOS36060S	PV 2,510	2,850
		36 x 66 x 30H	1	TLLOS36066S	PV 2,610	2,960
		36 x 72 x 30H	1	TLLOS36072S	PV 2,810	3,190
		36 x 84 x 30H	1	TLLOS36084S	PV 2,990	3,410
36 x 96 x 30H	1	TLLOS36096S	PV 3,120	3,560		
		24 x 120 x 30H	2	TLLOS24120S	PV 3,990	4,450
		24 x 144 x 30H	2	TLLOS24144S	PV 4,270	4,770
		24 x 192 x 30H	2	TLLOS24192S	PV 5,120	5,800
		30 x 120 x 30H	2	TLLOS30120S	PV 4,390	4,880
		30 x 144 x 30H	2	TLLOS30144S	PV 4,910	5,460
		30 x 192 x 30H	2	TLLOS30192S	PV 5,830	6,550
		36 x 120 x 30H	2	TLLOS36120S	PV 4,730	5,240
		36 x 144 x 30H	2	TLLOS36144S	PV 5,200	5,760
		36 x 192 x 30H	2	TLLOS36192S	PV 6,130	6,880
		24 x 216 x 30H	3	TLLOS24216S	PV 6,100	6,860
24 x 240 x 30H	3	TLLOS24240S	PV 6,530	7,380		
30 x 216 x 30H	3	TLLOS30216S	PV 6,610	7,430		
30 x 240 x 30H	3	TLLOS30240S	PV 7,060	7,980		
36 x 216 x 30H	3	TLLOS36216S	PV 6,930	7,760		
36 x 240 x 30H	3	TLLOS36240S	PV 7,390	8,320		

### Wire Management Door option:



- Losa wire management door with finger pull for 1 full height stretcher\*\***  
(door dimensions: 10.5"W x 12.5"H) model # OBOLOSAMD1 - \$200 list
- Losa wire management door with finger pull for 2 full height stretchers\*\***  
(door dimensions: 10.5"W x 12.5"H) model # OBOLOSAMD2 - \$400 list
- Losa wire management door with finger pull for 3 full height stretchers\*\***  
(door dimensions: 10.5"W x 12.5"H) model # OBOLOSAMD3 - \$600 list

\*\*specify placement and confirm which panel shall receive the door for tables with multiple stretchers

### Wire Management Mouse Hole options:

-  Losa wire management mouse hole (1) stretcher at the top / center - model # OBOLOSMMHHS - \$20 list
-  Losa wire management mouse hole (1) in the end panel or middle support panel at the top / center model # OBOLOSMMHPT - \$20 list
-  Losa wire management mouse hole (1) in the end panel or middle support panel at the bottom / center model # OBOLOSMMHPB - \$20 list

### Wire Management cut out options for end /middle panels:



-  Losa wire management notched cut out for power supply (1) stretcher at top / center model # OBOLOSMMNCOS - \$60 list
-  Losa wire management notched cut out for power supply (1) end panel or middle support panel at top / center model # OBOLOSMMNCOP - \$60 list
-  Losa wire management cut out (1) on the end panel 18" at center from the bottom center of the panel model # OBOLOSMMCOEP - \$60 list

\*\*\*specify which panel or stretcher shall have the mouse hole or cut out on your PO

Please contact service@symphonytables.com to make sure that your power and/or wire management solution will work with the Losa table specification. We are able to modify this table with a custom solution to fit your projects needs.

# Losa tables

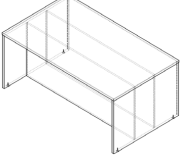
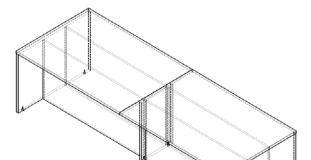
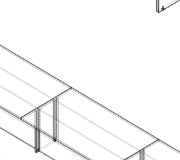
seated height  
full height stretchers



Losa 30"H table		dimensions	1, 2 or 3 piece top	model no.	grade 1 list	grade 2 list
<b>(2) full height stretchers centered under each piece of the top stretchers 6" apart</b> 		24 x 48 x 30H	1	TLLOS24048S2FCPV	2,350	2,660
		24 x 54 x 30H	1	TLLOS24054S2FCPV	2,470	2,810
		24 x 60 x 30H	1	TLLOS24060S2FCPV	2,520	2,860
		24 x 66 x 30H	1	TLLOS24066S2FCPV	2,670	3,040
		24 x 72 x 30H	1	TLLOS24072S2FCPV	2,710	3,090
		24 x 84 x 30H	1	TLLOS24084S2FCPV	3,030	3,460
		24 x 96 x 30H	1	TLLOS24096S2FCPV	3,220	3,680
		30 x 48 x 30H	1	TLLOS30048S2FCPV	2,450	2,780
		30 x 54 x 30H	1	TLLOS30054S2FCPV	2,580	2,940
		30 x 60 x 30H	1	TLLOS30060S2FCPV	2,700	3,080
		30 x 66 x 30H	1	TLLOS30066S2FCPV	2,820	3,220
		30 x 72 x 30H	1	TLLOS30072S2FCPV	2,860	3,280
		30 x 84 x 30H	1	TLLOS30084S2FCPV	3,200	3,660
		30 x 96 x 30H	1	TLLOS30096S2FCPV	3,380	3,880
		36 x 48 x 30H	1	TLLOS36048S2FCPV	2,570	2,900
		36 x 54 x 30H	1	TLLOS36054S2FCPV	2,690	3,050
		36 x 60 x 30H	1	TLLOS36060S2FCPV	2,820	3,200
		36 x 66 x 30H	1	TLLOS36066S2FCPV	2,930	3,340
		36 x 72 x 30H	1	TLLOS36072S2FCPV	3,170	3,590
		36 x 84 x 30H	1	TLLOS36084S2FCPV	3,390	3,860
36 x 96 x 30H	1	TLLOS36096S2FCPV	3,560	4,070		
		24 x 120 x 30H	2	TLLOS24120S2FCPV	4,520	5,060
		24 x 144 x 30H	2	TLLOS24144S2FCPV	4,880	5,500
		24 x 192 x 30H	2	TLLOS24192S2FCPV	5,910	6,730
		30 x 120 x 30H	2	TLLOS30120S2FCPV	4,920	5,500
		30 x 144 x 30H	2	TLLOS30144S2FCPV	5,530	6,180
		30 x 192 x 30H	2	TLLOS30192S2FCPV	6,620	7,490
		36 x 120 x 30H	2	TLLOS36120S2FCPV	5,260	5,850
		36 x 144 x 30H	2	TLLOS36144S2FCPV	5,820	6,480
		36 x 192 x 30H	2	TLLOS36192S2FCPV	6,930	7,820
		24 x 216 x 30H	3	TLLOS24216S2FCPV	6,990	7,910
24 x 240 x 30H	3	TLLOS24240S2FCPV	7,500	8,530		
30 x 216 x 30H	3	TLLOS30216S2FCPV	7,500	8,470		
30 x 240 x 30H	3	TLLOS30240S2FCPV	8,040	9,130		
36 x 216 x 30H	3	TLLOS36216S2FCPV	7,810	8,810		
36 x 240 x 30H	3	TLLOS36240S2FCPV	8,370	9,470		

### Wire Management Door option:



- Losa wire management door with finger pull for 1 full height stretcher\*\***  
(door dimensions: 10.5"W x 12.5"H) model # OBOLOSAMD1 - \$200 list
- Losa wire management door with finger pull for 2 full height stretchers\*\***  
(door dimensions: 10.5"W x 12.5"H) model # OBOLOSAMD2 - \$400 list
- Losa wire management door with finger pull for 3 full height stretchers\*\***  
(door dimensions: 10.5"W x 12.5"H) model # OBOLOSAMD3 - \$600 list

\*\*specify placement and confirm which panel shall receive the door for tables with multiple stretchers

### Wire Management Mouse Hole options:

-  Losa wire management mouse hole (1) stretcher at the top / center - model # OBOLOSMMHHS - \$20 list
-  Losa wire management mouse hole (1) in the end panel or middle support panel at the top / center - model # OBOLOSMMHPT - \$20 list
-  Losa wire management mouse hole (1) in the end panel or middle support panel at the bottom / center model # OBOLOSMMHPB - \$20 list

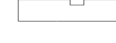
### Wire Management cut out options for end /middle panels:

-  Losa wire management notched cut out for power supply (1) stretcher at top / center model # OBOLOSMMNCOS - \$60 list
-  Losa wire management notched cut out for power supply (1) end panel or middle support panel at top / center model # OBOLOSMMNCOP - \$60 list
-  Losa wire management cut out (1) on the end panel 18" at center from the bottom center of the panel model # OBOLOSMMCOEP - \$60 list

\*\*\*specify which panel or stretcher shall have the mouse hole or cut out on your PO

Please contact service@symphonytables.com to make sure that your power and/or wire management solution will work with the Losa table specification. We are able to modify this table with a custom solution to fit your projects needs.

# Losa tables

seated height  
full height stretchers

# Losa tables

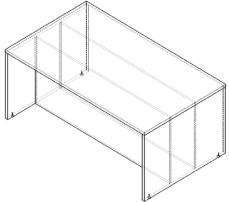
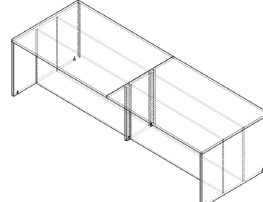
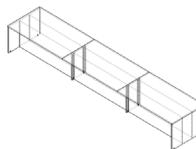
Losa 30"H table	dimensions	model no.	grade 1 list	grade 2 list	
1 piece top - (2) full height stretchers centered under the top stretchers 12" apart 	42 x 48 x 30H	TLLOS42048S2FCPV	2,620	2,970	
	42 x 54 x 30H	TLLOS42054S2FCPV	2,750	3,120	
	42 x 60 x 30H	TLLOS42060S2FCPV	2,880	3,270	
	42 x 66 x 30H	TLLOS42066S2FCPV	3,000	3,420	
	42 x 72 x 30H	TLLOS42072S2FCPV	3,240	3,680	
	42 x 84 x 30H	TLLOS42084S2FCPV	3,470	3,950	
	42 x 96 x 30H	TLLOS42096S2FCPV	3,710	4,240	
	48 x 54 x 30H	TLLOS48054S2FCPV	2,970	3,380	
	48 x 60 x 30H	TLLOS48060S2FCPV	3,110	3,550	
	48 x 66 x 30H	TLLOS48066S2FCPV	3,240	3,710	
	48 x 72 x 30H	TLLOS48072S2FCPV	3,490	3,980	
	48 x 84 x 30H	TLLOS48084S2FCPV	3,600	4,110	
	48 x 96 x 30H	TLLOS48096S2FCPV	3,710	4,240	
	54 x 60 x 30H	TLLOS54060S2FCPV	3,810	4,320	
	54 x 66 x 30H	TLLOS54066S2FCPV	3,960	4,500	
	54 x 72 x 30H	TLLOS54072S2FCPV	4,100	4,670	
	54 x 84 x 30H	TLLOS54084S2FCPV	4,220	4,810	
	54 x 96 x 30H	TLLOS54096S2FCPV	4,340	4,950	
	60 x 66 x 30H	TLLOS60066S2FCPV	4,190	4,730	
	60 x 72 x 30H	TLLOS60072S2FCPV	4,330	4,900	
	60 x 84 x 30H	TLLOS60084S2FCPV	4,450	5,040	
	60 x 96 x 30H	TLLOS60096S2FCPV	4,570	5,180	
	2 piece top - (2) full height stretchers centered under each piece of the stretchers 12" apart 	42 x 120 x 30H	TLLOS42120S2FCPV	5,710	6,350
		42 x 144 x 30H	TLLOS42144S2FCPV	6,340	7,060
		42 x 192 x 30H	TLLOS42192S2FCPV	7,540	8,510
		48 x 120 x 30H	TLLOS48120S2FCPV	5,710	6,350
		48 x 144 x 30H	TLLOS48144S2FCPV	6,340	7,060
48 x 192 x 30H		TLLOS48192S2FCPV	7,660	8,620	
54 x 120 x 30H		TLLOS54120S2FCPV	6,640	7,370	
54 x 144 x 30H		TLLOS54144S2FCPV	7,080	7,900	
54 x 192 x 30H		TLLOS54192S2FCPV	8,440	9,530	
60 x 120 x 30H		TLLOS60120S2FCPV	6,870	7,600	
60 x 144 x 30H		TLLOS60144S2FCPV	7,310	8,130	
60 x 192 x 30H		TLLOS60192S2FCPV	8,670	9,770	
3 piece top - (2) full height stretchers centered under each piece of the stretchers 12" apart 	42 x 216 x 30H	TLLOS42216S2FCPV	8,470	9,550	
	42 x 240 x 30H	TLLOS42240S2FCPV	9,080	10,280	
	48 x 216 x 30H	TLLOS48216S2FCPV	8,470	9,550	
	48 x 240 x 30H	TLLOS48240S2FCPV	9,080	10,280	
	54 x 216 x 30H	TLLOS54216S2FCPV	9,760	11,050	
	54 x 240 x 30H	TLLOS54240S2FCPV	10,440	11,870	
	60 x 216 x 30H	TLLOS60216S2FCPV	9,990	11,290	
	60 x 240 x 30H	TLLOS60240S2FCPV	10,680	12,110	

**Wire Management Door option:**

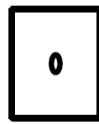

**Losa wire management door with finger pull for 1 full height stretcher\*\***  
(door dimensions: 10.5"W x 12.5"H) model # **OBOLOSWMDD1** - \$200 list  
**Losa wire management door with finger pull for 2 full height stretchers\*\***  
(door dimensions: 10.5"W x 12.5"H) model # **OBOLOSWMDD2** - \$400 list  
**Losa wire management door with finger pull for 3 full height stretchers\*\***  
(door dimensions: 10.5"W x 12.5"H) model # **OBOLOSWMDD3** - \$600 list

\*\*specify placement and confirm which panel shall receive the door for tables with multiple stretchers

**Wire Management Mouse Hole options:**

 Losa wire management mouse hole (1) stretcher at the top / center - model # **OBOLOSWMHHS** - \$20 list

 Losa wire management mouse hole (1) in the end panel or middle support panel at the top / center model # **OBOLOSWMHPT** - \$20 list

 Losa wire management mouse hole (1) in the end panel or middle support panel at the bottom / center model # **OBOLOSWMHPB** - \$20 list

**Wire Management cut out options for end /middle panels:**

 Losa wire management notched cut out for power supply (1) stretcher at top / center model # **OBOLOSWMNCOS** - \$60 list

 Losa wire management notched cut out for power supply (1) end panel or middle support panel at top / center - model # **OBOLOSWMNCOP** - \$60 list

 Losa wire management cut out (1) on the end panel 18" at center from the bottom center of the panel model # **OBOLOSWMCOEP** - \$60 list

\*\*\*specify which panel or stretcher shall have the mouse hole or cut out on your PO

Please contact [service@symphonytables.com](mailto:service@symphonytables.com) to make sure that your power and/or wire management solution will work with the Losa table specification. We are able to modify this table with a custom solution to fit your projects needs.



# Losa tables

counter height or bar height  
12"H stretcher

For complete model number:  
1. insert 1 letter height code:  
**C** - 36" counter height  
**B** - 42" bar height

2. insert 2 letter stretcher option code:  
**XC** - (1) 12" high stretcher centered under each piece of the top  
**XO** - (1) 12" high stretcher offset under each piece of the top  
\*specify offset stretcher placement - 1" or 6" from approach edge of top  
**2XC** - (2) 12" high stretchers centered under each piece of the top  
stretchers come standard 6" apart for tops that are 24", 30" or 36" deep

Losa table	dimensions	1, 2 or 3 piece top	model no.	grade 1 list	grade 2 list	
<b>XC (1) 12"H stretcher centered under each piece of the top</b>	24 x 48	1	TLLOS24048	PV 1,950	2,210	
	24 x 54	1	TLLOS24054	PV 2,030	2,310	
	24 x 60	1	TLLOS24060	PV 2,030	2,310	
	24 x 66	1	TLLOS24066	PV 2,140	2,450	
	24 x 72	1	TLLOS24072	PV 2,140	2,450	
	24 x 84	1	TLLOS24084	PV 2,380	2,720	
	24 x 96	1	TLLOS24096	PV 2,500	2,860	
	30 x 48	1	TLLOS30048	PV 2,110	2,410	
	30 x 54	1	TLLOS30054	PV 2,200	2,520	
	30 x 60	1	TLLOS30060	PV 2,200	2,520	
	30 x 66	1	TLLOS30066	PV 2,320	2,660	
	<b>XO (1) 12"H stretcher offset under each piece of the top. specify 1" or 6" offset</b>	30 x 72	1	TLLOS30072	PV 2,320	2,660
30 x 84		1	TLLOS30084	PV 2,580	2,950	
30 x 96		1	TLLOS30096	PV 2,680	3,070	
36 x 48		1	TLLOS36048	PV 2,170	2,460	
36 x 54		1	TLLOS36054	PV 2,260	2,570	
36 x 60		1	TLLOS36060	PV 2,350	2,670	
36 x 66		1	TLLOS36066	PV 2,430	2,770	
36 x 72		1	TLLOS36072	PV 2,620	2,980	
36 x 84		1	TLLOS36084	PV 2,770	3,160	
36 x 96		1	TLLOS36096	PV 2,870	3,270	
<b>2XC (2) 12"H stretchers centered under each piece of the top 6" apart</b>		24 x 120	2	TLLOS24120	PV 3,650	4,050
		24 x 144	2	TLLOS24144	PV 3,850	4,300
	24 x 192	2	TLLOS24192	PV 4,590	5,190	
	30 x 120	2	TLLOS30120	PV 4,060	4,500	
	30 x 144	2	TLLOS30144	PV 4,520	5,000	
	30 x 192	2	TLLOS30192	PV 5,320	5,970	
	36 x 120	2	TLLOS36120	PV 4,410	4,870	
	36 x 144	2	TLLOS36144	PV 4,810	5,310	
	36 x 192	2	TLLOS36192	PV 5,640	6,310	
	24 x 216	3	TLLOS24216	PV 5,520	6,190	
	24 x 240	3	TLLOS24240	PV 5,890	6,640	
	30 x 216	3	TLLOS30216	PV 6,050	6,780	
30 x 240	3	TLLOS30240	PV 6,460	7,270		
36 x 216	3	TLLOS36216	PV 6,380	7,130		
36 x 240	3	TLLOS36240	PV 6,800	7,630		

**Wire Management 3-sided Chase options:**

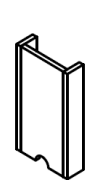

**Losa 3 sided laminate wire management chase with latches for 1 end panel base\***

Counter height chase (22.56"H) model # **OBLOSWM3SCE36-6** - \$350 list

Bar height chase (28.56"H) model # **OBLOSWM3SCE42-6** - \$370 list

**Losa 3 sided laminate wire management chase with latches for both end panel bases**

Counter height chase (22.56"H) model # **OBLOSWM3SC2E36-6** - \$700 list

Bar height chase (28.56"H) model # **OBLOSWM3SC2E42-6** - \$740 list

**Losa 3 sided laminate wire management chase with latches for 1 middle panel base\***

Counter height chase (22.56"H) model # **OBLOSWM3SCM36-6** - \$350 list

Bar height chase (28.56"H) model # **OBLOSWM3SCM42-6** - \$370 list

**\*for tables with offset stretchers, specify which panel and the placement of the wire manager (user left or right)**

**Wire Management Mouse Hole options:**

 Losa wire management mouse hole (1) stretcher at the top / center - model # **OBOLOSWMHHS** - \$20 list

 Losa wire management mouse hole (1) in the end panel or middle support panel at the top / center - model # **OBOLOSWMHPT** - \$20 list

 Losa wire management mouse hole (1) in the end panel or middle support panel at the bottom / center - model # **OBOLOSWMHPB** - \$20 list

**Wire Management cut out options for end /middle panels:**

 Losa wire management notched cut out for power supply (1) stretcher at top / center - model # **OBOLOSWMNCOS** - \$60 list

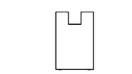
 Losa wire management notched cut out for power supply (1) end panel or middle support panel at top / center - model # **OBOLOSWMNCOP** - \$60 list

 Losa wire management cut out (1) on the end panel 18" at center from the bottom center of the panel - model # **OBOLOSWMCOEP** - \$60 list

**\*\*specify which panel or stretcher shall have the mouse hole or cut out on your PO**

Please contact [service@symphonytables.com](mailto:service@symphonytables.com) to make sure that your power and/or wire management solution will work with the Losa table specification. We are able to modify this table with a custom solution to fit your projects needs.

# Losa tables

counter height or bar height  
12"H stretcher

For complete model number - insert 1 letter height code:  
**C** - 36" counter height  
**B** - 42" bar height

Losa table - stretchers 12" apart	dimensions	model no.	grade 1 list	grade 2 list	
<b>1 piece top - (2) 12"H stretchers centered under the top</b>	42 x 48	TLLOS42048	2XCPV 2,230	2,540	
	42 x 54	TLLOS42054	2XCPV 2,330	2,650	
	42 x 60	TLLOS42060	2XCPV 2,420	2,760	
	42 x 66	TLLOS42066	2XCPV 2,500	2,860	
	42 x 72	TLLOS42072	2XCPV 2,700	3,070	
	42 x 84	TLLOS42084	2XCPV 2,860	3,260	
	42 x 96	TLLOS42096	2XCPV 3,030	3,460	
	48 x 54	TLLOS48054	2XCPV 2,330	2,650	
	48 x 60	TLLOS48060	2XCPV 2,420	2,760	
	48 x 66	TLLOS48066	2XCPV 2,500	2,860	
	48 x 72	TLLOS48072	2XCPV 2,700	3,070	
	48 x 84	TLLOS48084	2XCPV 2,720	3,100	
	48 x 96	TLLOS48096	2XCPV 3,030	3,460	
	54 x 60	TLLOS54060	2XCPV 3,400	3,870	
	54 x 66	TLLOS54066	2XCPV 3,520	4,010	
	54 x 72	TLLOS54072	2XCPV 3,630	4,150	
	54 x 84	TLLOS54084	2XCPV 3,660	4,180	
	54 x 96	TLLOS54096	2XCPV 3,690	4,220	
	60 x 66	TLLOS60066	2XCPV 3,750	4,240	
	60 x 72	TLLOS60072	2XCPV 3,870	4,380	
	60 x 84	TLLOS60084	2XCPV 3,890	4,410	
	60 x 96	TLLOS60096	2XCPV 3,930	4,450	
	<b>2 piece top - (2) 12"H stretchers centered under each piece of the top</b>	42 x 120	TLLOS42120	2XCPV 4,880	5,390
		42 x 144	TLLOS42144	2XCPV 5,350	5,910
42 x 192		TLLOS42192	2XCPV 6,280	7,030	
48 x 120		TLLOS48120	2XCPV 4,880	5,390	
48 x 144		TLLOS48144	2XCPV 5,350	5,910	
48 x 192		TLLOS48192	2XCPV 6,400	7,140	
54 x 120		TLLOS54120	2XCPV 5,850	6,470	
54 x 144		TLLOS54144	2XCPV 6,150	6,820	
54 x 192		TLLOS54192	2XCPV 7,250	8,140	
60 x 120		TLLOS60120	2XCPV 6,090	6,700	
60 x 144		TLLOS60144	2XCPV 6,380	7,050	
60 x 192		TLLOS60192	2XCPV 7,480	8,380	
<b>3 piece top - (2) 12"H stretchers centered under each piece of the top</b>	42 x 216	TLLOS42216	2XCPV 7,070	7,910	
	42 x 240	TLLOS42240	2XCPV 7,540	8,470	
	48 x 216	TLLOS48216	2XCPV 7,070	7,910	
	48 x 240	TLLOS48240	2XCPV 7,540	8,470	
	54 x 216	TLLOS54216	2XCPV 8,470	9,550	
	54 x 240	TLLOS54240	2XCPV 9,030	10,210	
	60 x 216	TLLOS60216	2XCPV 8,710	9,780	
	60 x 240	TLLOS60240	2XCPV 9,260	10,440	

**Wire Management 3-sided Chase options:**



**Losa 3 sided laminate wire management chase with latches for 1 end panel base**

Counter height chase (22.56"H) model # **OBLOSWM3SCE36-12** - \$350 list

Bar height chase (28.56"H) model # **OBLOSWM3SCE42-12** - \$370 list

**Losa 3 sided laminate wire management chase with latches for both end panel bases**

Counter height chase (22.56"H) model # **OBLOSWM3SC2E36-12** - \$700 list

Bar height chase (28.56"H) model # **OBLOSWM3SC2E42-12** - \$740 list

**Losa 3 sided laminate wire management chase with latches for 1 middle panel base**

Counter height chase (22.56"H) model # **OBLOSWM3SCM36-12** - \$350 list

Bar height chase (28.56"H) model # **OBLOSWM3SCM42-12** - \$370 list

**Wire Management Mouse Hole options:**

 Losa wire management mouse hole (1) stretcher at the top / center - model # **OBOLOSWMHHS** - \$20 list

 Losa wire management mouse hole (1) in the end panel or middle support panel at the top / center - model # **OBOLOSWMHPT** - \$20 list

 Losa wire management mouse hole (1) in the end panel or middle support panel at the bottom / center - model # **OBOLOSWMHPB** - \$20 list

**Wire Management cut out options for end /middle panels:**

 Losa wire management notched cut out for power supply (1) stretcher at top / center model # **OBOLOSWMNCOS** - \$60 list

 Losa wire management notched cut out for power supply (1) end panel or middle support panel at top / center - model # **OBOLOSWMNCOP** - \$60 list

 Losa wire management cut out (1) on the end panel 18" at center from the bottom center of the panel - model # **OBOLOSWMCOEP** - \$60 list

# Losa tables

counter height or bar height  
full height stretcher

For complete model number:

1. insert 1 letter height code:  
**C** - 36" counter height  
**B** - 42" bar height

2. insert 2 letter stretcher option code:

- FC** - (1) full height stretcher centered under each piece of the top  
**FO** - (1) full height stretcher offset under each piece of the top

\*specify offset stretcher placement - 1" or 6" from approach edge of top

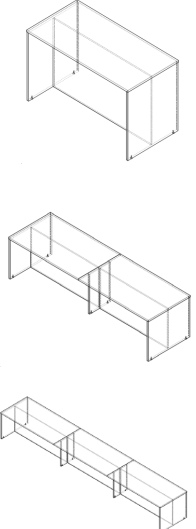
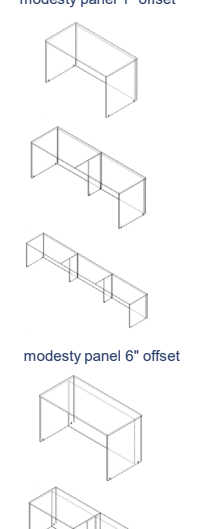
Losa table		dimensions	1, 2 or 3 piece top	model no.	grade 1 list	grade 2 list		
<b>FC</b> (1) full height stretcher centered under each piece of the top		24 x 48	1	TLLOS24048 ___ PV	2,210	2,510		
		24 x 54	1	TLLOS24054 ___ PV	2,310	2,640		
		24 x 60	1	TLLOS24060 ___ PV	2,340	2,660		
		24 x 66	1	TLLOS24066 ___ PV	2,470	2,820		
		24 x 72	1	TLLOS24072 ___ PV	2,490	2,850		
		24 x 84	1	TLLOS24084 ___ PV	2,780	3,170		
		24 x 96	1	TLLOS24096 ___ PV	2,940	3,370		
		30 x 48	1	TLLOS30048 ___ PV	2,370	2,710		
		30 x 54	1	TLLOS30054 ___ PV	2,490	2,850		
		30 x 60	1	TLLOS30060 ___ PV	2,510	2,870		
		30 x 66	1	TLLOS30066 ___ PV	2,650	3,040		
		30 x 72	1	TLLOS30072 ___ PV	2,670	3,070		
		30 x 84	1	TLLOS30084 ___ PV	2,980	3,410		
		30 x 96	1	TLLOS30096 ___ PV	3,120	3,580		
		36 x 48	1	TLLOS36048 ___ PV	2,430	2,760		
		36 x 54	1	TLLOS36054 ___ PV	2,550	2,890		
		36 x 60	1	TLLOS36060 ___ PV	2,650	3,020		
		36 x 66	1	TLLOS36066 ___ PV	2,760	3,150		
		36 x 72	1	TLLOS36072 ___ PV	2,970	3,380		
		36 x 84	1	TLLOS36084 ___ PV	3,170	3,620		
		36 x 96	1	TLLOS36096 ___ PV	3,310	3,780		
		<b>FO</b> (1) full height stretcher offset under each piece of the top specify 1" or 6" offset		24 x 120	2	TLLOS24120 ___ PV	4,180	4,670
				24 x 144	2	TLLOS24144 ___ PV	4,470	5,020
24 x 192	2			TLLOS24192 ___ PV	5,390	6,130		
30 x 120	2			TLLOS30120 ___ PV	4,590	5,120		
30 x 144	2			TLLOS30144 ___ PV	5,140	5,730		
30 x 192	2			TLLOS30192 ___ PV	6,120	6,910		
36 x 120	2			TLLOS36120 ___ PV	4,940	5,490		
36 x 144	2			TLLOS36144 ___ PV	5,430	6,040		
36 x 192	2			TLLOS36192 ___ PV	6,440	7,250		
24 x 216	3			TLLOS24216 ___ PV	6,410	7,240		
24 x 240	3			TLLOS24240 ___ PV	6,870	7,790		
30 x 216	3			TLLOS30216 ___ PV	6,940	7,830		
30 x 240	3	TLLOS30240 ___ PV	7,430	8,420				
36 x 216	3	TLLOS36216 ___ PV	7,270	8,180				
36 x 240	3	TLLOS36240 ___ PV	7,770	8,780				



**Wire Management Door option:**





- Losa wire management door with finger pull for 1 full height stretcher\*\***  
(door dimensions: 10.5"W x 12.5"H) model # OBOLOSWMDD1 - \$200 list
- Losa wire management door with finger pull for 2 full height stretchers\*\***  
(door dimensions: 10.5"W x 12.5"H) model # OBOLOSWMDD2 - \$400 list
- Losa wire management door with finger pull for 3 full height stretchers\*\***  
(door dimensions: 10.5"W x 12.5"H) model # OBOLOSWMDD3 - \$600 list

\*\*specify placement and confirm which panel shall receive the door for tables with multiple stretchers

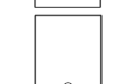
**Wire Management Mouse Hole options:**

-  Losa wire management mouse hole (1) stretcher at the top / center - model # OBOLOSWMHHS - \$20 list
-  Losa wire management mouse hole (1) in the end panel or middle support panel at the top / center - model # OBOLOSWMHPT - \$20 list
-  Losa wire management mouse hole (1) in the end panel or middle support panel at the bottom / center - model # OBOLOSWMHPB - \$20 list

**Wire Management cut out options for end /middle**

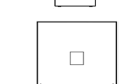
-  Losa wire management notched cut out for power supply (1) stretcher at top / center model # OBOLOSWMNCOS - \$60 list
-  Losa wire management notched cut out for power supply (1) end panel or middle support panel at top / center model # OBOLOSWMNCOP - \$60 list
-  Losa wire management cut out (1) on the end panel 18" at center from the bottom center of the panel model # OBOLOSWMCOEP - \$60 list

\*\*\*specify which panel or stretcher shall have the mouse hole or cut out on your PO

Please contact [service@symphonytables.com](mailto:service@symphonytables.com) to make sure that your power and/or wire management solution will work with the Losa table specification. We are able to modify this table with a custom solution to fit your projects needs.

# Losa tables

counter height or bar height  
full height stretcher

For complete model number - insert 1 letter height code:

- C** - 36" counter height  
**B** - 42" bar height

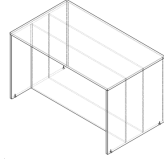
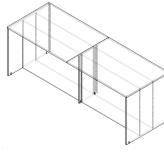
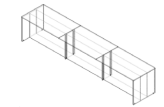
Losa table - stretchers 12" apart		dimensions	model no.	grade 1 list	grade 2 list		
1 piece top - (2) full height stretchers centered under the top stretchers 12" apart		24 x 48	TLLOS24048 _2FCPV	2,470	2,810		
		24 x 54	TLLOS24054 _2FCPV	2,600	2,960		
		24 x 60	TLLOS24060 _2FCPV	2,640	3,010		
		24 x 66	TLLOS24066 _2FCPV	2,800	3,200		
		24 x 72	TLLOS24072 _2FCPV	2,840	3,250		
		24 x 84	TLLOS24084 _2FCPV	3,180	3,630		
		24 x 96	TLLOS24096 _2FCPV	3,380	3,880		
		30 x 48	TLLOS30048 _2FCPV	2,630	3,000		
		30 x 54	TLLOS30054 _2FCPV	2,770	3,170		
		30 x 60	TLLOS30060 _2FCPV	2,820	3,220		
		30 x 66	TLLOS30066 _2FCPV	2,980	3,420		
		30 x 72	TLLOS30072 _2FCPV	3,020	3,470		
		30 x 84	TLLOS30084 _2FCPV	3,370	3,870		
		30 x 96	TLLOS30096 _2FCPV	3,560	4,090		
		36 x 48	TLLOS36048 _2FCPV	2,700	3,050		
		36 x 54	TLLOS36054 _2FCPV	2,830	3,220		
		36 x 60	TLLOS36060 _2FCPV	2,960	3,370		
		36 x 66	TLLOS36066 _2FCPV	3,090	3,520		
		36 x 72	TLLOS36072 _2FCPV	3,330	3,790		
		36 x 84	TLLOS36084 _2FCPV	3,560	4,070		
		36 x 96	TLLOS36096 _2FCPV	3,750	4,290		
		2 piece top - (2) full height stretchers centered under each piece of the stretchers 12" apart		24 x 120	TLLOS24120 _2FCPV	4,710	5,290
				24 x 144	TLLOS24144 _2FCPV	5,090	5,750
24 x 192	TLLOS24192 _2FCPV			6,190	7,060		
30 x 120	TLLOS30120 _2FCPV			5,120	5,740		
30 x 144	TLLOS30144 _2FCPV			5,750	6,450		
30 x 192	TLLOS30192 _2FCPV			6,920	7,850		
3 piece top - (2) full height stretchers centered under each piece of the stretchers 12" apart		36 x 120	TLLOS36120 _2FCPV	5,470	6,100		
		36 x 144	TLLOS36144 _2FCPV	6,050	6,760		
		36 x 192	TLLOS36192 _2FCPV	7,240	8,180		
		24 x 216	TLLOS24216 _2FCPV	7,300	8,280		
		24 x 240	TLLOS24240 _2FCPV	7,850	8,940		
		30 x 216	TLLOS30216 _2FCPV	7,830	8,870		
30 x 240	TLLOS30240 _2FCPV	8,410	9,570				
36 x 216	TLLOS36216 _2FCPV	8,160	9,220				
36 x 240	TLLOS36240 _2FCPV	8,750	9,930				



**Wire Management Door option:**





- Losa wire management door with finger pull for 1 full height stretcher\*\***  
(door dimensions: 10.5"W x 12.5"H) model # OBOLOSWMDD1 - \$200 list
- Losa wire management door with finger pull for 2 full height stretchers\*\***  
(door dimensions: 10.5"W x 12.5"H) model # OBOLOSWMDD2 - \$400 list
- Losa wire management door with finger pull for 3 full height stretchers\*\***  
(door dimensions: 10.5"W x 12.5"H) model # OBOLOSWMDD3 - \$600 list

\*\*specify placement and confirm which panel shall receive the door for tables with multiple stretchers

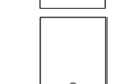
**Wire Management Mouse Hole options:**

-  Losa wire management mouse hole (1) stretcher at the top / center - model # OBOLOSWMHHS - \$20 list
-  Losa wire management mouse hole (1) in the end panel or middle support panel at the top / center - model # OBOLOSWMHPT - \$20 list
-  Losa wire management mouse hole (1) in the end panel or middle support panel at the bottom / center - model # OBOLOSWMHPB - \$20 list

**Wire Management cut out options for end /middle panels:**

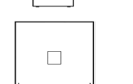
-  Losa wire management notched cut out for power supply (1) stretcher at top / center model # OBOLOSWMNCOS - \$60 list
-  Losa wire management notched cut out for power supply (1) end panel or middle support panel at top / center model # OBOLOSWMNCOP - \$60 list
-  Losa wire management cut out (1) on the end panel 18" at center from the bottom center of the panel model # OBOLOSWMCOEP - \$60 list

\*\*\*specify which panel or stretcher shall have the mouse hole or cut out on your PO

Please contact [service@symphonytables.com](mailto:service@symphonytables.com) to make sure that your power and/or wire management solution will work with the Losa table specification. We are able to modify this table with a custom solution to fit your projects needs.

# Losa tables

counter height or bar height  
full height stretchers

For complete model number - insert 1 letter height code:

**C** - 36" counter height

**B** - 42" bar height

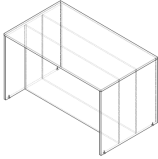
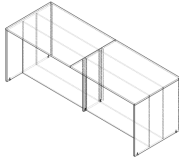
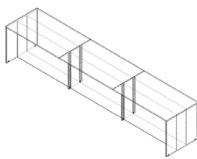
Losa table - stretchers 12" apart	dimensions	model no.	grade 1 list	grade 2 list
1 piece top - (2) full height stretchers centered under the top 	42 x 48	TLLOS42048 _ 2FCPV	2,760	3,130
	42 x 54	TLLOS42054 _ 2FCPV	2,900	3,290
	42 x 60	TLLOS42060 _ 2FCPV	3,030	3,460
	42 x 66	TLLOS42066 _ 2FCPV	3,160	3,610
	42 x 72	TLLOS42072 _ 2FCPV	3,400	3,880
	42 x 84	TLLOS42084 _ 2FCPV	3,650	4,170
	42 x 96	TLLOS42096 _ 2FCPV	3,910	4,480
	48 x 54	TLLOS48054 _ 2FCPV	2,900	3,290
	48 x 60	TLLOS48060 _ 2FCPV	3,030	3,460
	48 x 66	TLLOS48066 _ 2FCPV	3,160	3,610
	48 x 72	TLLOS48072 _ 2FCPV	3,400	3,880
	48 x 84	TLLOS48084 _ 2FCPV	3,510	4,010
	48 x 96	TLLOS48096 _ 2FCPV	3,910	4,480
	54 x 60	TLLOS54060 _ 2FCPV	4,020	4,570
	54 x 66	TLLOS54066 _ 2FCPV	4,180	4,760
	54 x 72	TLLOS54072 _ 2FCPV	4,340	4,950
	54 x 84	TLLOS54084 _ 2FCPV	4,450	5,090
	54 x 96	TLLOS54096 _ 2FCPV	4,570	5,240
2 piece top - (2) full height stretchers centered under each piece of the 	42 x 120	TLLOS42120 _ 2FCPV	5,940	6,620
	42 x 144	TLLOS42144 _ 2FCPV	6,590	7,360
	42 x 192	TLLOS42192 _ 2FCPV	7,880	8,910
	48 x 120	TLLOS48120 _ 2FCPV	5,940	6,620
	48 x 144	TLLOS48144 _ 2FCPV	6,590	7,360
	48 x 192	TLLOS48192 _ 2FCPV	7,990	9,020
	54 x 120	TLLOS54120 _ 2FCPV	6,910	7,700
	54 x 144	TLLOS54144 _ 2FCPV	7,390	8,270
	54 x 192	TLLOS54192 _ 2FCPV	8,850	10,020
	60 x 120	TLLOS60120 _ 2FCPV	7,150	7,930
	60 x 144	TLLOS60144 _ 2FCPV	7,620	8,500
	60 x 192	TLLOS60192 _ 2FCPV	9,080	10,250
3 piece top - (2) full height stretchers centered under each piece of the 	42 x 216	TLLOS42216 _ 2FCPV	8,850	10,000
	42 x 240	TLLOS42240 _ 2FCPV	9,490	10,780
	48 x 216	TLLOS48216 _ 2FCPV	8,850	10,000
	48 x 240	TLLOS48240 _ 2FCPV	9,490	10,780
	54 x 216	TLLOS54216 _ 2FCPV	10,250	11,640
	54 x 240	TLLOS54240 _ 2FCPV	10,980	12,520
	60 x 216	TLLOS60216 _ 2FCPV	10,480	11,870
	60 x 240	TLLOS60240 _ 2FCPV	11,210	12,750

**Wire Management Door option:**



**Losa wire management door with finger pull for 1 full height stretcher\*\***

(door dimensions: 10.5"W x 12.5"H) model # **OBOLOSWMD1** - \$200 list

**Losa wire management door with finger pull for 2 full height stretchers\*\***

(door dimensions: 10.5"W x 12.5"H) model # **OBOLOSWMD2** - \$400 list

**Losa wire management door with finger pull for 3 full height stretchers\*\***

(door dimensions: 10.5"W x 12.5"H) model # **OBOLOSWMD3** - \$600 list

\*\*specify placement and confirm which panel shall receive the door for tables with multiple stretchers

**Wire Management Mouse Hole options:**



Losa wire management mouse hole (1) stretcher at the top / center - model # **OBOLOSWMHMS** - \$20 list



Losa wire management mouse hole (1) in the end panel or middle support panel at the top / center - model # **OBOLOSWMHPT** - \$20 list



Losa wire management mouse hole (1) in the end panel or middle support panel at the bottom / center - model # **OBOLOSWMHPB** - \$20 list

**Wire Management cut out options for end /middle panels:**



Losa wire management notched cut out for power supply (1) stretcher at top / center model # **OBOLOSWMNCOS** - \$60 list



Losa wire management notched cut out for power supply (1) end panel or middle support panel at top / center model # **OBOLOSWMNCOP** - \$60 list



Losa wire management cut out (1) on the end panel 18" at center from the bottom center of the panel model # **OBOLOSWMCOEP** - \$60 list

\*\*specify which panel or stretcher shall have the mouse hole or cut out on your PO

Please contact [service@symphonytables.com](mailto:service@symphonytables.com) to make sure that your power and/or wire management solution will work with the Losa table specification. We are able to modify this table with a custom solution to fit your projects needs.